

PERI Bérleti kritériumok

MULTIPROP

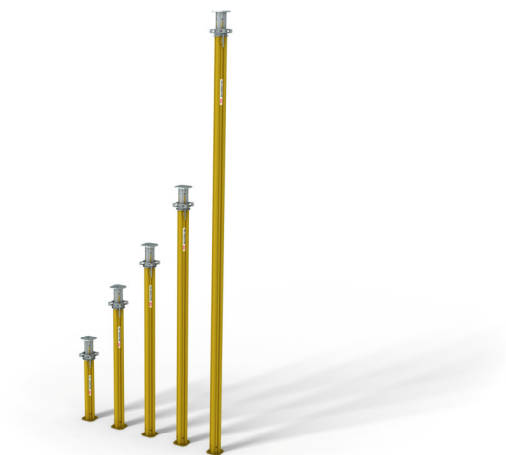

Kapcsolat

PERI Kft
Zsaluzatok, állványzatok,
mérnöki szolgáltatás

H-1180 Budapest
Zádor u. 9.
Tel.: +36-1-296-09-60
www.peri.hu

Tartalom	Oldal
MULTIPROP támasz	2
MRK keret	11
Kiegészítők	16
Magyarázat	36

Változások	Dátum ü	Oldal
Új verzió	09/2015 O.L.	

PERI Bérleti kritériumok

MULTIPROP





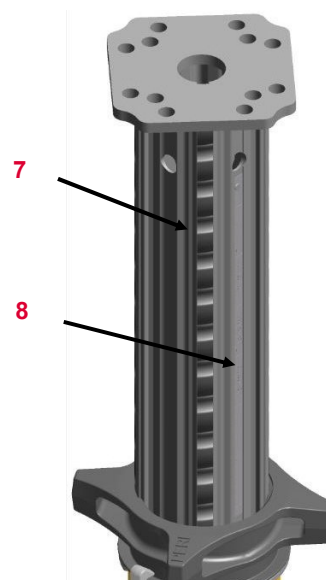
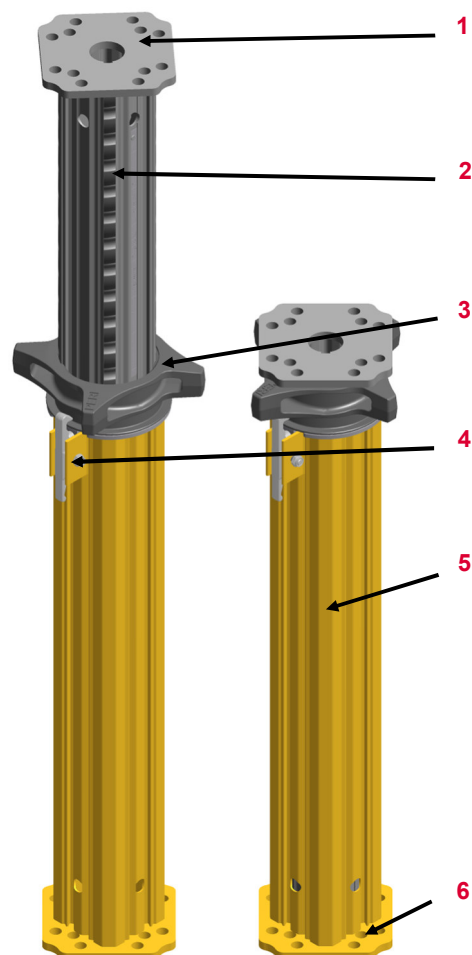

































MULTIPROP támasz



Sorszám	Megnevezés	Cikkszám
1	Fejlemez	
2	Belső cső	
3	Szintezőanya	710273
4	Szintezőanya rögzítőkapocs	710418
5	Kölső cső	
6	Talplemez	
7	Csavarmenet	
8	Perem	

Megnevezés	Cikkszám
MULTIPROP MP 120	027288
MULTIPROP MP 250	027289
MULTIPROP MP 350	027290
MULTIPROP MP 480	027291
MULTIPROP MP 625	027305















Támasz	Leírás	Instrukció	Fizetési kondíció	Típus
	20.05.01 Horpadás a külső csövön <ul style="list-style-type: none"> ■ Ha a belső cső nem mozgatható 		 088381	
	<ul style="list-style-type: none"> ■ Vagy ha a külső cső nem javítható, és a külső cső cseréje lehetséges 	 Külső cső csere	 Lásd táblázat (10. o.)	
	<ul style="list-style-type: none"> ■ Vagy a csere nem lehetséges 			
	20.05.02 Horpadás a belső csőben <ul style="list-style-type: none"> ■ Cső nem mozgatható 	 Belső cső csere	 (p. 10)	
	<ul style="list-style-type: none"> ■ Vagy > 2 mm a csavarmeneten, és ha javítható ■ Vagy > 3 mm a perem területén 	 Belső cső csere	 (p. 10)	
	<ul style="list-style-type: none"> ■ Vagy ha nem lehetséges a javítás 			

Támasz	Leírás	Instrukció	Fizetési kondíció	Típus
	25.05.03 Erősen szennyezett belső cső, vagy mérőszalag <ul style="list-style-type: none"> ■ Ha lehetséges 			
	<ul style="list-style-type: none"> ■ Vagy ha nem lehetséges ■ Vagy a mérőszalag hiányzik vagy törött 		Cserélje ki a mérőszalagot vagy a csövet	 Lásd (10. o.)
	25.05.04 Csúsztatható elem laza		 088380	
	25.05.05 Lyuk a külső csövön <ul style="list-style-type: none"> ■ $\leq \varnothing 5 \text{ mm}$ 	 		
	<ul style="list-style-type: none"> ■ $> \varnothing 5 \text{ mm}$ 		Külső cső cseréje	 Lásd (10. o.)

PERI Bérleti kritériumok

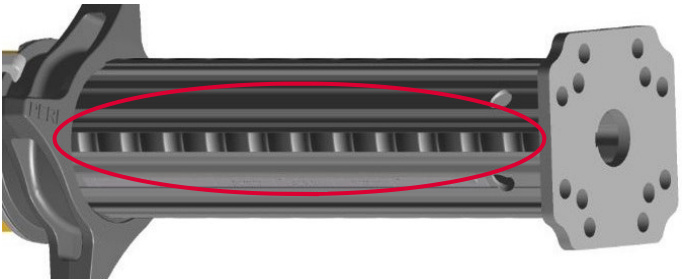
MULTIPROP











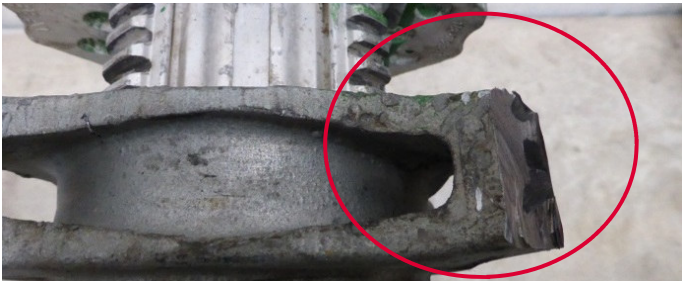





Támasz	Leírás	Instrukció	Fizetési kondíció	Típus	
	20.05.06 Fej- vagy talplemez deformálódott <ul style="list-style-type: none"> ■ Deformáció 20 mm-ig 				
	<ul style="list-style-type: none"> ■ Vagy a deformáció > 20 mm 		Belső vagy külső cső csere	 Lásd (1 o.o)	
	20.05.07 Repedés a hegesztésben		Belső vagy külső cső csere	 Lásd (10. o)	
	20.05.08 Csavarmenet betonnal szennyezett				

PERI Bérleti kritériumok

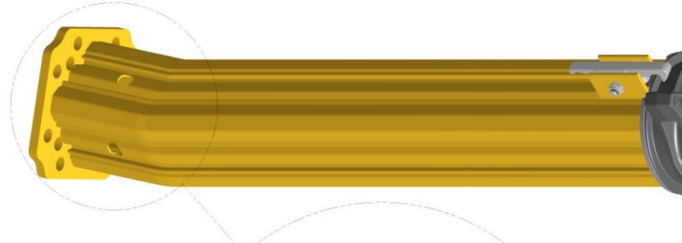
MULTIPROP



Támasz	Leírás	Instrukció	Fizetési kondíció	Típus
	20.05.09 Szintezőanya <ul style="list-style-type: none"> ■ Fülek eltörtek 		 088378	
	<ul style="list-style-type: none"> ■ Vagy repedés a szintezőanyagban 		 088378	
	20.05.10 A rögzítőkapocs sérült, nem használható		 088372	
	20.05.11 A teljes támasz meghajlítva <ul style="list-style-type: none"> ■ A cső nem mozgatható 			

PERI Bérleti kritériumok MULTIPROP



Támasz	Leírás	Instrukció	Fizetési kondíció	Típus
--------	--------	------------	-------------------	-------



20.05.52 Repedés a
szintezőnyában



710273



Új verzió : (2015 óta)

Régi verziói 2015-ig



PERI Bérleti kritériumok MULTIPROP



Támasz	Leírás	Instrukció	Fizetési kondíció	Típus
--------	--------	------------	-------------------	-------



20.05.53 Utángyártott Multiprop támasz

- Szintező anyában azonosító jel (PERI felirat lenyomata látható)



PERI Bérleti kritériumok

MULTIPROP



Támasz	Leírás	Instrukció	Fizetési kondíció	Típus
	20.53.56 Támasz fej- / talplemez repedt / bevágott / törött	 Belső vagy külső cső csere		

PERI Bérleti kritériumok

MULTIPROP



Termék	Mérőszalag csere		Külső cső csere		Belső cső csere	
	Alkatrészek	Szervíz cikkszám	Alkatrészek	Szervíz cikkszám	Alkatrészek	Szervíz cikkszám
MULTIPROP MP 120	710421	088370	702048	088401	702050	088400
MULTIPROP MP 250	710406	088374	702038	088403	702040	088402
MULTIPROP MP 350	710414	088375	702029	088405	702028	088404
MULTIPROP MP 480	710407	088376	702034	088407	720606	088406
MULTIPROP MP 625	720609	088373	720603	088409	720606	088408

PERI Bérleti kritériumok

MULTIPROP



MULTIPROP MRK keret

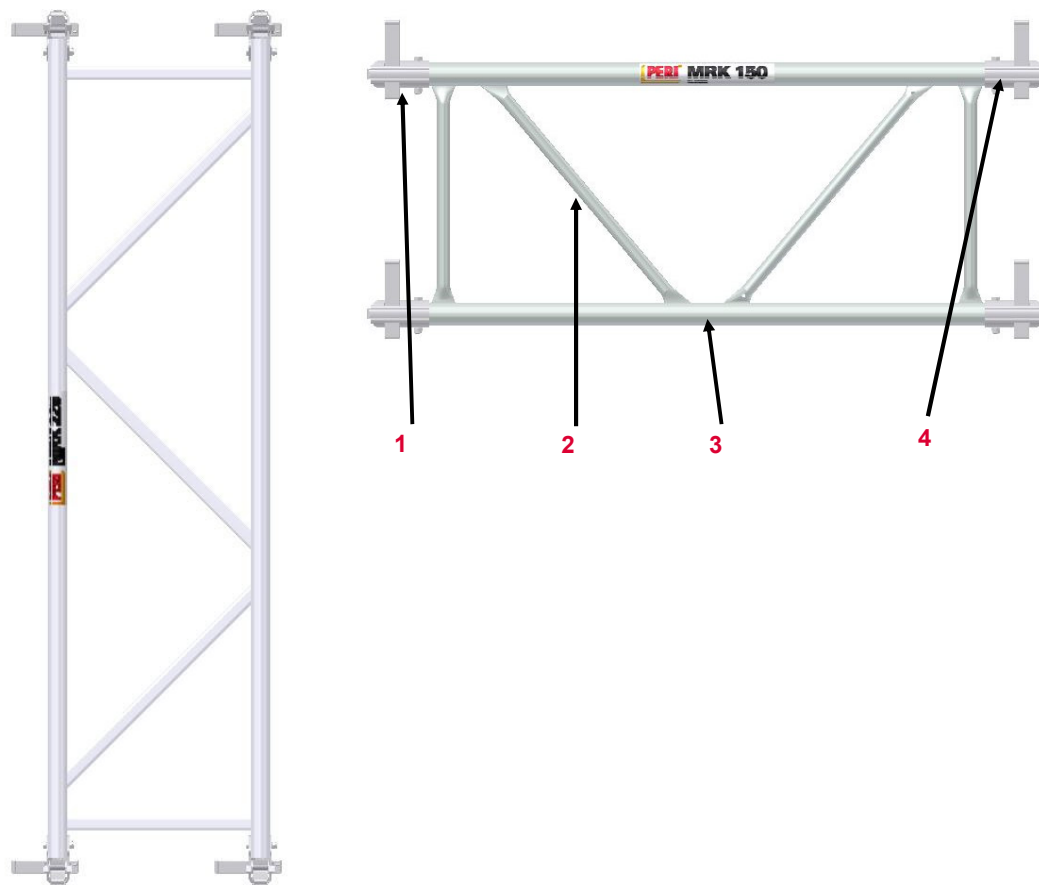









Sorszám	Megnevezés	Cikkszám
1	MRK ékes rögzítőfej –C kpl	105881
2	Átlós merevítő	
3	Keret	
4	MRK ékes rögzítőfej –D kpl	105874

Megnevezés	Cikkszám
Keret MRK 62,5	028390
Keret MRK 75	028400
Keret MRK 90	028330
Keret MRK 120	028340
Keret MRK 137,5	028380
Keret MRK 150	028350
Keret MRK 201,5	028460
Keret MRK 225	028360
Keret MRK 230	028470
Keret MRK 237	028480
Keret MRK 266	028490
Keret MRK 296	028370

PERI Bérleti kritériumok

MULTIPROP



MRK keret	Leírás	Instrukció	Fizetési kondíció	Típus
	20.05.12 A rögzítőfej nem funkcionál (a támasz továbbra is mozog)	 105881 (MRK ékes rögzítőfej –C kpl) 105874 (MRK ékes rögzítőfej –D kpl)		
	20.05.13 Meghajlott külső héj a csatlakozón	 105881 (MRK ékes rögzítőfej –D kpl) 105874 (MRK ékes rögzítőfej –D kpl)	 088379	

MRK keret	Leírás	Instrukció	Fizetési kondíció	Típus
-----------	--------	------------	-------------------	-------

20.05.14 Keret elgörbült



- \leq Engedélyezett görbület (l/500)



- Vagy $>$ engedélyezett görbület













Termék	Eng. görb.
MRK Keret 62,5	3,0 mm
MRK Keret 75	3,0 mm
MRK Keret 90	3,0 mm
MRK Keret 120	3,0 mm
MRK Keret 137,5	3,0 mm
MRK Keret 150	3,0 mm
MRK Keret 201,5	4,0 mm
MRK Keret 225	4,5 mm
MRK Keret 230	4,5 mm
MRK Keret 237	5,0 mm
MRK Keret 266	5,0 mm
MRK Keret 296	6,0 mm



PERI Bérleti kritériumok

MULTIPROP

















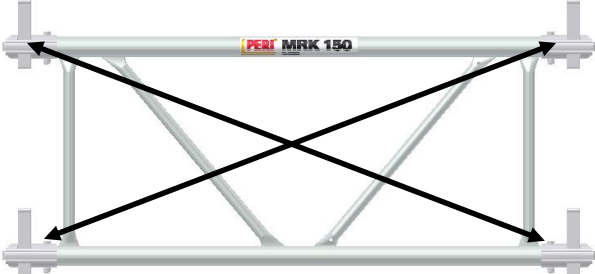

MRK keret	Leírás	Instrukció	Fizetési kondíció	Típus
	20.05.15 Ék rozsdás elkopott <ul style="list-style-type: none"> ■ Nem működőképes 	 105881 (MRK ékes rögzítőfej –C kpl) 105874 (MRK ékes rögzítőfej –D kpl)		
	20.05.16 Repedés a hegesztésben <ul style="list-style-type: none"> ■ Deformáció nélkül ■ Vagy deformációval 	 	 	 

PERI Bérleti kritériumok

MULTIPROP



MRK keret	Leírás	Instrukció	Fizetési kondíció	Típus
	20.05.54 Merevítő deformálódott <ul style="list-style-type: none"> ■ Ha lehetséges 			
	<ul style="list-style-type: none"> ■ Vagy a merevítő szélei érintettek 			
	<ul style="list-style-type: none"> ■ Vagy a merevítő törött 			
	20.05.55 MRK átlósan görbült <ul style="list-style-type: none"> ■ Ha lehetséges 			
	<ul style="list-style-type: none"> ■ Ha nem lehetséges 			

PERI Bérleti kritériumok

MULTIPROP



MULTIPROP MP 50 TÁMASZTOLDÓ (027310)	Leírás	Instrukció	Fizetési kondíció	Típus
--------------------------------------	--------	------------	-------------------	-------



20.05.17 Cső hajlított

- ≤ 6 mm mélység $\leq \varnothing 60$ mm
- Vagy > 6 mm mélyég
- Vagy $> \varnothing 60$ mm

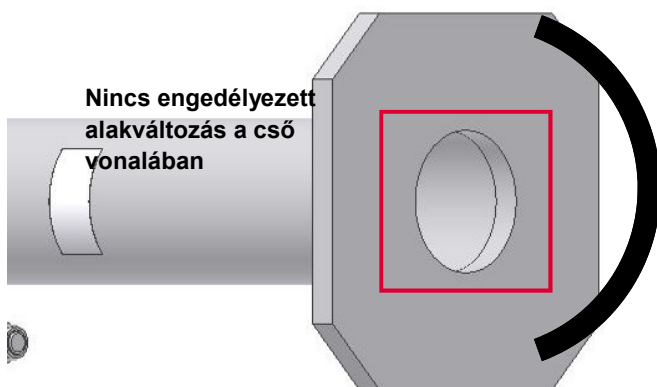

20.05.18 A fej vagy a talp hajlított

- ≤ 15 mm
- Vagy > 15 mm

















088244



PERI Bérleti kritériumok

MULTIPROP











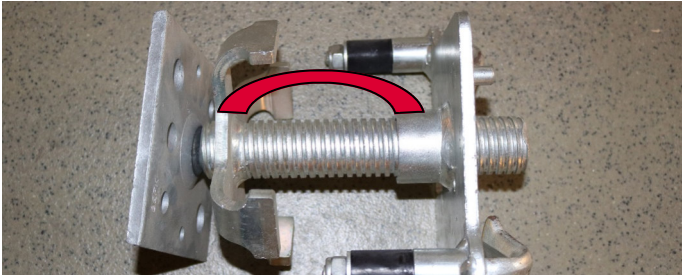



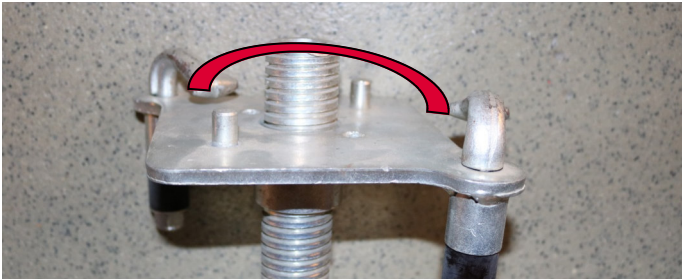

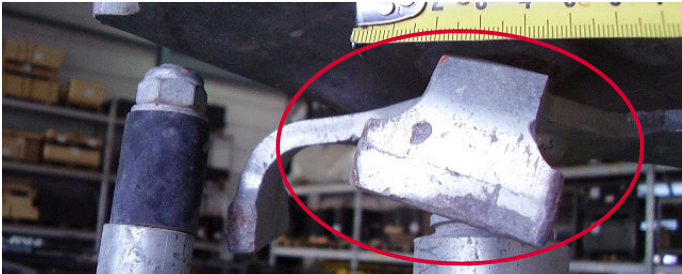

MP 50 támasztoldó (027310)	Leírás	Instrukció	Fizetési kondíció	Típus
	<p>20.05.19 Rugós cső deformált, hiányzik</p> <ul style="list-style-type: none"> ■ Rugós cső 1. verzió (fekete) ■ Vagy a rugós cső 2. verzió (narancssárga) 	 	  088367	 
	<p>20.05.20 A feszítő karom sérült, hiányzik</p>		 088368	
	<p>20.05.21 A feszítő karom nincs meghúzva</p> <ul style="list-style-type: none"> ■ A feszítő karomnak ellenállással kell bírnia, mikor kézzel mozgatja 			

PERI Bérleti kritériumok

MULTIPROP

















Gömbcsuklós talp MKF (027296)	Leírás	Instrukció	Fizetési kondíció	Típus
	<p>20.05.22 Orsó meghajlott</p> <ul style="list-style-type: none"> ■ > 5 mm 			
	<p>20.05.23 Fej vagy az alaplap lemez deformálódott</p> <ul style="list-style-type: none"> ■ > 5 mm ■ Ha nem lehetséges 	<p>  Ha lehetséges  </p>	<p>  088244  </p>	<p>   </p>
	<p>20.05.23 Forgórész deformálódva</p> <ul style="list-style-type: none"> ■ A forgórész repedése nélkül ■ Ha nem lehetséges, vagy a forgórész repedésével 	<p>  Ha lehetséges  </p>	<p>  088244  </p>	<p>   </p>

PERI Bérleti kritériumok

MULTIPROP











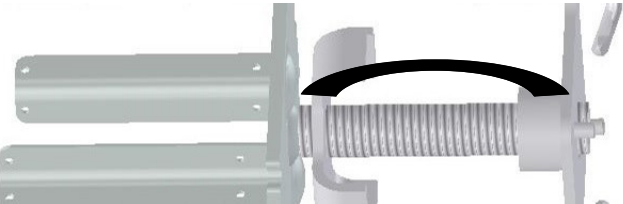













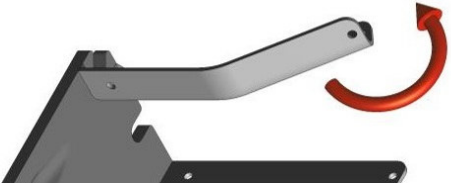













Gömbcsuklós talp MKF (027296)	Leírás	Instrukció	Fizetési kondíció	Típus
	<p>20.05.25 Rugós cső deformált, hiányzik</p> <ul style="list-style-type: none"> ■ Rugós cső 1. verzió (fekete) ■ Vagy a rugós cső 2. verzió (narancssárga) 	 	 088367 	 
	<p>20.05.26 A feszítő karom sérült, hiányzik</p>		 088268	
	<p>20.05.27 A feszítő karom nincs meghúzva</p> <ul style="list-style-type: none"> ■ A feszítő karomnak ellenállással kell bírnia, mikor kézzel mozgatja 			

PERI Bérleti kritériumok

MULTIPROP



Gömbcsuklós keresztfej MKK (027297)	Leírás	Instrukció	Fizetési kondíció	Típus
	<p>20.05.28 Orsó hajlított</p> <ul style="list-style-type: none"> ■ > 5 mm 			
	<p>20.05.29 Fej- vagy talplemez deformálódott</p> <ul style="list-style-type: none"> ■ > 5 mm 			
	<p>20.05.30 Forgórész elgörbülve</p> <ul style="list-style-type: none"> ■ Forgórész repedése nélkül ■ Ha nem lehetséges, vagy a forgórész repedésével 	 Ha lehetséges 	 088244  088244	 
	<p>20.05.31 Vezető támasztó fül elgörbült</p> <ul style="list-style-type: none"> ■ Hegesztés repedése nélkül ■ Vagy a hegesztés repedésével 	 	 088395  088394	 

Gömcsuklós keresztfej MKK (027297)	Leírás	Instrukció	Fizetési kondíció	Típus		
	20.05.32 Rugós cső deformált, hiányzik					
	<ul style="list-style-type: none"> ■ Rugós cső 1. verzió (fekete) ■ Vagy a rugós cső 2. verzió (narancssárga) 	 	 	 088367	 	
	20.05.33 A feszítő karom sérült, hiányzik		780108 (rugós cső) 780105 (feszítő karom) 710381 (anya) 780702 (alátét 2x)		088368	
	20.05.34 feszítő karom nincs meghúzva					
	<ul style="list-style-type: none"> ■ A feszítő karomnak ellenállással kell bírnia, mikor kézzel mozgatja 					

PERI Bérleti kritériumok

MULTIPROP



Háromláb univerzális (028000)

Sorszám Megnevezés Cikkszám

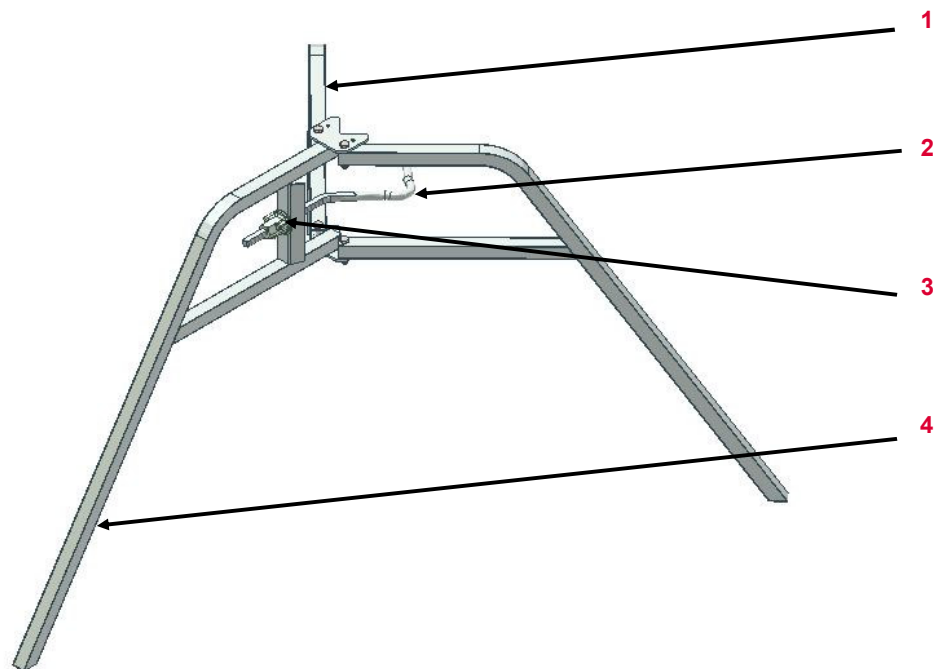

1	Forgó láb	715643
2	Menetes rögzítőhorog	710161
3	Bütykös anya	030130
4	Támasztóláb	715642

PERI Bérleti kritériumok

MULTIPROP











Univerzális háromláb	Leírás	Instrukció	Fizetési kondíció	Típus
	<p>20.05.35 Forgó láb elgörbült</p> <ul style="list-style-type: none"> ■ Ha egyengetés lehetséges ■ Vagy ha nem lehetséges 	<ul style="list-style-type: none">  088244  715643 (Forgó láb) 	<ul style="list-style-type: none">  088244  089149 	<ul style="list-style-type: none">  
	<p>20.05.36 Támasztó láb elgörbült</p> <ul style="list-style-type: none"> ■ Ha lehetséges ■ Ha nem lehetséges 	<ul style="list-style-type: none">   	<ul style="list-style-type: none">  088244  	<ul style="list-style-type: none">  

PERI Bérleti kritériumok

MULTIPROP



Univerzális háromláb	Leírás	Instrukció	Fizetési kondíció	Típus
	<p>20.05.37 Rögzítő horog deformálódott</p> <p>■ > 93°</p>			
	<p>20.05.38 Büttykösanya rongálódott</p>	 030130 (Büttykös anya) 767043 (Szegecs)	 088429	

PERI Bérleti kritériumok

MULTIPROP



Multiprop MG állványcső kapcsoló

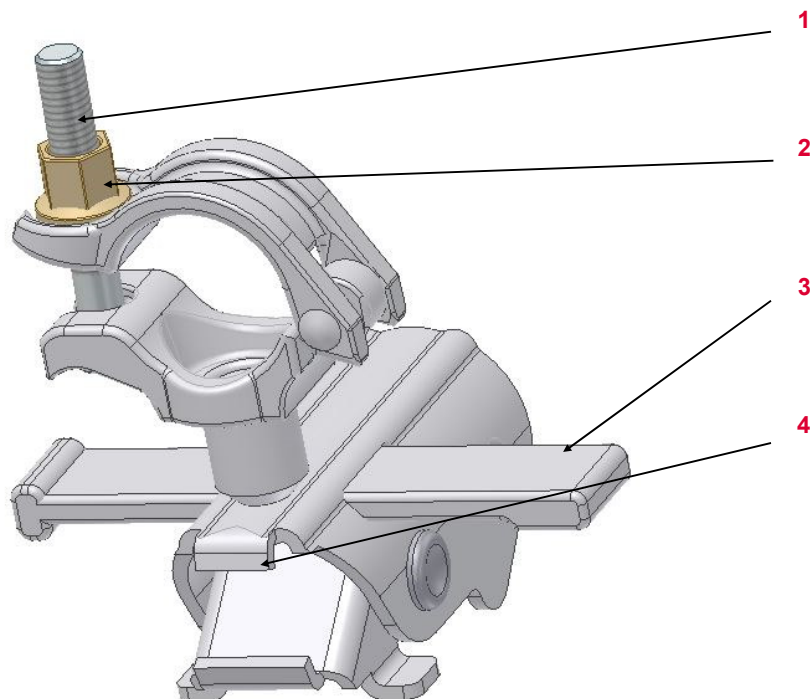











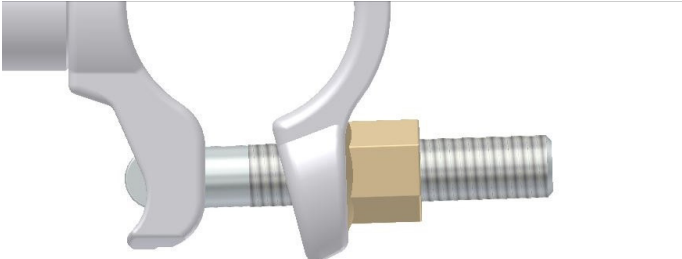

Sorszám	Megnevezés	Cikkszám
1	Kalapácsfejű csavar	710702
2	Anya	710340
3	Ék	
4	Csatlakozó	

Megnevezés	Cikkszám
Állványcső kapcs. MG-A/C	027298
Állványcső kapcs. MG-B/D	027299

PERI Bérleti kritériumok

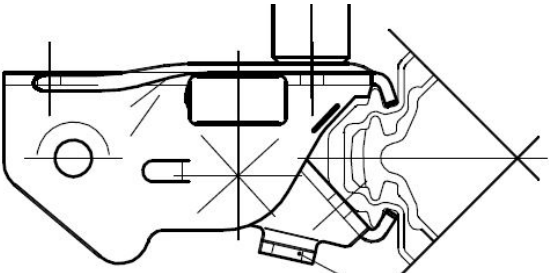
MULTIPROP



Állványcső kapcsoló	Leírás	Instrukció	Fizetési kondíció	Típus
	20.05.39 Kalapácsfejű csavar hiányzik	 710702 (Kalapácsfejű csavar) 710340 (Anyá)	 088388 088360	
	20.05.40 Az ék nem megfelelően funkcionál			
	20.05.41 A Multiprop támaszhoz való csatlakozás nem lehetséges			

PERI Bérleti kritériumok

MULTIPROP



Gyorskapcsoló MPV-2 (027301)	Leírás	Instrukció	Fizetési kondíció	Típus
------------------------------	--------	------------	-------------------	-------



20.05.42 Csap vagy állítócsavar hiányzik



20.05.43 Hajlított, deformált



PERI Bérleti kritériumok

MULTIPROP



MULTIPROP hevederrögítő (027302)	Leírás	Instrukció	Fizetési kondíció	Típus
----------------------------------	--------	------------	-------------------	-------



20.05.44 Konzol hajlítva, hiányzik



20.05.45 Szorítókegyel hajlított

■ > 10 mm



PERI Bérleti kritériumok

MULTIPROP



Lekötés MPB 24/GT24 (111000)	Leírás	Instrukció	Fizetési kondíció	Típus
------------------------------	--------	------------	-------------------	-------

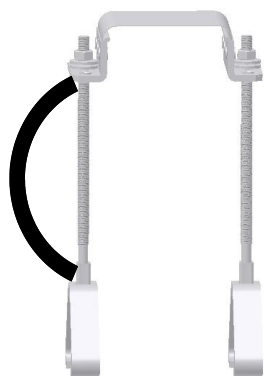

20.05.46 A csavar elgörbült

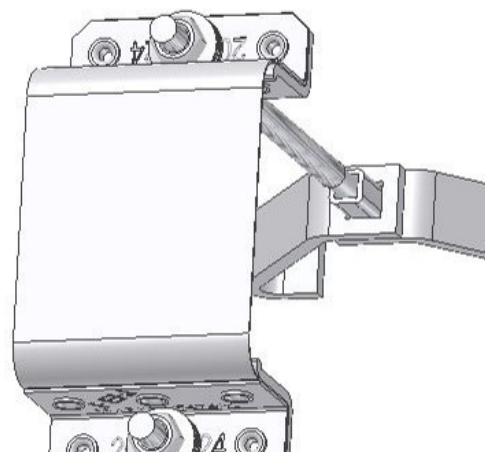

20.05.47 A lemez sérült, deformálódott



PERI Bérleti kritériumok

MULTIPROP



Aluminium gerenda MPB 24

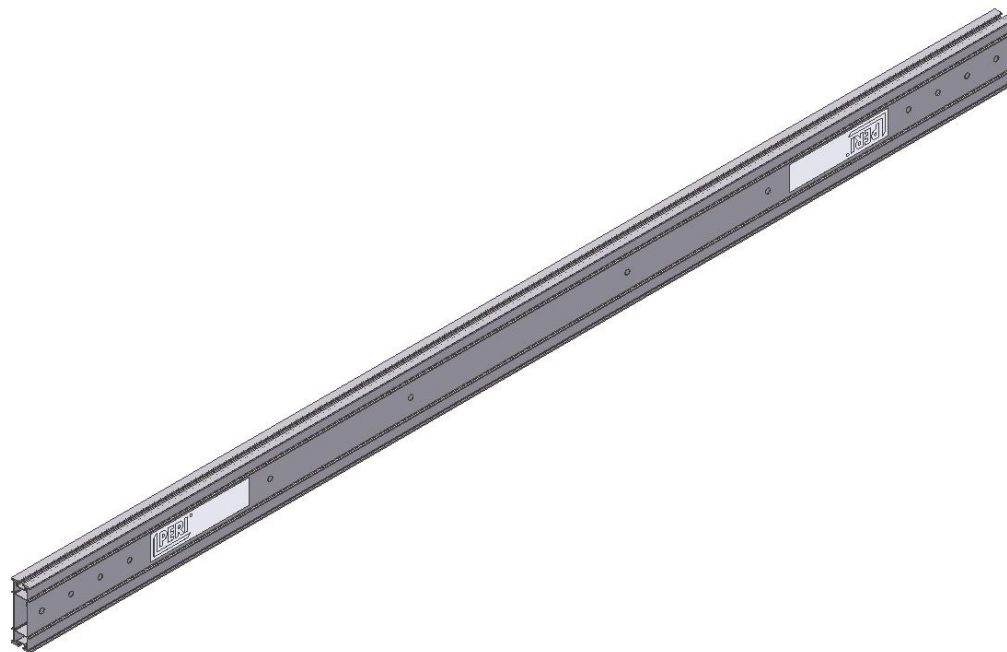



Sorszám	Megnevezés	Cikkszám
---------	------------	----------

Megnevezés	Cikkszám
Gerenda MPB 24, L= 3,00 m	079300
Gerenda MPB 24, L= 3,60 m	079360
Gerenda MPB 24, L= 4,20 m	079420
Gerenda MPB 24, L= 4,80 m	079480
Gerenda MPB 24, L= 5,40 m	079540
Gerenda MPB 24, L= 6,00 m	079600

PERI Bérleti kritériumok

MULTIPROP



MPB gerenda	Leírás	Instrukció	Fizetési kondíció	Típus
	<p>20.05.48 Szöglyukak</p> <ul style="list-style-type: none"> ■ ≤ Ø 5 mm ■ Vagy > Ø 5 mm 	<p>✓</p> <p>☒</p>	<p>☒</p> <p>☒</p>	<p>👁️</p> <p>⚖️</p>
	<p>20.05.49 Megrövidített gerenda</p>	<p>☒</p>	<p>☒</p>	<p>👁️</p>

PERI Bérleti kritériumok

MULTIPROP



MPB gerenda	Leírás	Instrukció	Fizetési kondíció	Típus
-------------	--------	------------	-------------------	-------

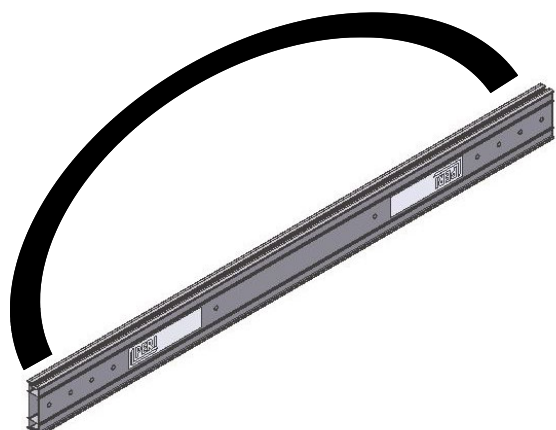

20.05.50 Gerenda görbült

■ ≤ megengedett görbület



■ Vagy > megengedett görbület













Cikkek	Megeng. Görb.
MPB 24, L= 3,00 m	6,0 mm
MPB 24, L= 3,60 m	7,0 mm
MPB 24, L= 4,20 m	9,0 mm
MPB 24, L= 4,80 m	9,5 mm
MPB 24, L= 5,40 m	11,0 mm
MPB 24, L= 6,00 m	12,0 mm

PERI Bérleti kritériumok

MULTIPROP



MPB gerenda	Leírás	Instrukció	Fizetési kondíció	Típus
	<p>20.05.57 Szennyezett vezetőprofil</p> <ul style="list-style-type: none"> ■ Ha lehetséges ■ Vagy ha már nem lehetséges 	 	 	 
	<p>20.05.58 Repedések a belső profilban</p>			

PERI Bérleti kritériumok

MULTIPROP



MPB gerenda	Leírás	Instrukció	Fizetési kondíció	Típus
	25.05.59 Repedések a külső profilban			

PERI Bérleti kritériumok

MULTIPROP



Kupplung MPB (107348)	Leírás	Instrukció	Fizetési kondíció	Típus
-----------------------	--------	------------	-------------------	-------

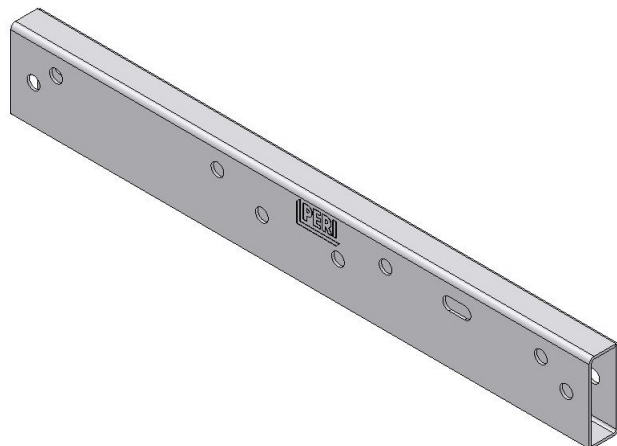

















20.05.51 Összekötés deformálódott



PERI Bérleti kritériumok

Magyarázat



Ikon	Jelentés	Ikon	Jelentés	Ikon	Jelentés
	Nem OK — kicselezendő		Ügyfélnek leszámházandó		Optikai kár
	OK– marad a bérleti parkban		Nincs számházás		Funkcionális sérülés
	Selejt anyag – biztonsági okokból az anyagot tilos kiadni		Anyagot levágni		Funkcionális sérülés — anyag kiadása nem engedélyezett
	Javítás az előírások szerint		Anyagot megjelölni		Statikai sérülés — anyag kiadása nem engedélyezett
	Hideg egyengetés — utána a varratokat és a környékét ellenőrzni kell		Sérült anyag cseréje		
	Javítás gazdaságosság függvényében		Hiányzó anyag pótlása		
	Megtisztítani az anyagot				