

PERI Bérleti kritériumok

TRIO

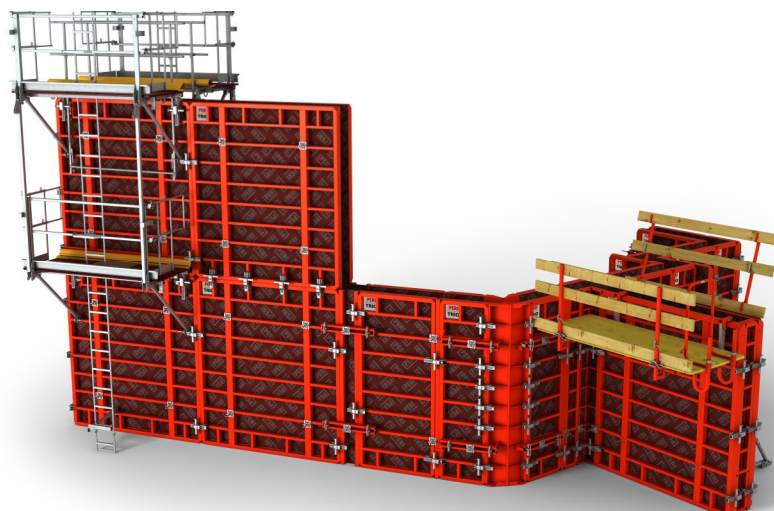

PERI kft.

Zsaluzatok, állványzatok,
mérnöki szolgáltatás

H-1181 Budapest, Zádor u. 9.

Tel.: +36-1-296-09-60
www.peri.hu

Tartalom	Oldal	Változás	Dátum üi	Oldal
Acél keret sérülése	2	Új verzió	02/2021 O.L.	
TRIO csuklós sarok	13	Oldalak hozzáadva (11.; 34)	06/2022 V.A.	
TRIO sarok elem	16			
WDA falbetétek	18			
Végzáró elem	22			
BFD kapocs	26			
TRIO betonozó konzol	27			
Tartozékok	30			

PERI Bérleti kritériumok

TRIO



TRIO keret	No.	Név	Cikkszám
------------	-----	-----	----------

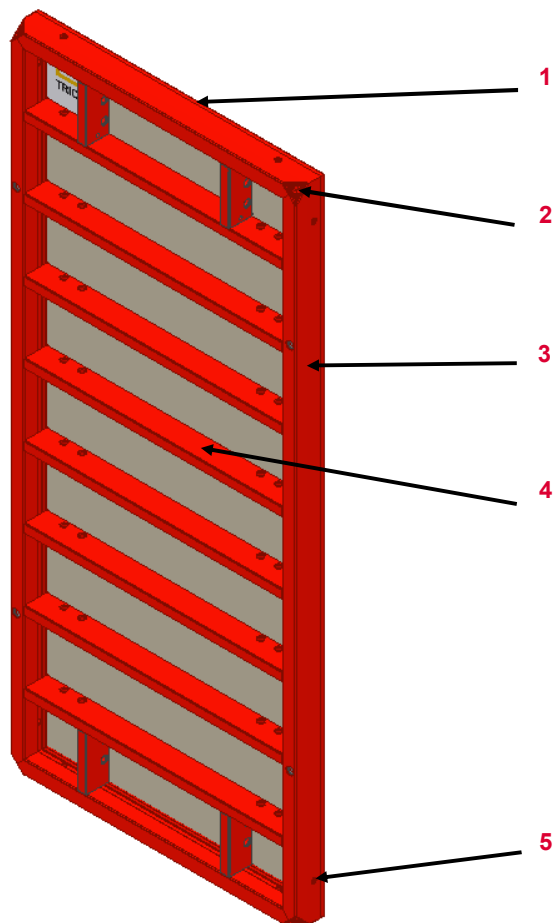

1	Rövid oldalprofil	
2	TR háromszög	750580
3	Hosszú oldalprofil	
4	Merevítő borda	
5	Fémpersey	750127

PERI Bérleti kritériumok

TRIO











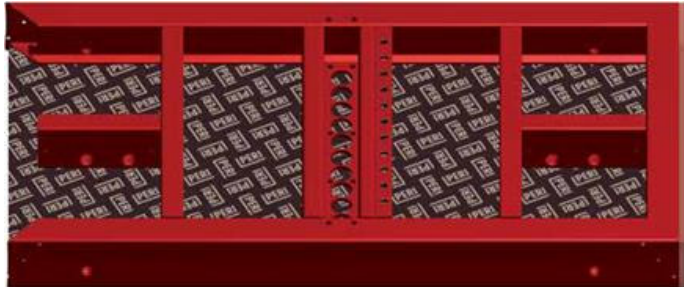

Termék	Cikkszám
Elem TR/4 330x240	054304
Elem TR/4 330x120	054314
Elem TR/4 330x90	054324
Elem TR/4 330x72	054334
Elem TR/4 330x60	054354
Elem TR/4 330x30	054364
Elem TRM/4 330x72	054344
Végzáró elem TR/4 330x24	023050
Elem TR 270x240	022570
Elem TR 270x120	022510
Elem TR 270x90	022520
Elem TR 270x72	022530
Elem TR 270x60	022550
Elem TR 270x30	022560
Elem TRM 270x 72	022540
Végzáró elem TR 270x24	023040

















Termék	Cikkszám
Elem TR 120x240	022514
Elem TR 120x120	022600
Elem TR 120x90	022610
Elem TR 120x72	022620
Elem TR 120x60	022640
Elem TR 120x30	022650
Elem TRM 120x72	022630
Végzáró elem TR 120x24	023030
Elem TR60x90	022790
Elem TR60x72	022800
Elem TR60x60	022810
Elem TR60x30	022820















PERI Bérleti kritériumok

TRIO



Keret sérülések	Leírás	Javítás	Számlázás	típus
	<p>27.01 Az oldalprofil vagy merevítő borda kitört</p>			
	<p>27.02 Rövid oldalprofil eldeformálódott</p> <ul style="list-style-type: none"> ■ Emelő horog által okozott benyomódás ■ Erőszakos hatás okozta sérülés 		 Lásd táblázat (11 old.)	
			 Lásd táblázat (11 old.)	

Keret sérülések	Leírás	Javítás	Számlázás	típus	
	27.03 Hosszú oldalprofil eldeformálódott				
	<ul style="list-style-type: none"> ■ Pl. emelő horog által okozott nyomódás. 				
	27.04 Lyukak az elemben				
	<ul style="list-style-type: none"> ■ $\leq \varnothing 3$ cm 			088028	
	<ul style="list-style-type: none"> ■ vagy $> \varnothing 3$ cm a hossz oldalprofilon 			Lásd táblázat (11+ 12 old.)	
<ul style="list-style-type: none"> ■ vagy $> \varnothing 3$ cm a rövid oldalprofilon vagy a merevítő bordán 					

Keret sérülések	Leírás	Javítás	Számlázás	típus
	27.05 Horpadás a merevítőbordán		 Lásd táblázat (12 old.)	
	27.06 A fémpersely eldeformálódott, kiszakadt		 088244	
	<ul style="list-style-type: none"> ■ Amennyiben vissza lehet hajlítani 		 Lásd táblázat (12 old.)	
	<ul style="list-style-type: none"> ■ Ha a visszahajlítás nem lehetséges 		 Lásd táblázat (12 old.)	
	<ul style="list-style-type: none"> ■ Kiszakadt persely 			

Keret sérülések	Leírás	Javítás	Számlázás	típus
-----------------	--------	---------	-----------	-------

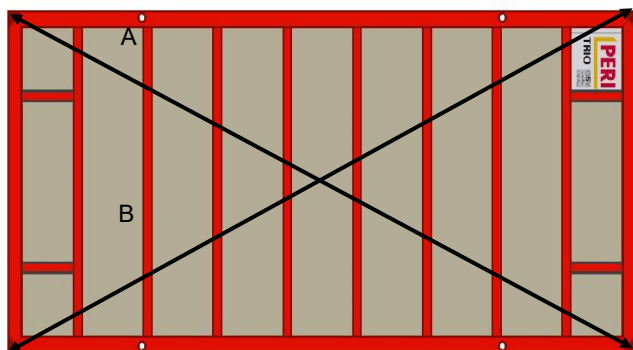

27.07 Az elem az átlón mérve elgörbült, ellenőrzés diagonál méréssel

- Különbség A és B között > 6 mm



Take both sides of trade fairs and average: $(a+b)/2$

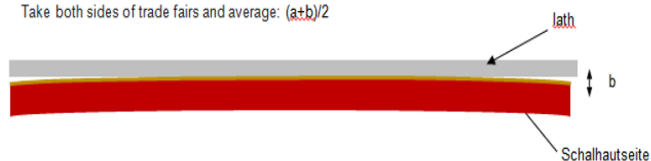

27.08 Elem deformálódott, mérés alu léccel

A 3 eset mérésekor:

- $(a + b) / 2 > 8 \text{ mm}$
- $a > 8 \text{ mm}$
- $a > 8 \text{ mm}$



Stich messen:

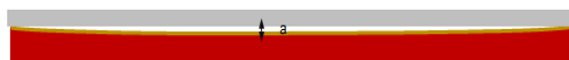



























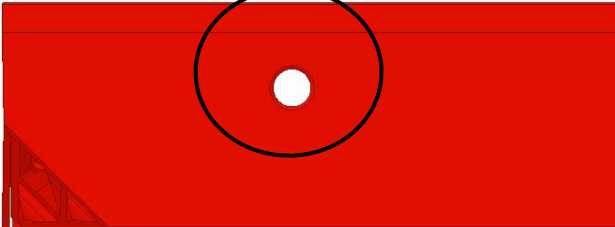

Bent only on one side:



Figyelem a 3. eset a tábla 2/3 hosszában egyenest feltételez, csak a tábla végi elhajlást szimbolizálja!

Keret sérülések	Leírás	Javítás	Számlázás	típus	
	27.09 A profil behorpadt	<ul style="list-style-type: none"> ■ ≤ 8 mm mély 			
	<ul style="list-style-type: none"> ■ vagy > 8 mm mély 			088027	
	27.10 A profil éle behorpadt	<ul style="list-style-type: none"> ■ < 3 mm 			
	<ul style="list-style-type: none"> ■ > 3 mm ≤ 10 mm 			088236	
	<ul style="list-style-type: none"> ■ ha > 10 mm 		Zsaluhéj ki-, beszerelés		088236

Keret sérülések	Leírás	Javítás	Számlázás	típus
	<p>27.11 Repedés a sarok hegesztésnél</p>			
	<p>27.12 Repedés a profil élen</p>			
	<ul style="list-style-type: none"> ■ Profil él elgörbült 		 088028	
	<ul style="list-style-type: none"> ■ Profil él sérülése nélkül 			

Keret sérülések	Leírás	Javítás	Számlázás	típus
	27.13 TR háromszög eldeformálódott		 088176	
	27.14 Persely hiányzik, sérült		 Lásd táblázat (11 old.)	
	<ul style="list-style-type: none"> ■ Amennyiben rövid oldalprofil érint profilcsere ■ Amennyiben hosszú oldalprofil érint kényszereladás 		 Lásd táblázat (11 old.)	
	27.15 Rozsda által keletkezett lyuk a kereten			
	<ul style="list-style-type: none"> ■ Teszt 300 g kalapáccsal 			

Keret sérülések	Leírás	Javítás	Számlázás	típus
	<p>27.16 Szeg által keletkezett lyukak</p>			
	<p>27.17 Horpadás és lyuk (illetve több lyuk egy kisebb területen)</p>			
	<p>27.18 Ha Ø > mint 5 mm</p>			

PERI Bérleti kritériumok

TRIO



Termék	Oldal profil	
	Javító alkatrész	Javítási szervíz szám
oldalprofil 30	109106	088049
oldalprofil 60	109031	088051
oldalprofil 72	109025	088224
oldalprofil 90	109023	088052
oldalprofil 120	109021	xxxxxx
oldalprofil 240	745051	xxxxxx
oldalprofil 270	745050	xxxxxx
oldalprofil 330	105268 bal; 105267 jobb;	xxxxxx

PERI Bérleti kritériumok

TRIO



Termék	Merevítő	
	Javító alkatrész	Javítási cikkszám
Merevítő borda 18	745357	088038
Merevítő borda 19	112479	088039
Merevítő borda 22	745356	088040
Merevítő borda 43	745355	088043
Merevítő borda 48	745354	088044
Merevítő borda 78	745352	088046
Merevítő borda 122	745350	088047
Merevítő borda 60	745353	088232
Merevítő borda 23	745358	

PERI Bérleti kritériumok

TRIO



TRIO csuklós sarok TGE

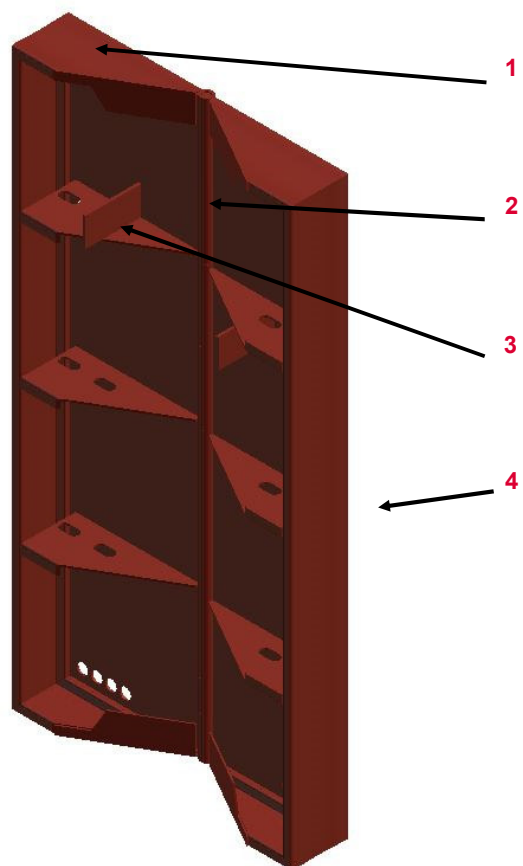

Sorszám	Név	Cikkszám
1	Talplemez	722066
2	Zsanér	
3	Rakat képző	740211
4	Zsaluzó felület	

Vonatkozó termék	Cikkszám
Csuklós sarok TGE 330	054414
Csuklós sarok TGE 270	023200
Csuklós sarok TGE 120	023300

TGE	Leírás	Javítás	Számlázás	típus
	27.28 Benyomódás vagy horpadás a profilon vagy a zsaluhéjon			
	<ul style="list-style-type: none"> ■ ≤ 3 mm 			
	<ul style="list-style-type: none"> ■ vagy > 3—10 mm-ig 			
	<ul style="list-style-type: none"> ■ vagy > 10 mm 			
	27.29 Keret átlón mérve elgörbült			
	<ul style="list-style-type: none"> ■ Különbség A és B között > 5 mm 			

TGE	Leírás	Javítás	Számlázás	típus
-----	--------	---------	-----------	-------

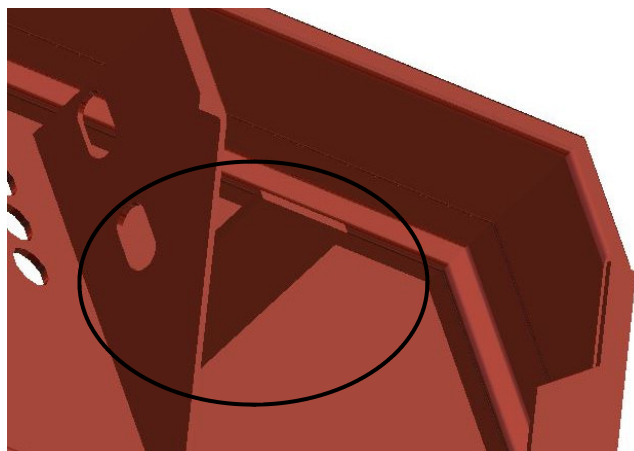

27.30 Rakat képző elgörbült



088244

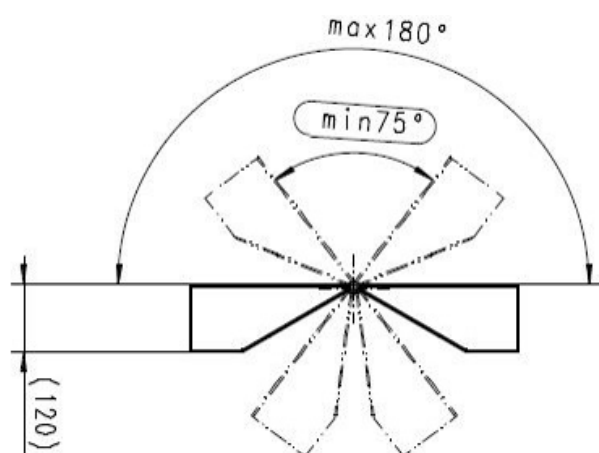

27.31 Nem lehet összehajtani

- Az elem nehezen mozog



Végezetül beolajozni a pántot



- Nem lehet összehajtani



- Tisztítás és javítás után sem működik



PERI Bérleti kritériumok

TRIO





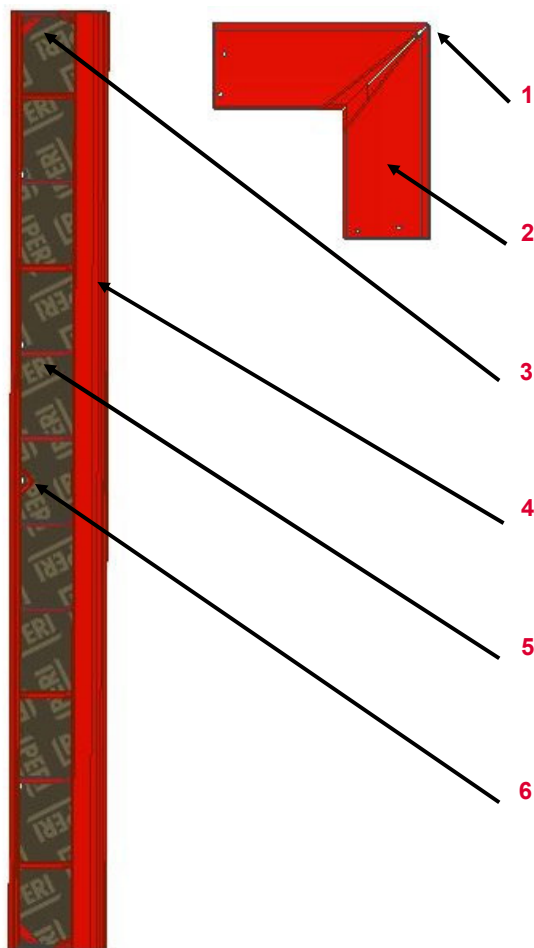



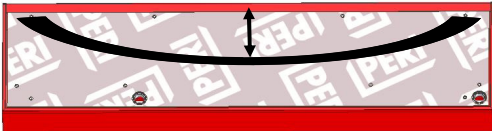

TRIO TE sarokelem

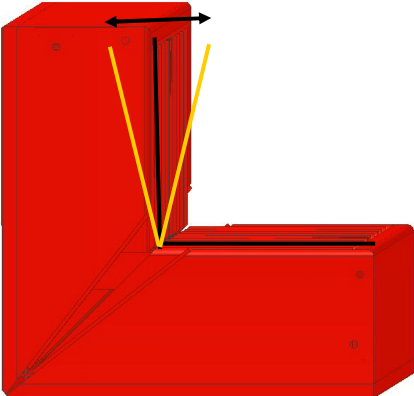

Sorszám	Név	Cikkszám
1	Sarok alátét	
2	Talplemez	
3	Kötőlemez	740205
4	Hossz profil	
5	Merevítő borda	
6	Átkötés, megvezető	721794

Vonatkozó termék	Cikk szám
Sarok elem TE 330-4	054374
Sarok elem TE 270-2	022580
Sarok elem 120-2	022660
Sarok elem 60-2	022840

Keret	Leírás	Javítás	Számlázás	típus
	27.32 Elem meghajlott	 		
	<ul style="list-style-type: none"> <li data-bbox="875 612 1075 638">■ > 3 mm ≤ 8 mm <li data-bbox="875 756 994 782">■ > 8 mm <p data-bbox="875 804 1279 831">Lásd 7. oldal 27.08 (mérés alu léccel)</p>			
	27.33 Sarok meghajlott			
	<ul style="list-style-type: none"> <li data-bbox="875 1074 1008 1099">■ > 10 mm 			

PERI Bérleti kritériumok

TRIO











TRIO falvastagság kiegyenlítő, acél

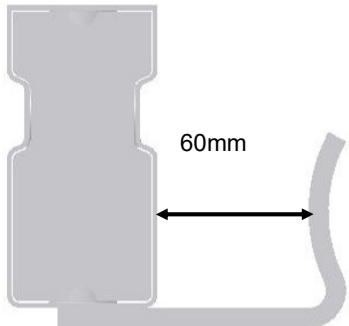



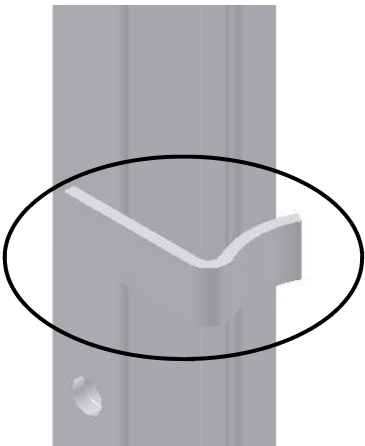



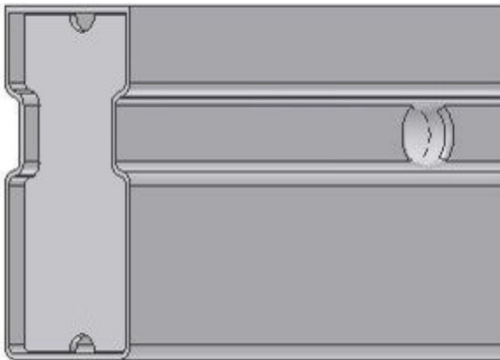

No.	Név	Cikkszám
1	Végzáró lemez	
2	Rögzítőprofil	
3	Zsaluzó felület	
4	Persely	

Vonatkozó termék	Cikkszám
TRIO falbetét WDA/4 330x6	054401
TRIO falbetét WDA/4 330x5	054391
TRIO falbetét WDA-2 270x6	023192
TRIO falbetét WDA-2 270x5	023182
TRIO falbetét WDA-2 120x6	023292
TRIO falbetét WDA-2 120x5	023282

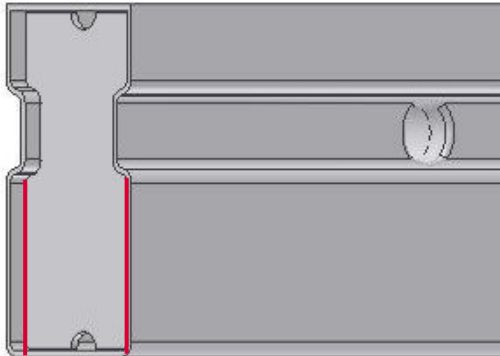
Profil	Leírás	Javítás	Számlázás	típus
	<p>27.34 Elem deformálódott, mérés alu léccel</p> <ul style="list-style-type: none"> ■ > 8 mm <p>Lásd 7. oldal 27.08 (mérés alu léccel)</p>			
	<p>27.35 Horpadás a zsaluzó felületen</p> <ul style="list-style-type: none"> ■ ≤ 3 mm ■ vagy > 3 mm-ig ≤ 10 mm ■ vagy > 10 mm 			
				
				

Rögzítő profil	Leírás	Javítás	Számlázás	típus
	27.36 Behorpadt vagy kihajlott a rögzítő profil	 		
	<ul style="list-style-type: none"> ■ ≤ 10 mm ■ vagy > 10 mm 			
	27.37 Rögzítő profil hiányzik			

Profil	Leírás	Javítás	Számlázás	típus
	27.38 Az alátét lemez eldeformálódott (de nincs sérülés a hegesztésnél)	 		
	27.39 Alátét lemez eldeformálódott (sérüléssel a hegesztésnél)			

PERI Bérleti kritériumok

TRIO



Végzáró elem MT

No.	Név	Cikkszám
-----	-----	----------

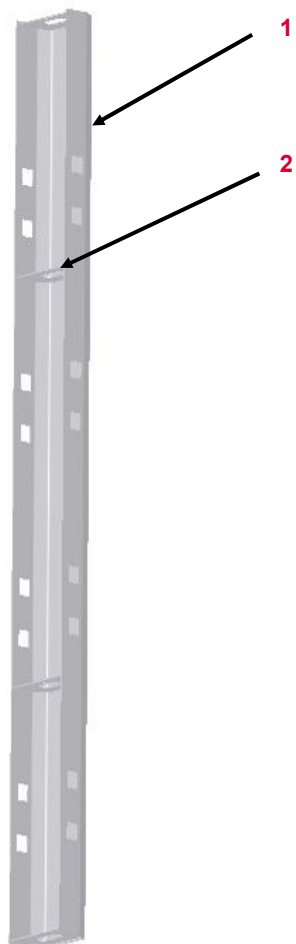

1	Profil
---	--------

2	Lemez
---	-------

Vonatkozó termék	Cikkszám
------------------	----------

Végzáró elem TRIO MT 270x35/36	023065
--------------------------------	--------

Végzáró elem TRIO MT 270x30	023064
-----------------------------	--------

Végzáró elem TRIO MT 270x24/25	023062
--------------------------------	--------

Végzáró elem TRIO MT 270x20	023061
-----------------------------	--------

Végzáró elem TRIO MT 120x35/36	023072
--------------------------------	--------

Végzáró elem TRIO MT 120x30	023071
-----------------------------	--------

Végzáró elem TRIO MT 120x24/25	023069
--------------------------------	--------

Végzáró elem TRIO MT 120x20	023068
-----------------------------	--------

Végző elem MT	Leírás	Javítás	Számlázás	típus
---------------	--------	---------	-----------	-------

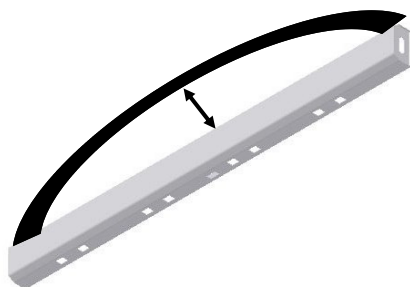

27.50 Elem elgörbült

- > 8 mm

Lásd 7. oldal 27.08 (mérés alu léccel)

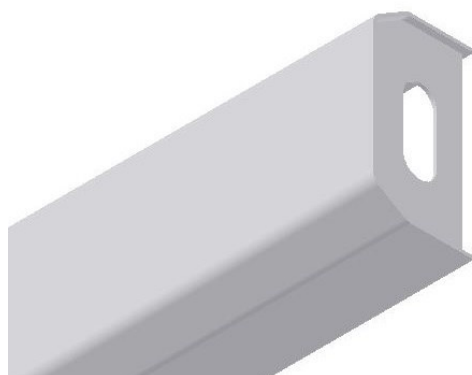

27.51 Lemez behorpadt

- Hegesztés nem sérült



088244



- Hegesztési sérüléssel



PERI Bérleti kritériumok

TRIO



Végzáró elem MTF

No.	Név	Cikkszám
-----	-----	----------

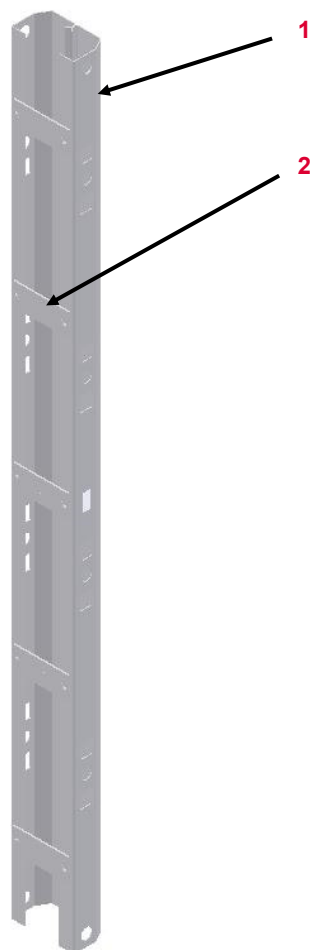

1	Profil
---	--------

2	Lemez
---	-------

Vonatkozó termék	Cikkszám
------------------	----------

Végzáró elem TRIO MTF 270x35/36	023076
---------------------------------	--------

Végzáró elem TRIO MTF 270x30	023077
------------------------------	--------

Végzáró elem TRIO MTF 270x24/25	023075
---------------------------------	--------



Végzáró elem TRIO MTF 270x20	023074
------------------------------	--------

Végzáró elem TRIO MTF 120x35/36	023079
---------------------------------	--------

Végzáró elem TRIO MTF 120x30	023078
------------------------------	--------

Végzáró elem TRIO MTF 120x24/25	023080
---------------------------------	--------

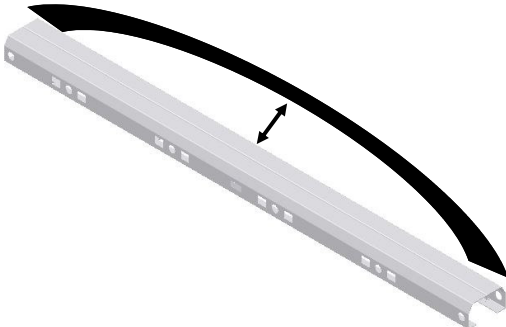













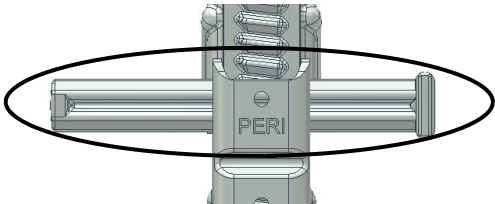

Végzáró elem TRIO MTF 120x20	023081
------------------------------	--------

Végzáró elem MTF	Leírás	Javítás	Számlázás	típus
	27.52 Profil elgörbült ■ > 8 mm Lásd 7. oldal 27.08 (mérés alu léccel)			
	27.53 Lemez hiányzik vagy eldeformálódott			

PERI Bérleti kritériumok

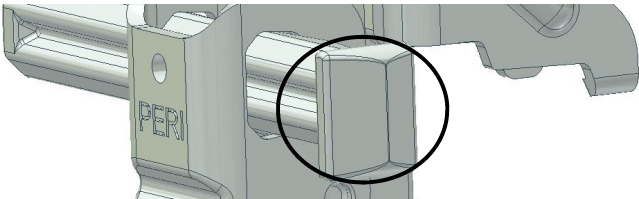
TRIO



BFD kapocs (023500)	Leírás	Javítás	Számlázás	típus
	27.70 Fogas elem görbült		 088032	
	27.71 A kapocs szétesett	 		
	27.72 A retesz elgörbült, elrepedt, nem mozgatható	 		
	27.73 Törés, vagy repedés az ütő felületen	 		

PERI Bérleti kritériumok

TRIO



TRIO betonozó konzol TRG

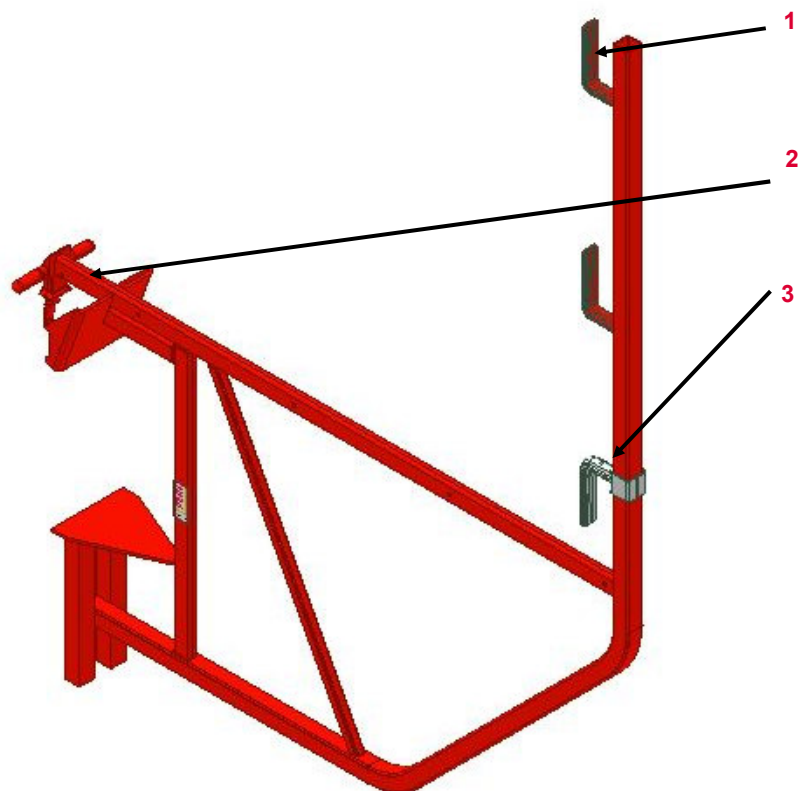

















No.	Név	Cikkszám
1	Korláttartó fül	(115543) kifutó
2	Betonozó konzol akasztó fej	
3	Lábdeszka rögzítő	115673

Vonatkozó termék	Cikkszám
Betonozó konzol TRG 120	(023680) kifutó
Betonozó konzol TRG 80	023670

PERI Bérleti kritériumok

TRIO













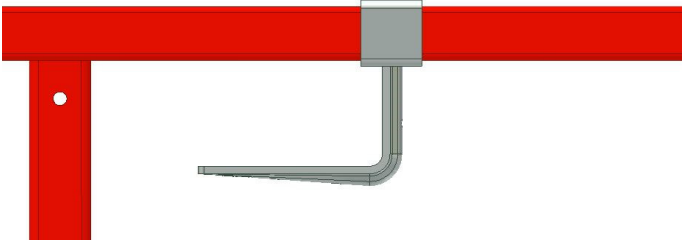

TRG betonozó konzol	Leírás	Javítás	Számlázás	típus
	<p>27.74 Az akasztó fej elgörbült</p> <ul style="list-style-type: none"> ■ az akasztófül talplemeze amely a TR bordáshoz kapcsolódik elgörbült, vagy nem beakasztható ■ akasztókampó a fejen elgörbült/eltört 	 		
	<p>27.75 A betonozó konzol törött, csonkult, repedt, elgörbült.</p>	 		
	<ul style="list-style-type: none"> ■ Görbülés mértéke > 5 mm 	 		
	<p>27.76 Horpadás a konzol szelvényén</p>	 		
	<ul style="list-style-type: none"> ■ Horpadás a kereten, de nem az élen ■ Horpadás a keret élén 	 		

PERI Bérleti kritériumok

TRIO



TRG betonozó konzol	Leírás	Javítás	Számlázás	típus
	27.77 Hegesztési varrat repedése			
	<ul style="list-style-type: none"> ■ Profil deformációval ■ Profil deformáció nélkül 	 		
	27.78 Lábdeszka rögzítő eldeformálódott, hiányzik	 115673	 088184	
	27.79 A konzol eldeformálódott, hiányzik	 	 088000	

PERI Bérleti kritériumok

TRIO





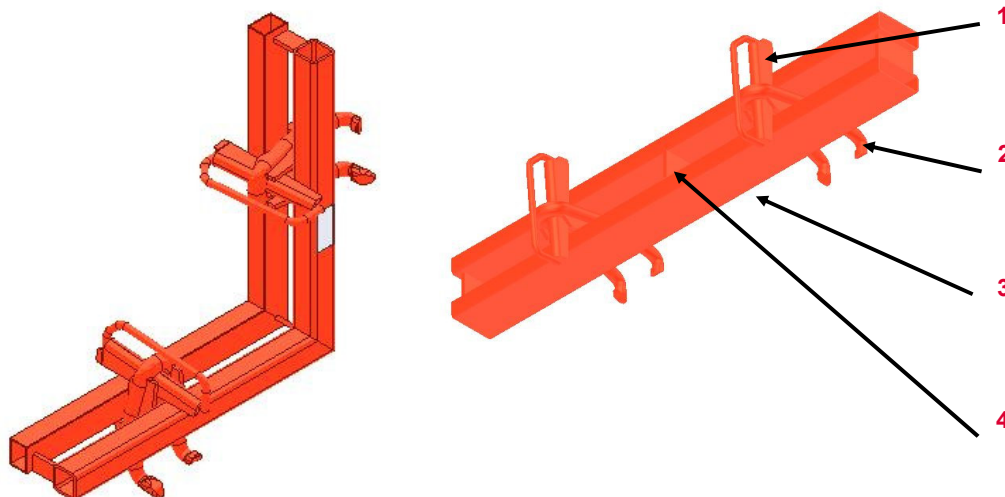









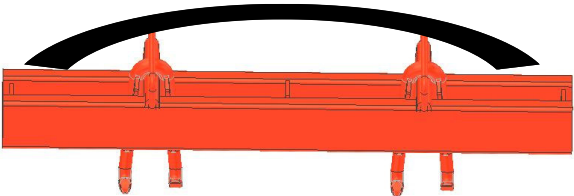

Hevederek	No.	Név	Cikkszám
-----------	-----	-----	----------

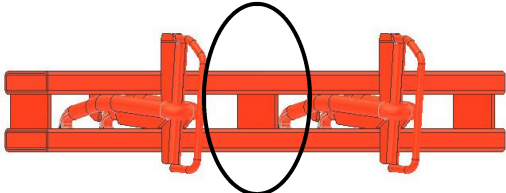

1	Heveder rögzítő ék	750585
2	Heveder rögzítő köröm	751543
3	Profil	
4	Távtartó	

Vonatkozó termék	Cikkszám
Kiegészítő heveder TAR 85	023550
Merevítő heveder TVR 45/45	023560



Heveder	Leírás	Javítás	Számlázás	típus
	<p>27.84 Heveder rögzítő köröm vagy ék sérült</p> <ul style="list-style-type: none"> ■ Hiány esetén pótlás 	 <p>751543 (TVR) 751544 (TAR) 750585 (mindkettőnél)</p>	 <p>088210 088209</p>	
	<p>27.85 Profil elgörbült</p> <ul style="list-style-type: none"> ■ > 5 mm-ig ≤ 10 mm ■ vagy > 10 mm 	 	 <p>088244</p> 	 
	<p>27.86 Távtartó hiányzik</p> <ul style="list-style-type: none"> ■ vagy deformálódott (görbület, nyomódás) 			

PERI Bérleti kritériumok

TRIO



TRIO támaszkapcsoló (023660)	Leírás	Javítás	Számlázás	típus
------------------------------	--------	---------	-----------	-------



27.90 Repedés a hegesztésnél



27.91 Sérült, elgörbült



088244



27.92 A háromszárnyú anya bütyke törött



030190 (háromszárnyú anya)













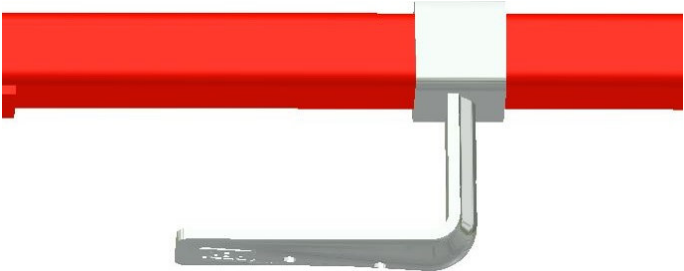



088541

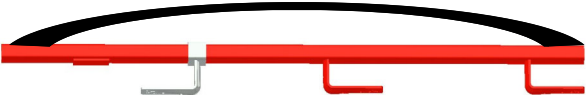

PERI Bérleti kritériumok

TRIO



















Betonozó korlát HSGP-2 (116292)	Leírás	Javítás	Számlázás	típus
	27.97 A lábdeszka rögzítő eldeformálódott, hiányzik	 Lábdeszka tartó (115673)	 088184	
	27.98 Konzol, eldeformálódott, eltört		 088000	
	27.99 Elgömbült, eldeformálódott <ul style="list-style-type: none"> ■ > 5 ≤ 10 mm ■ Ha > 10 mm 	 	 	 

PERI Bérleti kritériumok

Ikon magyarázatok



Ikon	Jelentés	Ikon	Jelentés	Ikon	Jelentés
	Nem OK — kicselezteendő		Ügyfélnek leszámházandó		Optikai kár
	OK– marad a bérleti parkban		Nincs számlázás		Funkcionális sérülés
	Selejt anyag – biztonsági okokból az anyagot tilos kiadni		Anyagot levágni		Funkcionális sérülés — anyag kiadása nem engedélyezett
	Javítás az előírások szerint		Anyagot megjelölni		Statikai sérülés — anyag kiadása nem engedélyezett
	Hideg egyengetés — utána a varratokat és a környékét ellenőrzni kell		Sérült anyag cseréje		
	Javítás gazdaságosság függvényében		Hiányzó anyag cseréje		
	Megtisztítani az anyagot				