

PERI Bérleti kritériumok

PERI UP Teherhordó állvány

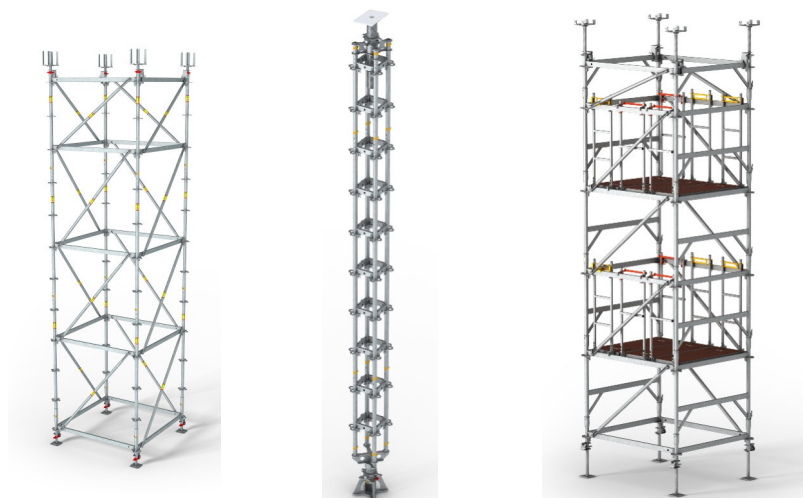

Kapcsolat

PERI kft,
zsaluzatok, állványzatok,
mérnöki szolgáltatás

H-1181 Budapest
Zádor u. 9.
Tel.: +36-1-296-09-60

Tartalom	oldal
PERI UP Flex Nagy teherbírású HD	2
PERI UP Flex Alátámasztó Torony MDS	12
PERI UP Flex Alátámasztó Torony	18
Áthelyező kerék UEW	24
Csatlakozó áthelyező kerékhez	26
Magyarázat	28

Változtatások	Dátum ü	oldal
Új Verzió	08/2021 Sz.L.	

PERI Bérleti kritériumok

PERI UP Teherhordó állvány



UP Csavaros Talp HD (126436)

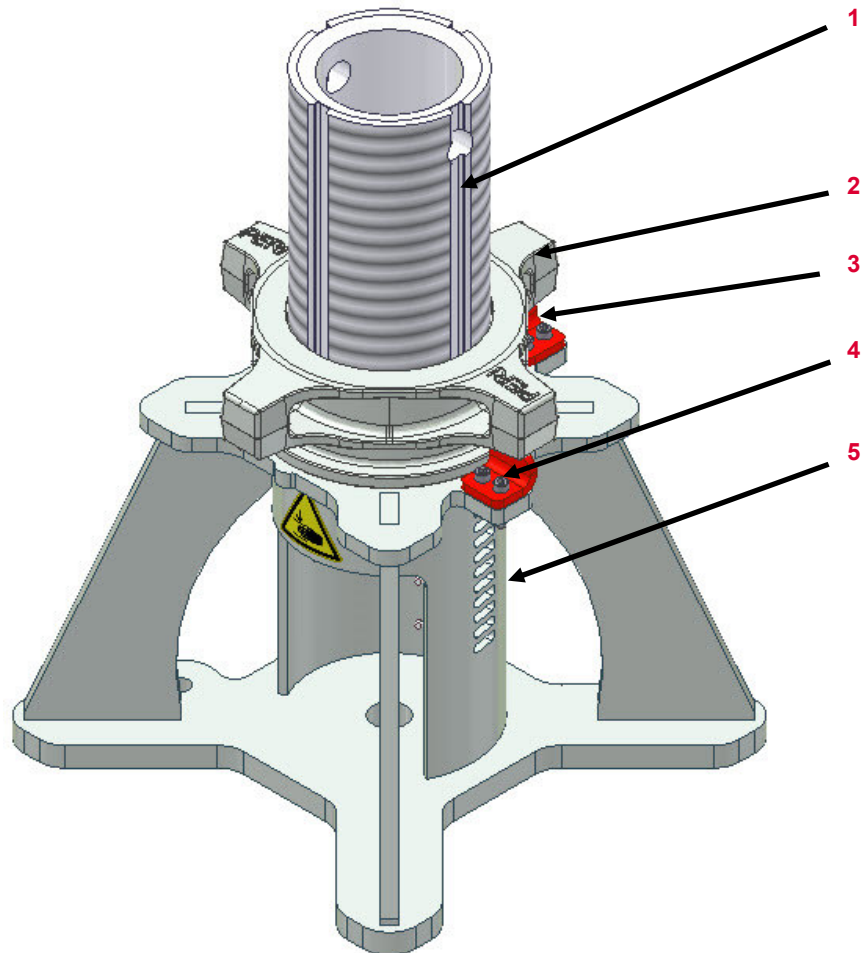











Sorszám	Megnevezés	Cikkszám
1	Orsós cső	127117
2	Szintező anya TR 110x9	780149
3	Ellentartó	127114
4	Csavar M5x25	127077
5	Láb a leeresztéshez	127123

PERI Bérleti kritériumok

PERI UP Teherhordó állvány











UP Csavaros Talp HD (126436)	Leírás	Instrukció	Fizetési kondíciók	Típus
	33.60.01 Szintező anya törött			
	33.60.02 Ellentartó			
	<ul style="list-style-type: none">■ Törött■ Vagy hiányzik	 	 	 

PERI Bérleti kritériumok

PERI UP Teherhordó állvány



UP Csavaros Talp HD (126436)	Leírás	Instrukció	Fizetési kondíciók	Típus
	33.60.03 Adattábla olvashatatlan			
	33.60.04 Menet sérült			

PERI Bérleti kritériumok

PERI UP Teherhordó állvány



UP Csavaros Fejtámasz TR 110-80/55 (126435)

Sorszám Megnevezés Cikkszám

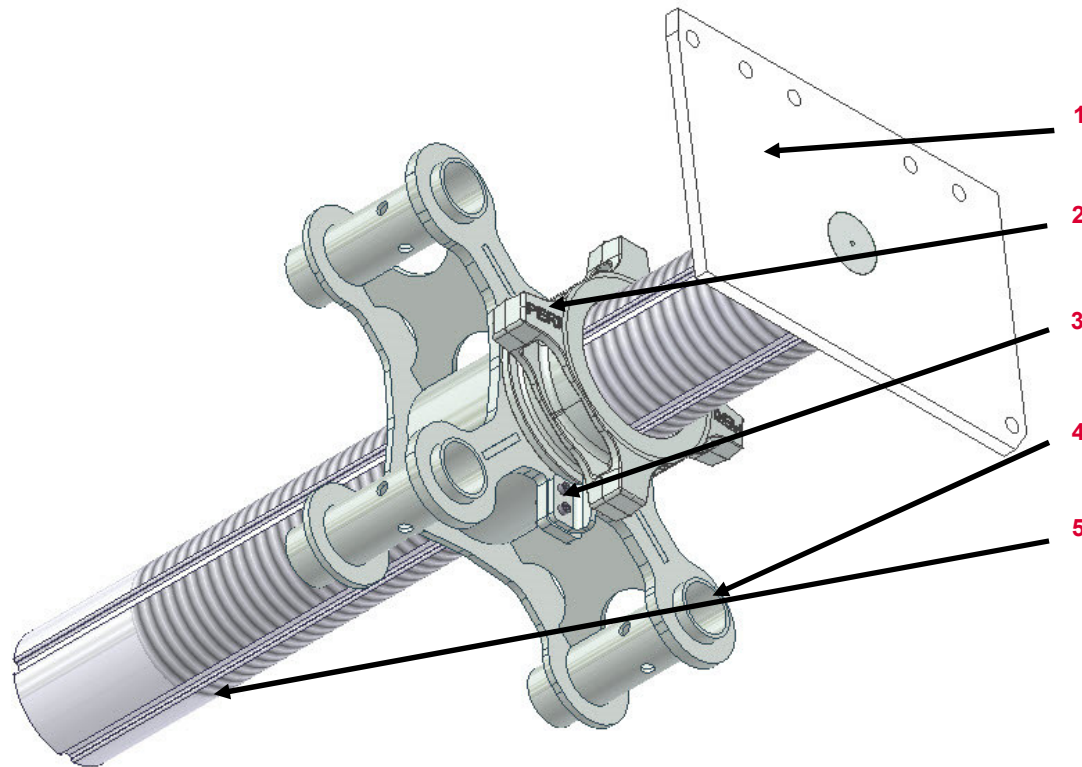







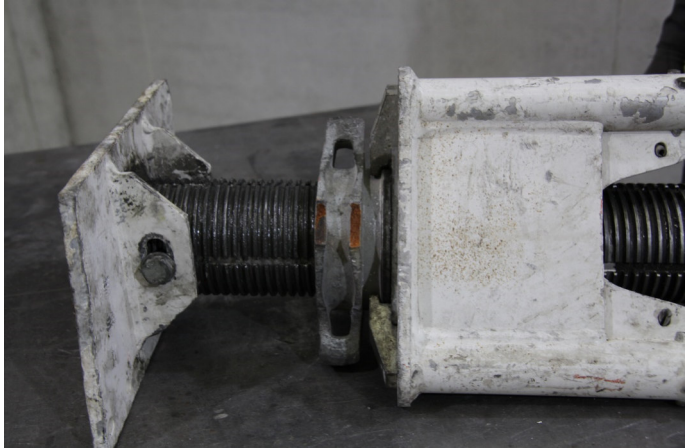

1	Oscilláló lemez	785263
2	Szintező anya TR 110x9	780149
3	Ellentartó	127101
4	Cső csatlakozása	127110
5	Orsós cső	127102

PERI Bérleti kritériumok

PERI UP Teherhordó állvány











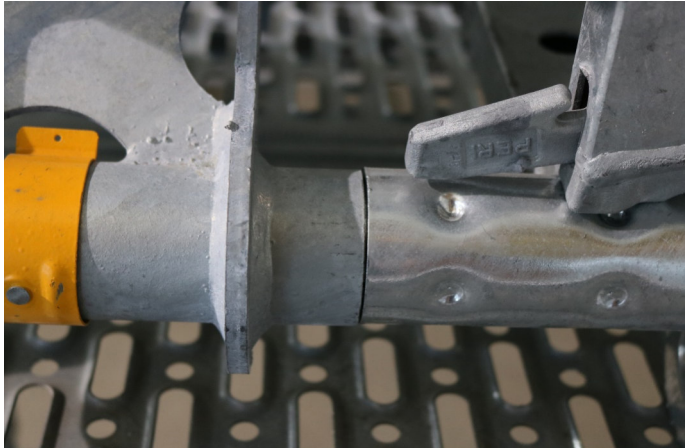





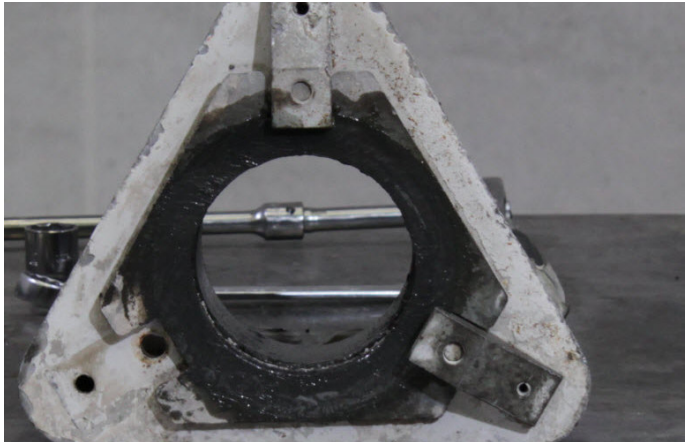

UP Csavaros Fejtámasz TR 110-80/55 (126435)	Leírás	Instrukció	Fizetési kondíciók	Típus
	33.60.05 Szintező anya törött			
	33.60.06 Oszcilláló lemez elhajlott			

PERI Bérleti kritériumok

PERI UP Teherhordó állvány



UP Csavaros Fejtámasz TR 110-80/55 (126435)	Leírás	Instrukció	Fizetési kondíciók	Típus
	<p>33.60.07 Cső csatlakozó elgörbült</p> <ul style="list-style-type: none"> ■ Ha lehetséges (cső behelyezhető) ■ Ha nem lehetséges ■ Vagy repedés a zinc rétegben 	<ul style="list-style-type: none">    	<ul style="list-style-type: none">    	<ul style="list-style-type: none">   
	<p>33.60.08 Tartó karom</p> <ul style="list-style-type: none"> ■ Törött ■ Vagy hiányzik 	<ul style="list-style-type: none">   	<ul style="list-style-type: none">   	<ul style="list-style-type: none">  

PERI Bérleti kritériumok

PERI UP Teherhordó állvány



UP Hidraulikai Egység HD (126438)

Sorszám Megnevezés Cikkszám

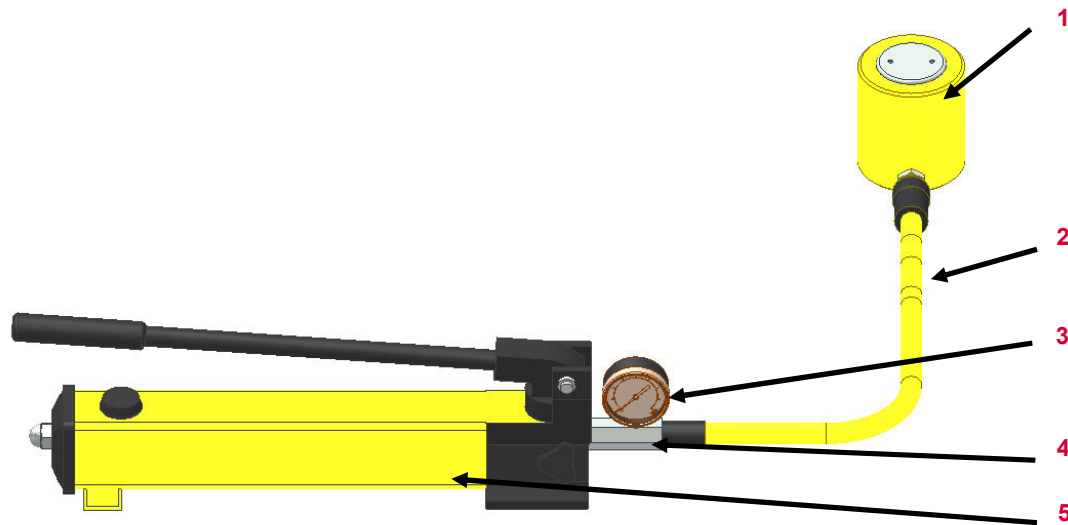















1	Henger	130792
2	Hidraulikus tömlő	130791
3	Nyomásmérő	130789
4	Nyomásmérő csatlakozó	130788
5	Kézi pumpa	130787

PERI Bérleti kritériumok

PERI UP Teherhordó állvány











UP Hidraulikai Egység HD (126438)	Leírás	Instrukció	Fizetési kondíciók	Típus
	<p>33.60.09 Henger nem funkcionál</p> <ul style="list-style-type: none"> ■ Kopás miatt ■ Vagy erőszak miatt 	<ul style="list-style-type: none">   	<ul style="list-style-type: none">   	<ul style="list-style-type: none">  
	<p>33.60.10 Tömlő</p> <ul style="list-style-type: none"> ■ Porózus ■ Vagy belevágtak 	<ul style="list-style-type: none">   	<ul style="list-style-type: none">   	<ul style="list-style-type: none">  

PERI Bérleti kritériumok

PERI UP Teherhordó állvány



UP Hidraulikai Egység HD (126438)	Leírás	Instrukció	Fizetési kondíciók	Típus
	33.60.11 Nyomásmérő nem funkcionál			
	33.60.12 Kézi pumpa nem funkcionál			

PERI Bérleti kritériumok

PERI UP Teherhordó állvány



UP HD Talp Csatlakozó UJC (126437)	Leírás	Instrukció	Fizetési kondíciók	Típus
------------------------------------	--------	------------	--------------------	-------

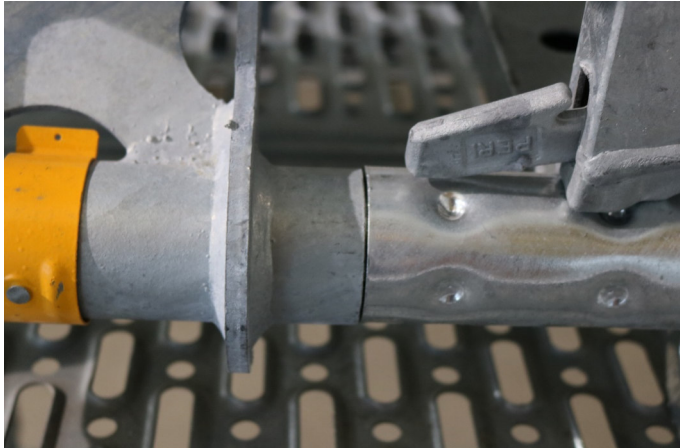

33.60.13 Csap görbült, horpadt

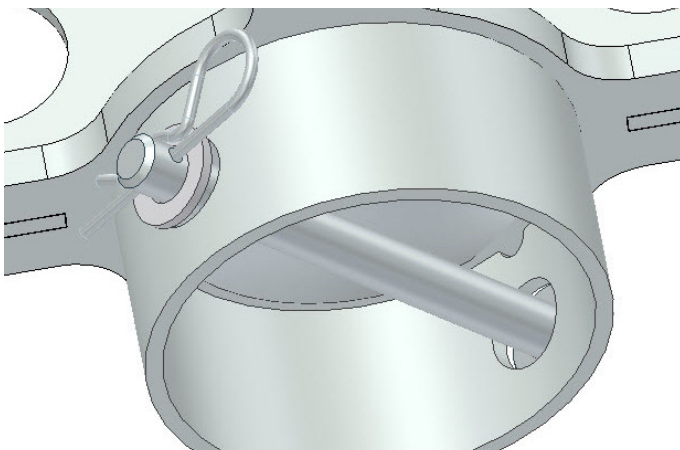

33.60.14 Csap / sasszeg

■ Hiányzik



127086 (Csap)
018060 (Sasszeg)
711074 (Alátét)



■ Vagy deformálódott



127086 (Csap)
018060 (Sasszeg)
711074 (Alátét)



PERI Bérleti kritériumok

PERI UP Teherhordó állvány



Alapkeret MDS

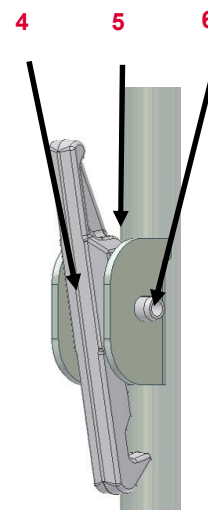
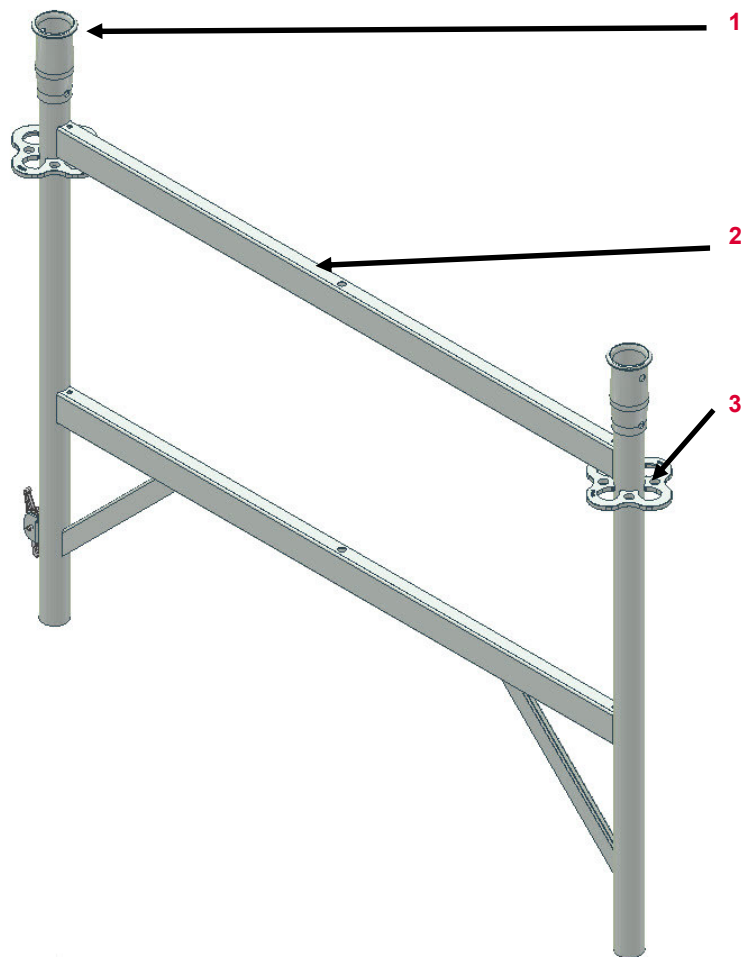























Sorszám	Megnevezés	Cikkszám
1	Csatlakozási pont	
2	Vízszintes szelvény	
3	Rozetta	
4	Biztosító kampó	710418
5	Nyomó rugó	710420
6	Hasított ék	724567

Megnevezés	Cikkszám
Alapkeret MDS 100	112012
Keret MDS 100	112052
Zárókeret MDS 50	112059
Közbenső keret MDS 50	112034

PERI Bérleti kritériumok

PERI UP Teherhordó állvány



Keret	Leírás	Instrukció	Fizetési kondíciók	Típus
	33.60.15 Csatlakozási pont Csap elgörbült			
	<ul style="list-style-type: none"> Behelyezés lehetséges 	 		
	<ul style="list-style-type: none"> Ha nem lehetséges 			
	<ul style="list-style-type: none"> Vagy a zinc réteg repedt 			
	33.60.16 Rozetta deformálódott			
	<ul style="list-style-type: none"> ≤ 20 mm 	 		
	<ul style="list-style-type: none"> Vagy > 20 mm 			
	<ul style="list-style-type: none"> Vagy repedés a rozettában / hegesztésben 			

PERI Bérleti kritériumok

PERI UP Teherhordó állvány



Keret	Leírás	Instrukció	Fizetési kondíciók	Típus
	33.60.17 Biztonsági kampó nem mozgatható			

PERI Bérleti kritériumok

PERI UP Teherhordó állvány



Szerelő Felület MDS 125 (125631)

Sorszám	Megnevezés	Cikkszám
---------	------------	----------

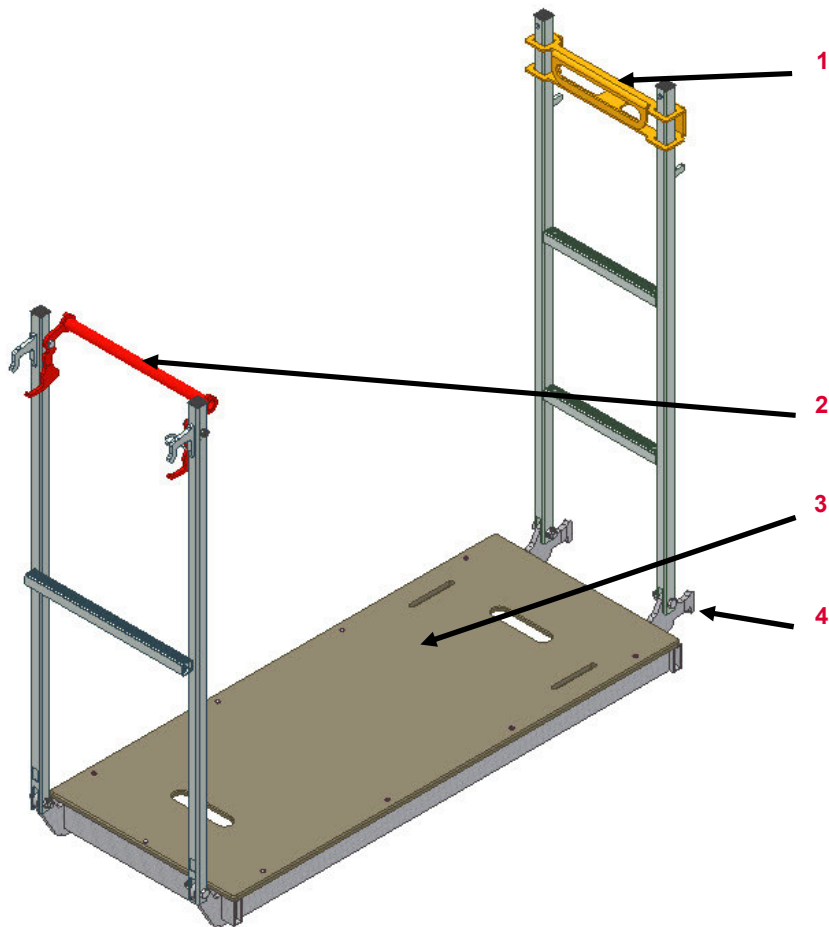



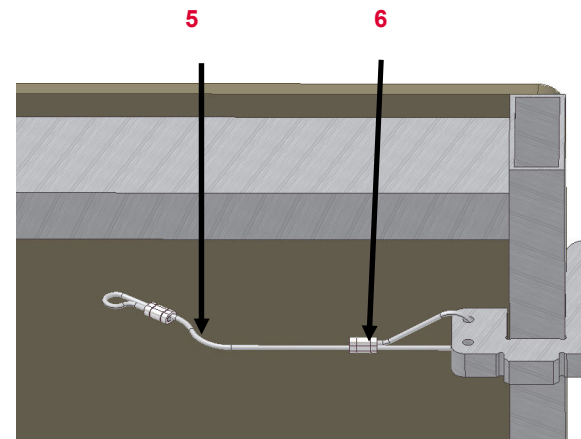



1	Zár	125653
2	Gravitációs kampó	125640
3	Fa járófelület MDS	125637
4	Csatlakozó konzol	
5	Sodrony kötél	127303
6	Szorító bilincs	127302



PERI Bérleti kritériumok

PERI UP Teherhordó állvány











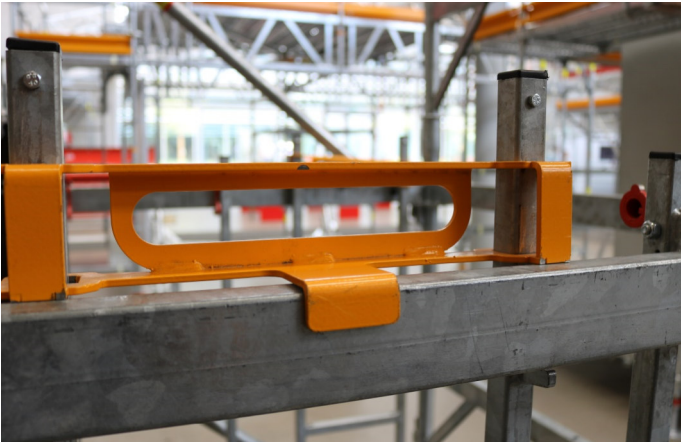

Szerelő Felület MDS 125 (125631)	Leírás	Instrukció	Fizetési kondíciók	Típus	
	33.60.18 Járó felület				
	<ul style="list-style-type: none"> ■ Kopott 				
	<ul style="list-style-type: none"> ■ Vagy használhatatlan (pl. törött) erőszak miatt 				
	33.60.19 Csatlakozó deformálódott				
	<ul style="list-style-type: none"> ■ Ha lehetséges 				
	<ul style="list-style-type: none"> ■ Ha nem lehetséges 		Alapkeret csere (125633)		
	<ul style="list-style-type: none"> ■ Vagy repedés a hegesztésben 		Alapkeret csere (125633)		

PERI Bérleti kritériumok

PERI UP Teherhordó állvány



Szerelő Felület MDS 125 (125631)	Leírás	Instrukció	Fizetési kondíciók	Típus
	33.60.20 Gravitációs kampó			
	<ul style="list-style-type: none"> ■ Deformálódott (nem funkcionál) ■ Vagy hiányzik 	 	 	 
	33.60.21 Zár			
	<ul style="list-style-type: none"> ■ Deformálódott (nem funkcionál) ■ Vagy hiányzik 	 	 	 

PERI Bérleti kritériumok

PERI UP Teherhordó állvány



Alaprúd És Rúdelem (117196; 117197)	Leírás	Instrukció	Fizetési kondíciók	Típus
-------------------------------------	--------	------------	--------------------	-------



33.60.22 Rozetta deformálódott

■ ≤ 20 mm



■ Vagy > 20 mm



■ Vagy repedés a rozettában



33.60.23 Teljes hosszon hajlott







■ > 3 mm (L/500)



PERI Bérleti kritériumok

PERI UP Teherhordó állvány



Alaprúd És Rúdelem (117196; 117197)	Leírás	Instrukció	Fizetési kondíciók	Típus
	33.60.24 Csatlakozási pont Csap elgörbült			
	<ul style="list-style-type: none">■ Egyengetés nem lehetséges			
	<ul style="list-style-type: none">■ Vagy repedés az anyagban			

PERI Bérleti kritériumok

PERI UP Teherhordó állvány



UP Állvány Merevítő UBS

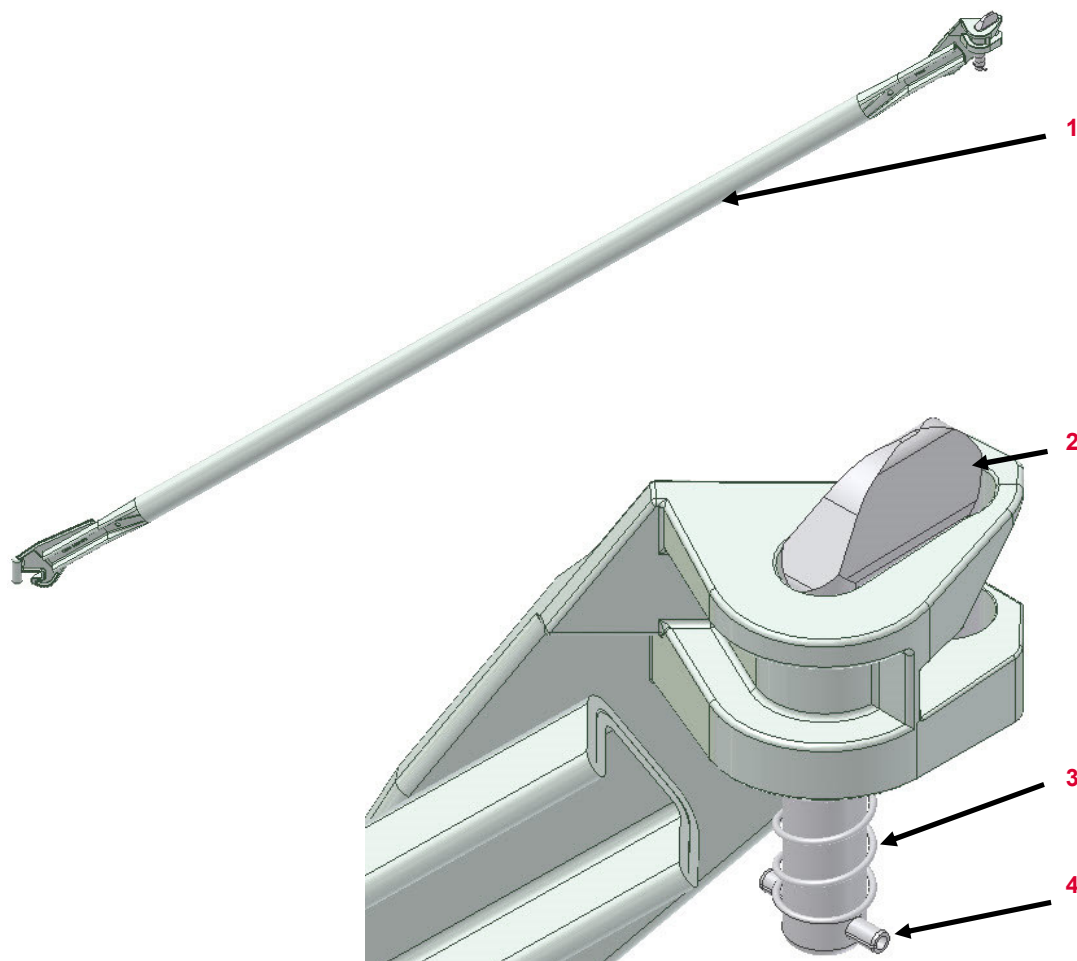











Sorszám	Megnevezés	Cikkszám
1	Merevítő	
2	csap UBK	100520
3	Nyomó rugú	722573
4	Hasított ék	710683

Megnevezés	Cikkszám
UP Állvány Merevítő UBS 100/100	128936
UP Állvány Merevítő UBS 150/100	107801
UP Állvány Merevítő UBS 200/100	115504
UP Állvány Merevítő UBS 250/100	123592
UP Állvány Merevítő UBS 300/100	123584
UP Állvány Merevítő UBS 100/150	129354
UP Állvány Merevítő UBS 150/150	107810
UP Állvány Merevítő UBS 200/150	115291
UP Állvány Merevítő UBS 250/150	123588
UP Állvány Merevítő UBS 300/150	123580

PERI Bérleti kritériumok

PERI UP Teherhordó állvány

















UP Állvány Merevítő UBS	Leírás	Instrukció	Fizetési kondíciók	Típus
	<p>33.60.25 Rugó nem működik</p>			
	<p>33.60.26 Csap</p> <ul style="list-style-type: none"> ■ Hiányzik ■ Vagy törött 	 	 	 

PERI Bérleti kritériumok

PERI UP Teherhordó állvány







UP Állvány Merevítő UBS	Leírás	Instrukció	Fizetési kondíciók	Típus
	33.60.27 Szegecs letört Kapcsoló hiányzik			
	33.60.28 Csap hajlott			
	<ul style="list-style-type: none"> ■ Ha lehetséges (csap behelyezhető) 			
	<ul style="list-style-type: none"> ■ Ha nem lehetséges 			
	<ul style="list-style-type: none"> ■ Vagy repedés az anyagban 			

PERI Bérleti kritériumok

PERI UP Teherhordó állvány





















Szintező anya zár UJS Plus (117743)	Leírás	Instrukció	Fizetési kondíciók	Típus
	33.60.29 Csap Hasított ék Sasszeg	 118383 (Csap) 780803 (Hasított ék) 722966 (Sasszeg)		
	<ul style="list-style-type: none"> ■ Hiányzik 			
	<ul style="list-style-type: none"> ■ Vagy erőszak miatt használhatatlan 	 118383 (Csap) 780803 (Hasított ék) 722966 (Sasszeg)		
	33.60.30 Biztosító lemez elgörbült			
	<ul style="list-style-type: none"> ■ Ha lehetséges (fukcióját ellátja) 			
	<ul style="list-style-type: none"> ■ Vagy már nem lehetséges 			

PERI Bérleti kritériumok

PERI UP Teherhordó állvány



UP Áthelyező Kerék UEW (116176)	Leírás	Instrukció	Fizetési kondíciók	Típus
	33.60.31 Fék deformálódott			
	<ul style="list-style-type: none"> ■ Még működik 	 		
	<ul style="list-style-type: none"> ■ Ha nem működik 			
<ul style="list-style-type: none"> ■ Vagy letört 				
	33.60.32 Kerék			
	<ul style="list-style-type: none"> ■ Elhasználódott 			
<ul style="list-style-type: none"> ■ Eltört vagy kitört darabok (futás nem egyenletes) 				

PERI Bérleti kritériumok

PERI UP Teherhordó állvány



UP Áthelyező Kerék orsóval UEW (116176)	Leírás	Instrukció	Fizetési kondíciók	Típus
---	--------	------------	--------------------	-------



33.60.33 Az orsó elgörbült

- Ha lehetséges



- Ha nem lehetséges



- Vagy repedés az anyagban



PERI Bérleti kritériumok

PERI UP Teherhordó állvány



UP Csatlakozó Áthelyező Kerékhez (116193; 130507)

Leírás

Instrukció

Fizetési kondíciók

Típus



33.60.34 Rugó nem funkcionál



116177 (Rugó)



33.60.35 Záró csap | Rugó | Alátét|
Hasított ék hiányzik



116181 (Csap)
116177 (Rugó)
711043 (Alátét)
721925 (Hasított ék)



PERI Bérleti kritériumok

PERI UP Teherhordó állvány



UP Csatlakozó Áthelyező Kerékhez (116193; 130507)	Leírás	Instrukció	Fizetési kondíciók	Típus
---	--------	------------	--------------------	-------



33.60.36 Csap elgörbült

- Ha lehetséges
- Ha nem lehetséges
- Vagy repedés az anyagban



33.60.37 Cső deformálódott

















- Szállítás lehetséges, beillesztve és rögzítve
- Vagy nem illeszthető



PERI Bérleti kritériumok

Magyarázat



Ikon	Jelentése	Ikon	Jelentése	Ikon	Jelentése
	Nem Ok– Selejtezendő		Ügyfélnek számlázandó		Optikai kár
	OK– marad a bérleti parkban		Nincs számlázás		Funkcionális sérülés
	Selejt anyag– biztonsági okokból az anyagot tilos kiadni		Anyagot levágni		Funkcionális sérülés— anyag kiadása nem engedélyezett
	Javítás az előírások szerint		Anyagot megjelölni		Statikai sérülés— anyag kiadása nem engedélyezett
	Hideg egyengetés– utána a varratokat és a környékét ellenőrizni kell		Sérült anyag cseréje		
	Javítás gazdaságosság függvényében		Hiányzó anyag pótlása		
	Megtisztítani az anyagot				