

PERI Bérleti kritériumok

HD 200 Nehézállvány

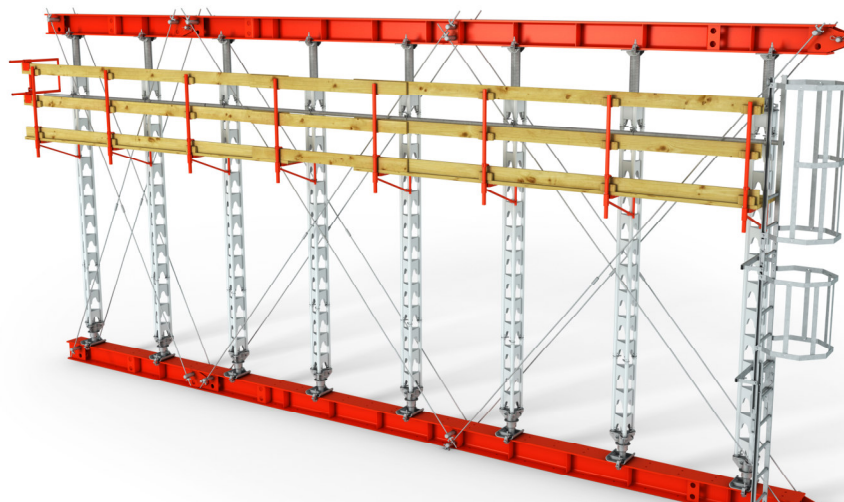

Kapcsolat

PERI kft,
zsárluzatok, állványzatok,
mérnöki szolgáltatás

H-1181 Budapest
Zádor u. 9.
Tel.: +36-1-296-09-60
www.peri.hu

Tartalom	oldal	Változás	Dátum ü	oldal
Támaszelem	2	Új verzió	07/2021 O.L.	
Csavaros talp	5			
Csavaros fejtámasz	8			
Láb adapter	13			
Főtartó	15			
Támaszfej	17			
Talp	19			
Korlátkonzol	20			
Faltámasz Kapcsoló	22			

PERI Bérleti kritériumok

HD 200 Nehézállvány



Támaszelem HDS / HDSS

Sorsz. Megnevezés Cikkszám

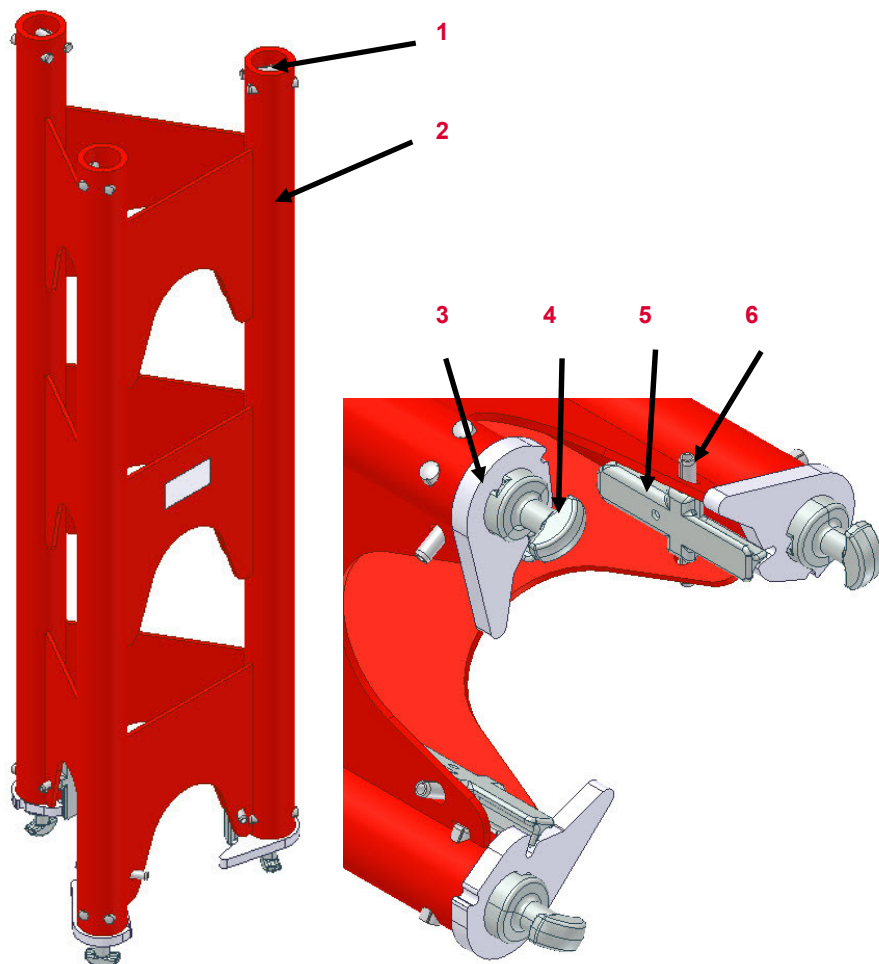

1	Csap	780150
2	Támaszelem	
3	Fogantyú lemez	780151
4	Övcsatlakozó	780143
5	Biztonsági retesz	780144
6	Hasított ék	770013

Megnevezés

















Cikkszám

Támaszelem HDS 30 Alu	022006
Támaszelem HDS 90 Alu	022005
Támaszelem HDS 270 Alu	022004
Támaszelem HDSS 90 Acél	111276
Támaszelem HDSS 210 Acél	103993
Csatlakozó elem HD 30	022020

PERI Bérleti kritériumok

HD 200 Nehézállvány



Támaszelem	Leírás	Instrukció	Fizetési kondíció	Típus
	04.10.01 Övcsatlakozó Retesz			
	<ul style="list-style-type: none"> ■ Hiányzik 			
	<ul style="list-style-type: none"> ■ Deformálódott 			
	<ul style="list-style-type: none"> ■ Vagy Eltört 			
	04.10.02 Cső vagy összekötő			
	<ul style="list-style-type: none"> ■ Deformálódott 			
	<ul style="list-style-type: none"> ■ Vagy belevágtak 			

PERI Bérleti kritériumok

HD 200 Nehézállvány



Támaszelem	Leírás	Instrukció	Fizetési kondíció	Típus
	04.10.03 Csap Hasított ék			
	■ Hiányzik			
	■ Vagy erőhatás miatt sérült			

PERI Bérleti kritériumok

HD 200 Nehézállvány



Csavaros Talp HDA (022003)	Leírás	Instrukció	Fizetési kondíció	Típus
----------------------------	--------	------------	-------------------	-------



04.10.04 Állítócsavar hiányzik



722569 (Állítócsavar)
022018 (Biztosító dugasz)



04.10.05 Szétesett



Szakképzett személy javíthatja



PERI Bérleti kritériumok

HD 200 Nehézállvány



Csavaros Talp HDA (022003)	Leírás	Instrukció	Fizetési kondíció	Típus
----------------------------	--------	------------	-------------------	-------



04.10.06 Deformálódott

- Ha kismértékű a deformitás és javítható



04.10.07 Típus tábla

- Hiányzik
- Vagy nem olvasható



PERI Bérleti kritériumok

HD 200 Nehézállvány



Csavaros Talp HDA (022003)	Leírás	Instrukció	Fizetési kondíció	Típus
----------------------------	--------	------------	-------------------	-------



04.10.08 Repedés a hegesztésben

- Deformációkkal (horpadások)
- Vagy deformációk nélkül



04.10.09 Erősen szennyezett

- Funkcionálisan működik
- Vagy funkcionálisan nem működik



PERI Bérleti kritériumok

HD 200 Nehézállvány



Csavaros lejtámasz HDK 45 (022007) | Támasz lábcsavar (022023)

Sorsz. Megnevezés Cikkszám

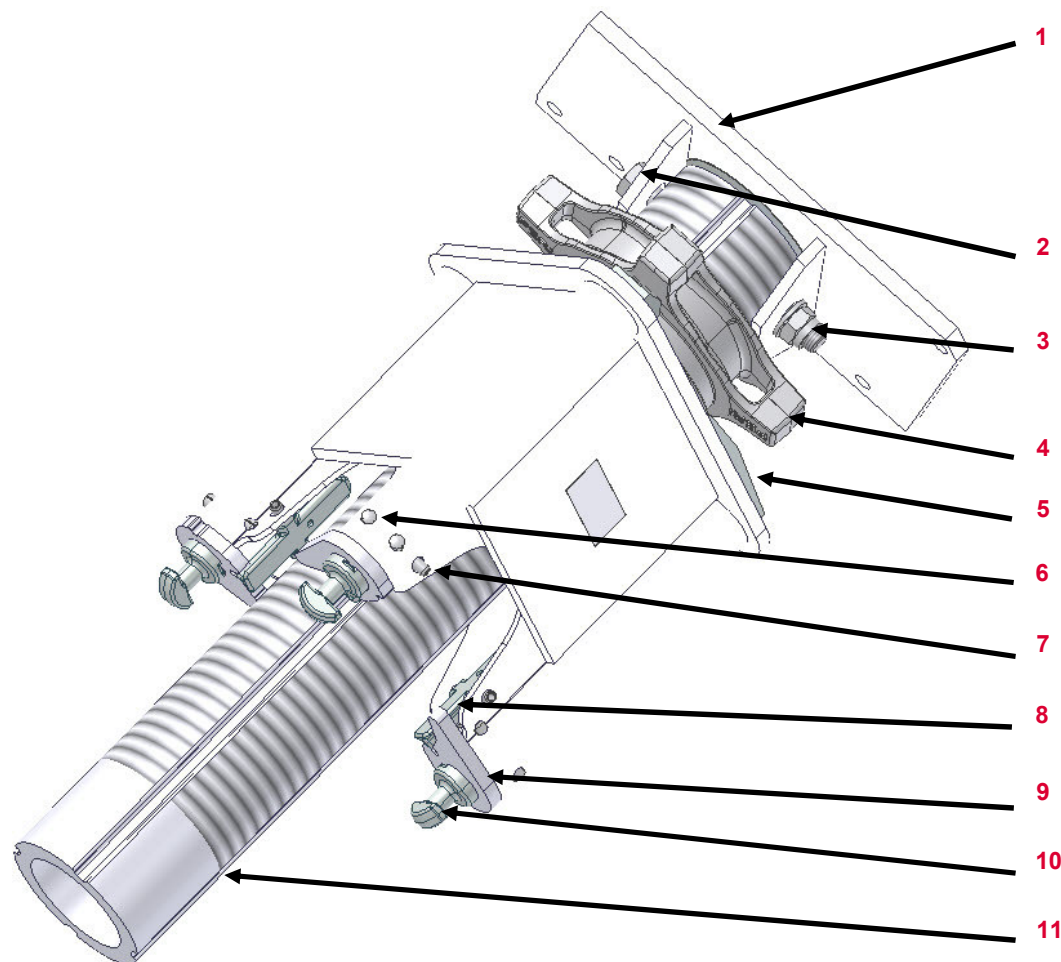









1	Inga lemez	785263
2	Csavar M 16 x 160	780155
3	Anya M 16	070890
4	Szintező anya	780149
5	Rögzítő karom	780157
6	Csap	780150
7	Hasított ék	780800
8	Biztonsági retesz	780144
9	Fogantyú lemez	780151
10	Övcsatlakozó	780143
11	Menetes cső	770210

PERI Bérleti kritériumok

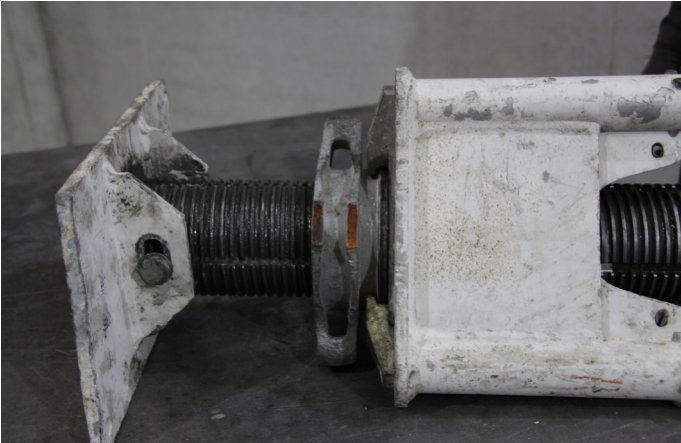
HD 200 Nehézállvány



Csavaros fejtámasz /Támasz lábcsavar	Leírás	Instrukció	Fizetési kondíció	Típus
	04.10.10 Inga lemez deformálódott			
	04.10.11 Szintező anya törött			

PERI Bérleti kritériumok

HD 200 Nehézállvány



Csavaros fejtámasz Támasz lábcsavar	Leírás	Instrukció	Fizetési kondíció	Típus
---------------------------------------	--------	------------	-------------------	-------



04.10.12 Rögzítő karom hiányzik

















04.10.13 Cső | Menet sérült,
Funkcionálisan nem működik



PERI Bérleti kritériumok

HD 200 Nehézállvány













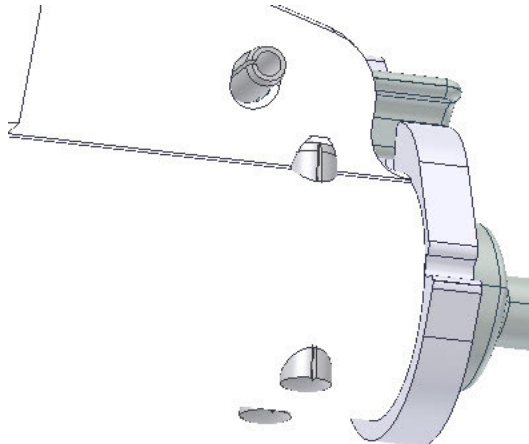

Csavaros fejtámasz HDK 45	Leírás	Instrukció	Fizetési kondíció	Típus
	04.10.14 Övcsatlakozó			
	<ul style="list-style-type: none"> ■ Hiányzik 			
	04.10.15 Fogantyú lemez			
	<ul style="list-style-type: none"> ■ Hiányzik 			
	<ul style="list-style-type: none"> ■ Vagy erőhatás miatt sérült 			
	<ul style="list-style-type: none"> ■ Vagy erő miatt sérült 			

PERI Bérleti kritériumok

HD 200 Nehézállvány











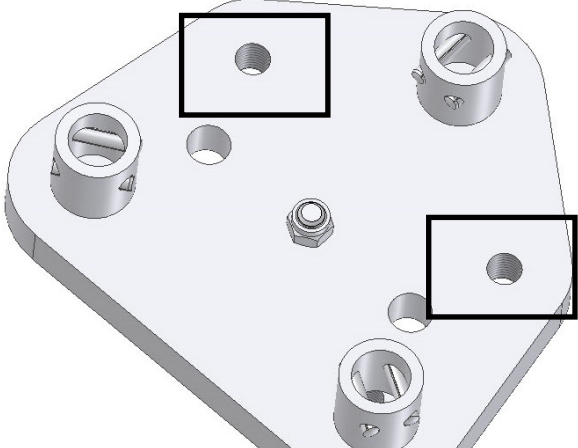

Csavaros fejtámasz HDK 45	Leírás	Instrukció	Fizetési kondíció	Típus
	04.10.16 Biztonsági retesz			
	<ul style="list-style-type: none"> ■ Hiányzik 			
	<ul style="list-style-type: none"> ■ Vagy erőhatás miatt sérült 			
	04.10.17 Csap Hasított ék			
	<ul style="list-style-type: none"> ■ Hiányzik 			
	<ul style="list-style-type: none"> ■ Vagy erő miatt sérült 			

PERI Bérleti kritériumok

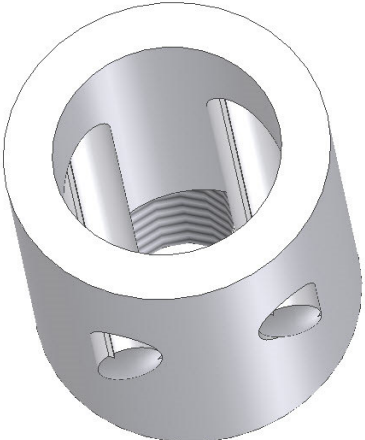
HD 200 Nehézállvány



Láb adapter HD (022019)	Leírás	Instrukció	Fizetési kondíció	Típus
	04.10.18 Menetek sérültek			
	Ha lehetséges	 Menet újravágása		
	■ Vagy ha nem lehetséges többé			
	04.10.19 Csap Hiányzik	 780150 (Csap)		

PERI Bérleti kritériumok

HD 200 Nehézállvány



Láb adapter HD (022019)	Leírás	Instrukció	Fizetési kondíció	Típus
-------------------------	--------	------------	-------------------	-------

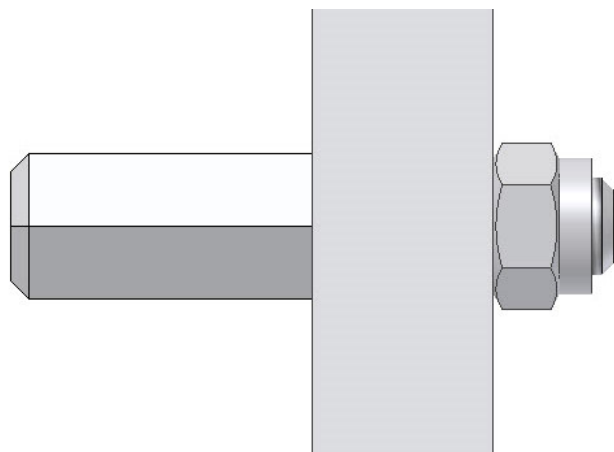

04.10.20 Centírozó csavar| Anya
Hiányzik



710352 (Centírozó csavar)
070890 (anya)



PERI Bérleti kritériumok

HD 200 Nehézállvány



Főtartó HDT (022008 022009 022010)	Leírás	Instrukció	Fizetési kondíció	Típus
--	--------	------------	-------------------	-------



04.10.21 Csap | Sasszeg | Hasított ék hiányzik



105435 (Csap)
710618 (Sasszeg)
722457 (Hasított ék)

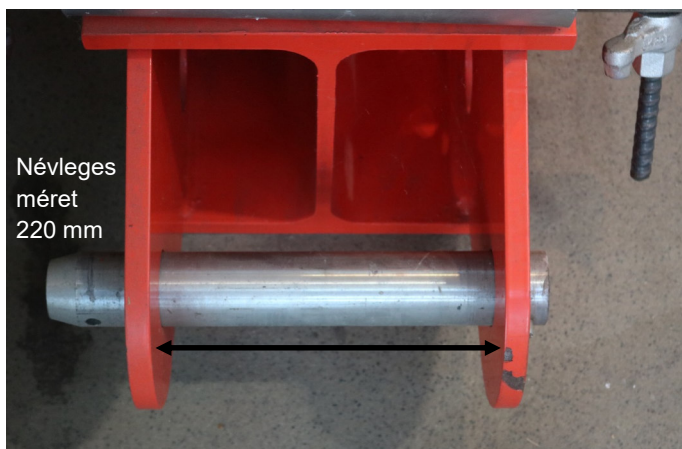

04.10.22 Csatlakozási lemezek deformálódtak



PERI Bérleti kritériumok

HD 200 Nehézállvány



Főtartó HDT (022008 022009 022010)	Leírás	Instrukció	Fizetési kondíció	Típus
--	--------	------------	-------------------	-------



04.10.23 Vágás a gerendán

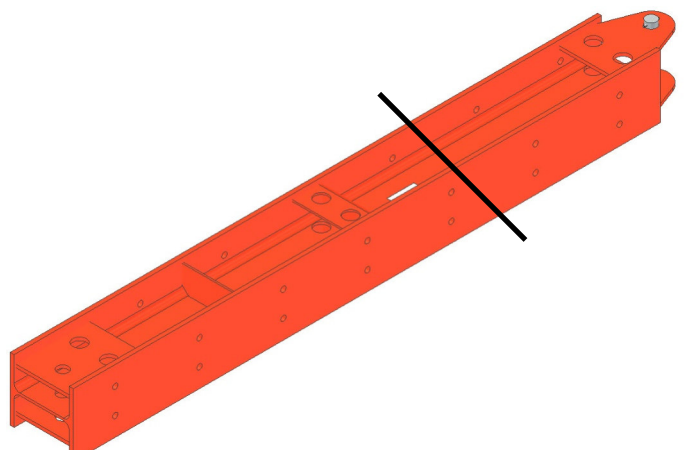















04.10.24 Gerenda rövidítése



PERI Bérleti kritériumok

HD 200 Nehézállvány









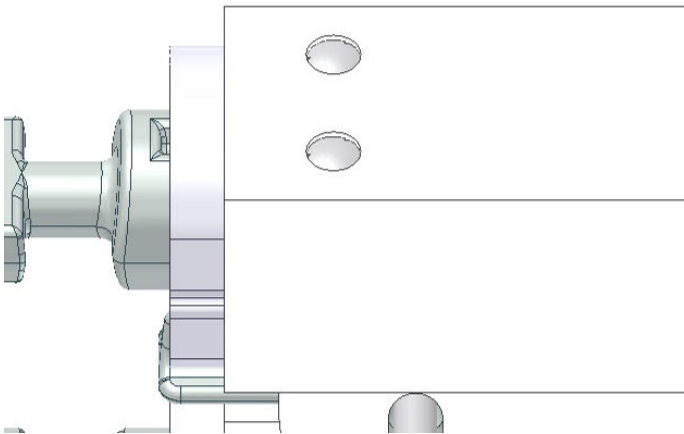

Támaszfej HD (022022)	Leírás	Instrukció	Fizetési kondíció	Típus
	04.10.25 Fogantyú lemez Övcsatlakozó <ul style="list-style-type: none"> ■ Hiányzik 	 780143 (Övcsatlakozó) 780151 (Fogantyú lemez)		
	<ul style="list-style-type: none"> ■ Vagy erőhatás miatt sérült 	 780143 (Övcsatlakozó) 780151 (Fogantyú lemez)		
	04.10.26 Biztonsági retesz Csap <ul style="list-style-type: none"> ■ Hiányzik 	 780144 (Biztonsági retesz) 770013 (Csap)		
	<ul style="list-style-type: none"> ■ Vagy erőhatás miatt sérült 	 780144 (Biztonsági retesz) 770013 (Csap)		

PERI Bérleti kritériumok

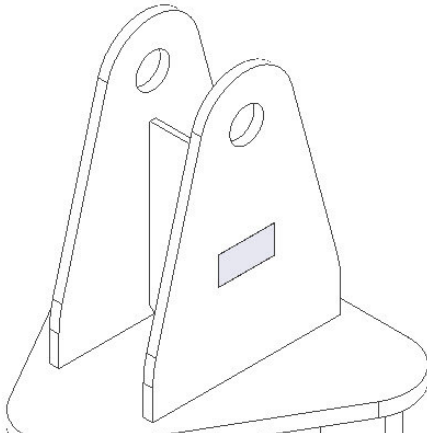
HD 200 Nehézállvány



Támaszfej HD (022022)	Leírás	Instrukció	Fizetési kondíció	Típus
	04.10.27 Csap hiányzik	 780150 (Csap)		
	04.10.28 Lemezek hajlottak			

PERI Bérleti kritériumok

HD 200 Nehézállvány



Talp HD (022024)	Leírás	Instrukció	Fizetési kondíció	Típus
------------------	--------	------------	-------------------	-------

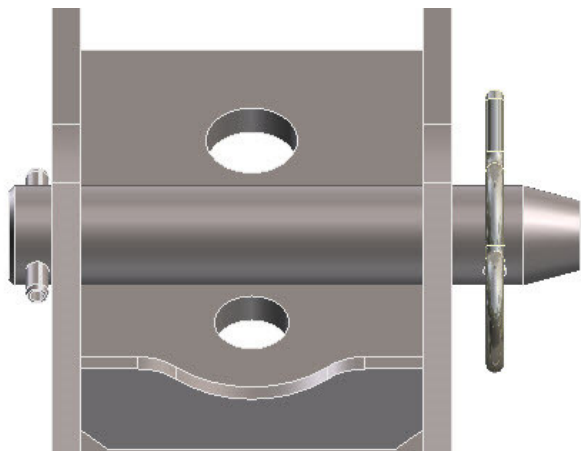

04.10.29 Csap | Hüvely | Saszeg hiányzik



722465 (Csap)
710304 (Saszeg)
770012 (Hüvely)

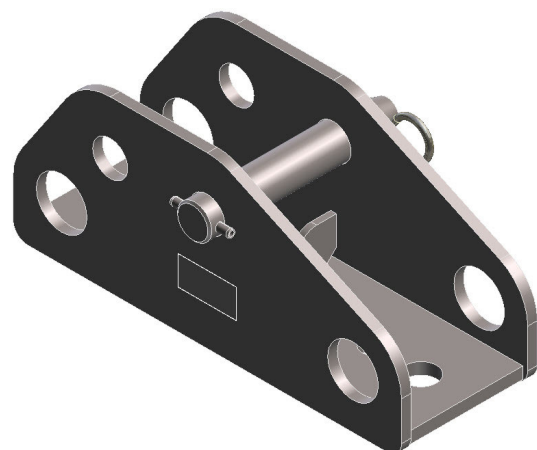

04.10.30 Deformálódott



PERI Bérleti kritériumok

HD 200 Nehézállvány



Korlátkonzol HD 75 (022017)	Leírás	Instrukció	Fizetési kondíció	Típus
-----------------------------	--------	------------	-------------------	-------



04.10.31 Kalapácsfejű csavar | anya hiányzik



131316 (Kalapácsfejű csavar)
710340 (Anya)

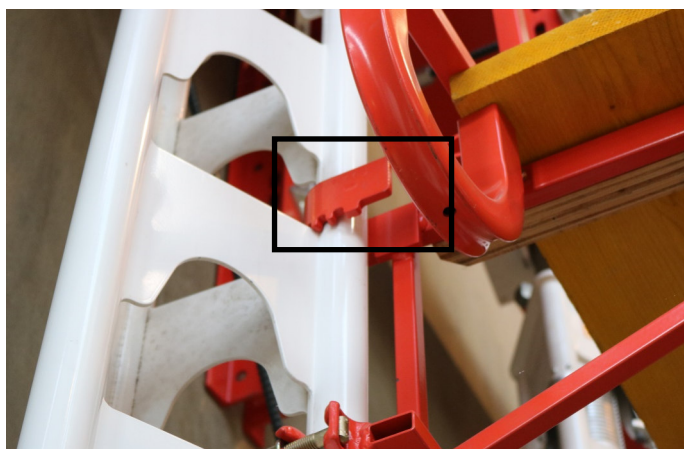

04.10.Csatlakozó deformálódott

- Ha lehetséges
- Ha nem lehetséges
- Vagy törés/repedés van az anyagban/hegesztésben



PERI Bérleti kritériumok

HD 200 Nehézállvány



Korlátkonzol HD 75 (022017)	Leírás	Instrukció	Fizetési kondíció	Típus
-----------------------------	--------	------------	-------------------	-------

04.10.33 Rögzítő lécs sérült



715044 (Rögzítő lécs)

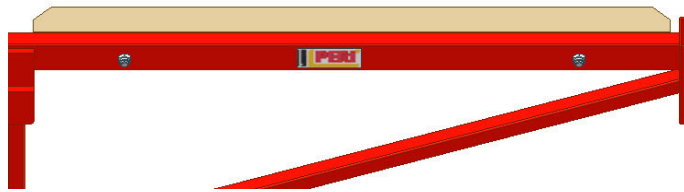

PERI Bérleti kritériumok

HD 200 Nehézállvány



Falt. Kapcsoló HDR HDR-2 (022016 131723)	Leírás	Instrukció	Fizetési kondíció	Típus
--	--------	------------	-------------------	-------



04.10.34 Kalapácsfejű csavar | Anya hiányzik



131316 (Kalapácsfejű csavar)
710340 (Anya)



04.10.35 Csap | Sasszeg hiányzik











027170 (Csap)
018060 (Sasszeg)



PERI Bérleti kritériumok

HD 200 Nehézállvány



















Falt. Kapcsoló HDR HDR-2 (022016 131723)	Leírás	Instrukció	Fizetési kondíció	Típus
	04.10.36 Csatlakozó deformálódott			
	<ul style="list-style-type: none">■ Ha lehetséges			
	<ul style="list-style-type: none">■ Ha nem lehetséges	 		

PERI Bérleti kritériumok

Magyarázat



Ikon	Jelentés	Ikon	Jelentés	Ikon	Jelentés
	Nem OK — kicselezendő		Ügyfélnek leszámházandó		Optikai kár
	OK– marad a bérleti parkban		Nincs számlázás		Funkcionális sérülés
	Selejt anyag – biztonsági okokból az anyagot tilos kiadni		Anyagot levágni		Funkcionális sérülés — anyag kiadása nem engedélyezett
	Javítás az előírások szerint		Anyagot megjelölni		Statikai sérülés — anyag kiadása nem engedélyezett
	Hideg egyengetés — utána a varratokat és a környékét ellenőrzni kell		Sérült anyag cseréje		
	Javítás gazdaságosság függvényében		Hiányzó anyag pótlása		
	Megtisztítani az anyagot				