

# PERI bérleti kritériumok

## ST 100 máglyatorony-állvány

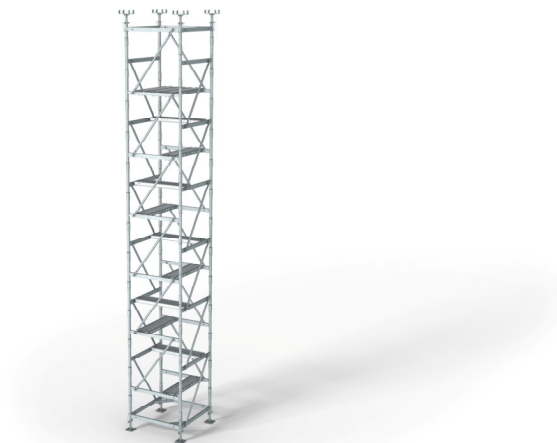

### Kapcsolat

**PERI Kft**  
**Zsaluzatok, állványzatok,**  
**mérnöki szolgáltatás**

H-1181 Budapest Zádor utca 9.  
Tel.: +36-1-296-0960  
[www.peri.hu](http://www.peri.hu)

Tartalom	Page	Változások	Date   Initial	Page
alap-, máglya-, zárókeret	2	új verzió	03/2016   fw	
átlós merevítő	4	képek cseréi	05/2018   fw	
keresztfejes fejtámasz	5	fordítás	09/2021 / V2A	
csavaros talp	7			
csavaros fejtámasz	8			
heveder	9			
áthelyező kerék UEW	15			
áthelyező kerék csatlakozó	16			
ikonok	18			

# PERI bérleti kritériumok

## ST 100 máglyatorony-állvány



### alapteret, máglyakeret, zárókeret

sorsz.

név

cikkszám

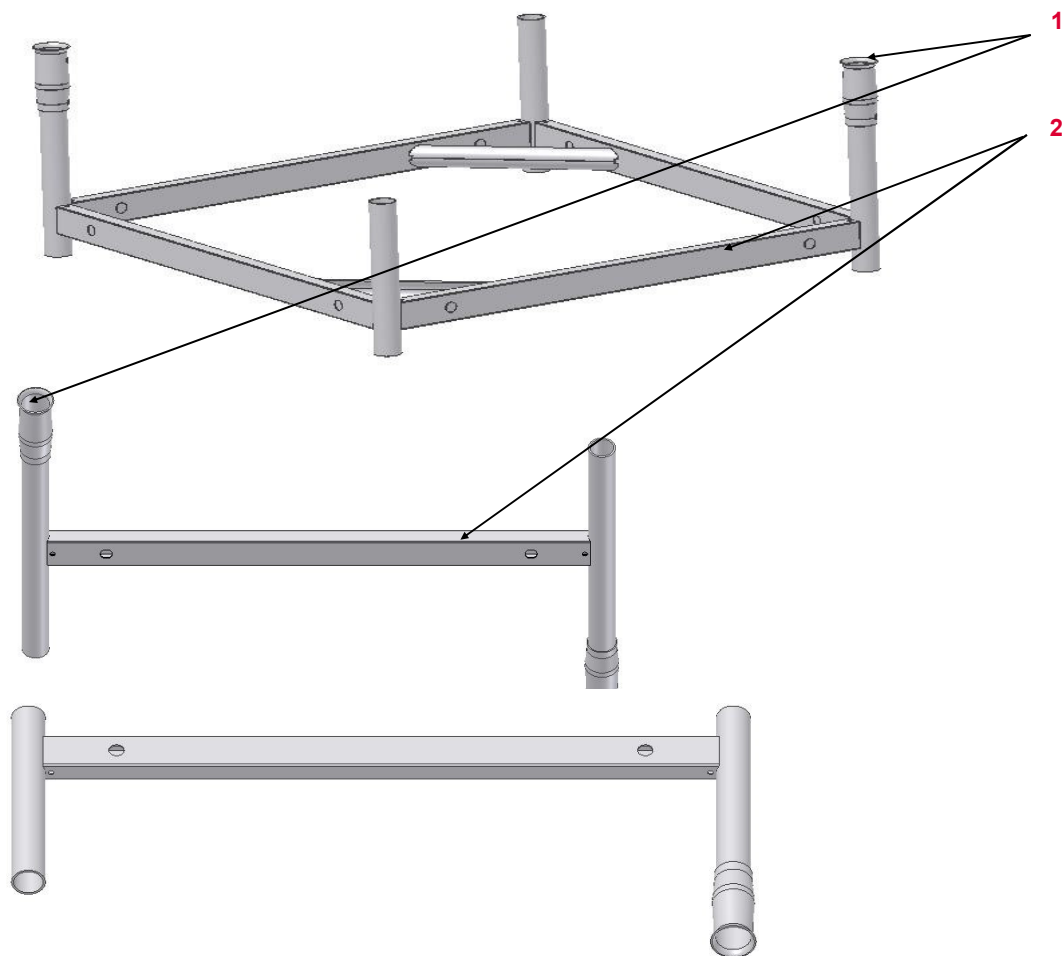

1

cső

2

keret (Az UH szerepét az ST100  
esetében a keret tölti be ezért  
arra az UH mindenkori kritériumai  
a mérvadóak!)

érvényes

cikkszám

alapteret ST 100 horganyzott

019900

máglyakeret horganyzott 100 horganyzott

019910

























zárókeret ST 100 horganyzott

019930

# PERI bérleti kritériumok

## ST 100 máglyatorony-állvány





















cső, keret	leírás	teendő	fizetési kondíció	típus
	<b>16.01 kereten lyukak, vagy görbület</b> <ul style="list-style-type: none"> <li>■ <math>D \leq 10</math> mm</li> <li>■ Vagy <math>d &gt; 10</math> mm</li> <li>■ amennyiben a profil éle érintett</li> </ul>	   	  	  
	<b>16.02 csővég elhajlott</b> <ul style="list-style-type: none"> <li>■ <math>\leq 10</math> mm</li> <li>■ vagy <math>&gt; 10</math> mm</li> <li>■ Fontos: egy másik kerettel történő összeillesztése nem lehetséges</li> </ul>	 	 088244 	 
	<b>16.03 sérülés, törés a csővégen</b> <ul style="list-style-type: none"> <li>■ sérülés anyagfolytonossági hiány miatt</li> <li>■ vagy repedés, vágás miatt</li> </ul>	 	 	 

# PERI bérleti kritériumok

## ST 100 máglyatorony-állvány



UP átlós merevítő ST 100 (019940)	leírás	teendő	fizetési kondíció	típus
	<b>16.04 rögzítőkampó elgörbült   hiányzik</b>	 710123 (pd 8 rögzítőék) 710910 (feszítő hüvely)	 088391 089042	
	<b>16.05 merevítő elhajlott</b>			
	<ul style="list-style-type: none"> <li>■ ≤ 3 mm</li> <li>■ Or &gt; 3 mm (L/500)</li> </ul>	  	 088244  	  
	<b>16.06 kapcsolati pontnál elgörbült / törött</b>			
<ul style="list-style-type: none"> <li>■ ≤ 5 mm</li> <li>■ vagy &gt; 5 mm</li> </ul>	  	 088244  	  	

# PERI bérleti kritériumok

## ST 100 máglyatorony-állvány



UP keresztfejes fejtámasz (019950)	leírás	teendő	fizetési kondíció	típus	
	16.07 fül	<ul style="list-style-type: none"> <li>hajlás a hegesztés törése nélkül</li> </ul>		088395	
	<ul style="list-style-type: none"> <li>vagy hajás a hegesztés törésével</li> </ul>		088394		
	<ul style="list-style-type: none"> <li>vagy hiányzik</li> </ul>		088394		
	16.08 alap lemez hajlása	<ul style="list-style-type: none"> <li>&gt; 5 mm</li> </ul>			

# PERI bérleti kritériumok

## ST 100 máglyatorony-állvány



UP keresztfejes fejtámasz (019950)	leírás	teendő	fizetési kondíció	típus
------------------------------------	--------	--------	-------------------	-------



16.09 csavarorsó hajlott



16.10 csavarorsó teljes rövidítése illetve a menet sérülése



# PERI bérleti kritériumok

## ST 100 máglyatorony-állvány



csavaros talp TR 38-70/50 (019780)	leírás	teendő	fizetési kondíció	típus
------------------------------------	--------	--------	-------------------	-------



16.11 szárnyas csavar eltört, repedt, hajlott

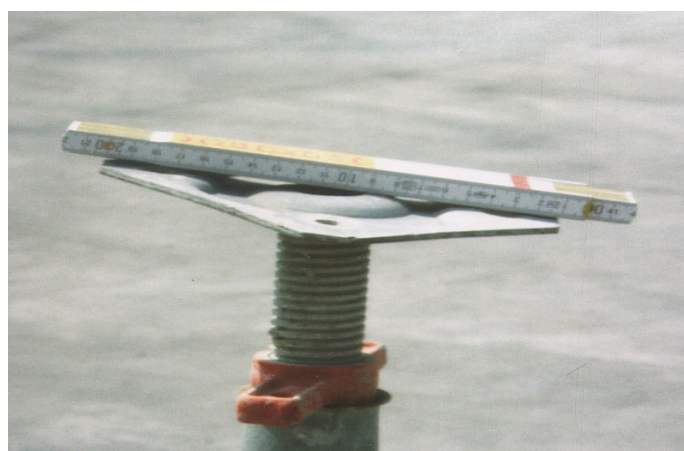

16.12 alaplemez

■ görbült (a csavarmenet nem érintett a sérülésben)



088244



■ ha görbült és a menet érintett



■ ha megtört a hegesztésnél



# PERI bérleti kritériumok

## ST 100 máglyatorony-állvány



Csav. fejtámasz, fejtámasz-2 (319790; 116081) leírás	teendő	fizetési kondíció	típus		
	<p>16.13 szárnyas csavar eltört, repedt, hajlott</p>				
	<p>16.14 körmök elhajlottak</p>			<p>088244</p>	
	<p>16.15 csavarmentet elhajlott</p>				



# PERI bérleti kritériumok

## ST 100 máglyatorony-állvány



heveder UH (Az UH szerepét az ST100 esetében a keret tölti be ezért arra az UH mindenkori kritériumai a mérvadóak!)

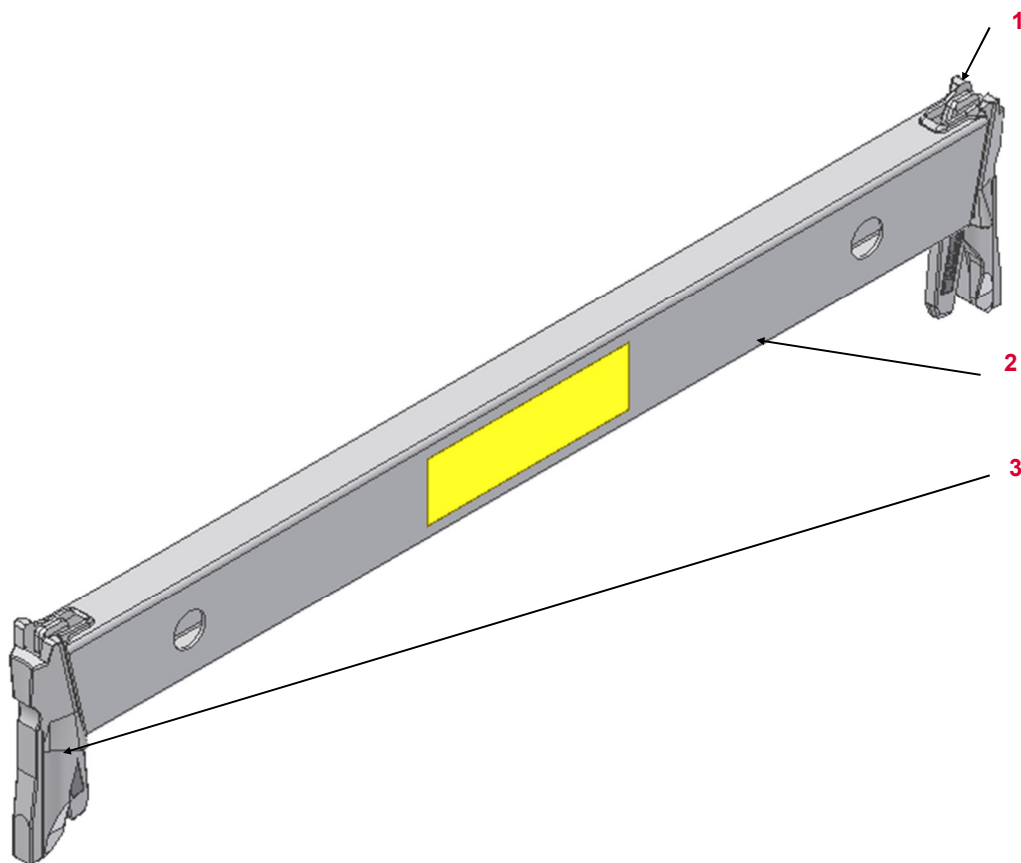









sorsz.	név	cikkszám
1	ék	100109
2	zártszelvény	
3	ék-ház	100018

Valid for	
heveder UH 72	100440
heveder UH 104	100192
heveder UH 150	100021
heveder UH 200	100023
heveder UH 250	100025
heveder UH 300	100027
heveder UH 400	100029
heveder UH 75	100017
heveder UH 100	101159

# PERI bérleti kritériumok

## ST 100 máglyatorony-állvány







heveder UH (Az UH szerepét az ST100 esetében a keret tölti be ezért arra az UH mindenkor kritériumai a mérvadóak!)	leírás	teendő	fizetési kondíció	típus
	16.16 sérülés, horpadás a profilban	 		
	16.17 törés az ékben, kinyílt   esetleg ék hiányzik			

# PERI bérleti kritériumok

## ST 100 máglyatorony-állvány





heveder UH (Az UH szerepét az ST100 esetében a keret tölti be ezért arra az UH mindenkorai kritériumai a mérvadóak!)	leírás	teendő	fizetési kondíció	típus
	16.18 sérülés amelyben a profil éle érintett			

# PERI bérleti kritériumok

## ST 100 máglyatorony-állvány

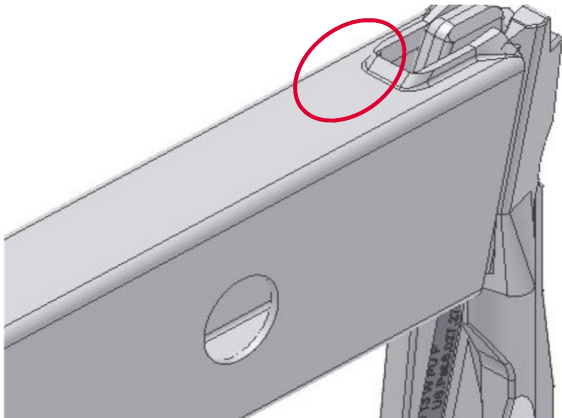

heveder UH (Az UH szerepét az ST100 esetében a keret tölti be ezért arra az UH mindenkor kritériumai a mérvadóak!)	leírás	teendő	fizetési kondíció	típus	
	<b>16.19 hajlás az éknél</b>				
	■ ha lehetséges			088244	
	■ ha nem lehetséges				
	■ ha eltört, hiányos az anyag				
	<b>16.20 hajlás a fogadólyuknál</b>				
	■ ha a furat geometriája nem változott jelentősen			088244	
	■ ha a geometria megváltozott				
	■ ha törés/vágás van az anyagban				

# PERI bérleti kritériumok

## ST 100 máglyatorony-állvány



heveder UH (Az UH szerepét az ST100 esetében a keret tölti be ezért arra az UH mindenkorai kritériumai a mérvadóak!)



leírás	teendő	fizetési kondíció	típus
--------	--------	-------------------	-------

### 16.21 heveder (lapjára) hajlott

- élék nem érintettek
- és a hajlás mértéke  $\leq L/300$



- ha  $>$  mint az engedélyezett hajlás





elem	Megengedett hajlás
heveder UH 25	$\leq 3$ mm
heveder UH 50	$\leq 3$ mm
heveder UH 75	$\leq 3$ mm
heveder UH 100	$\leq 3$ mm
heveder UH 125	$\leq 4$ mm
heveder UH 150	$\leq 5$ mm
heveder UH 200	$\leq 7$ mm
heveder UH 250	$\leq 8$ mm
heveder UH 300	$\leq 10$ mm

# PERI bérleti kritériumok

## ST 100 máglyatorony-állvány





















heveder UH (Az UH szerepét az ST100 esetében a keret tölti be ezért arra az UH mindenkorai kritériumai a mérvadóak!)	leírás	teendő	fizetési kondíció	típus
	16.22 profil (élére) elhajlott			

# PERI bérleti kritériumok

## ST 100 máglyatorony-állvány



áthelyező kerék UEW (116176)	leírás	teendő	fizetési kondíció	típus
	<b>16.23 kerék</b> <ul style="list-style-type: none"> <li>■ Törés, repedés, hajlás a kerék túlterhelése miatt (véltetően)</li> </ul>			
	<ul style="list-style-type: none"> <li>■ Ha elkopott, elhasználódott</li> </ul>			
	<b>16.24 cső</b> <ul style="list-style-type: none"> <li>■ görbület</li> </ul>			
	<ul style="list-style-type: none"> <li>■ ha lyukak vannak rajta</li> </ul>			
	<b>16.25 kerékrögzőítő lemeze/ funkciója sérült</b>			

# PERI bérleti kritériumok

## ST 100 máglyatorony-állvány



### áthelyezőkerék—csatlakozó ST 100 (116800)

sorsz.      név      cikkszám

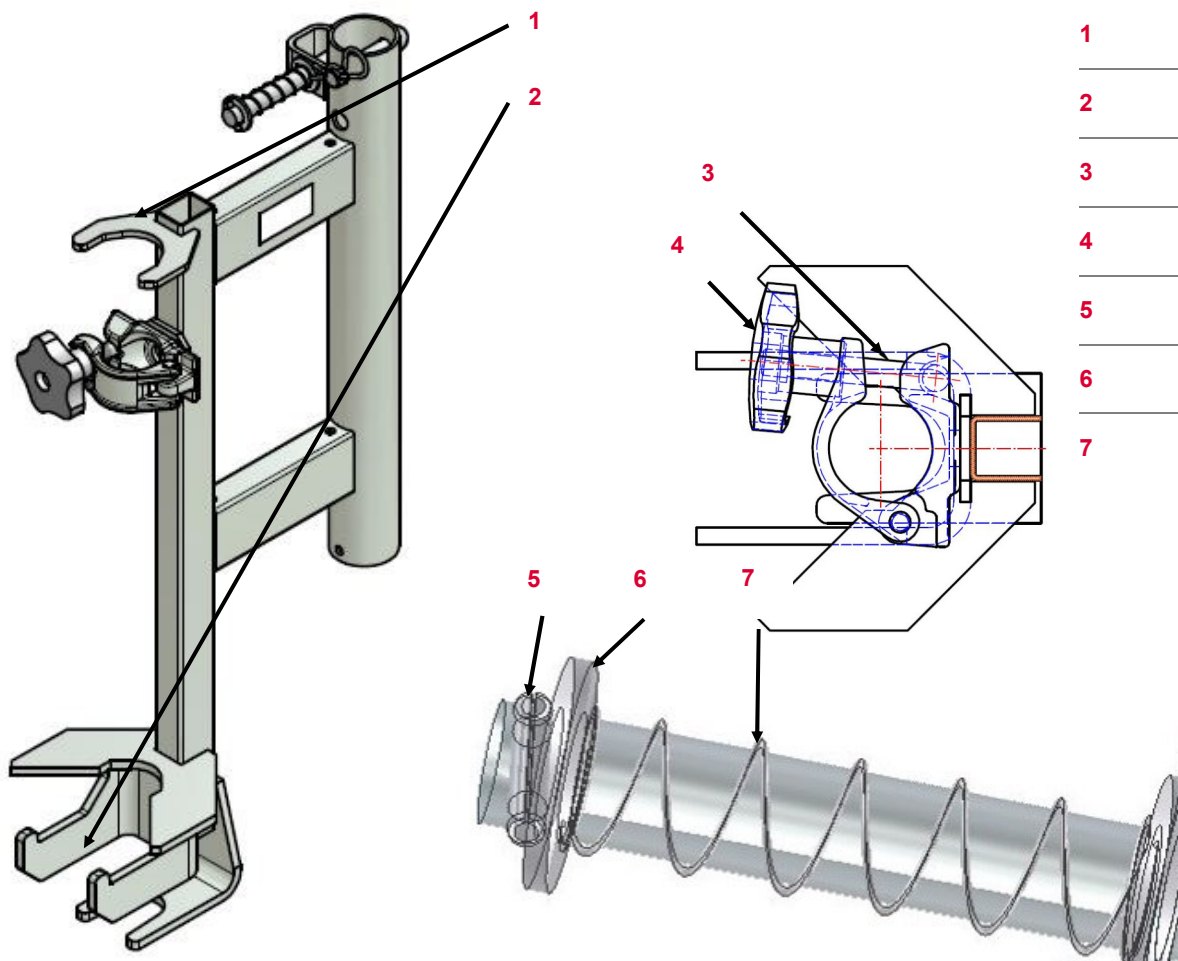









1	fogadólemez felső	
2	fogadólemez alsó	
3	kalapácsfejű csavar	710702
4	csillag fogantyú	117388
5	feszítőhüvely	721925
6	tisztító	711043
7	rugó	116177

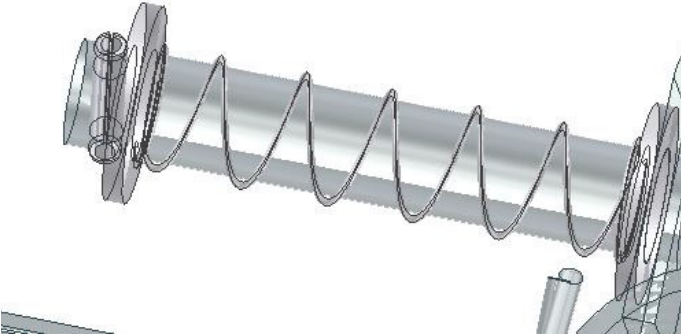

# PERI bérleti kritériumok

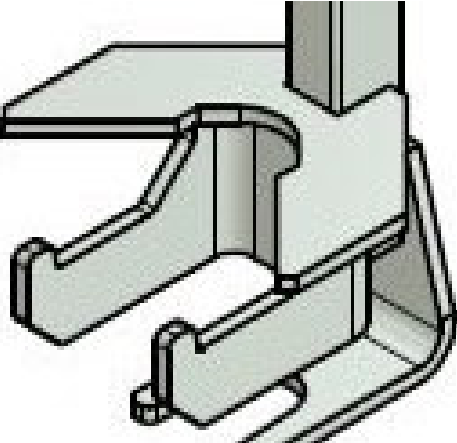
## ST 100 máglyatorony-állvány



















áthelyezőkerék—csatlakozó ST 100	leírás	teendő	fizetési kondíció	típus
	16.26 sérült rugó			
	16.27 fogadólemezek (alsó/ felső) elgörbült		 088244	

# PERI bérleti kritériumok

## Magyarázat



Ikon	Jelentés	Ikon	Jelentés	Ikon	Jelentés
	Nem Ok– selejtezendő		Ügyfél felé számlázandó		Optikai kár
	OK– marad a bérleti parkban		Nincs számlázás		Funkcionális sérülés
	Selejt anyag–biztonsági okokból az anyagot tilos kiadni		Anyagot levágni		Funkcionális sérülés— az anyag kiadása nem engedélyezett
	Javítás az előírások szerint		Anyagot megjelölni		Statikai sérülés— az anyag kiadása nem engedélyezett
	Hideg egyengetés—utána a varratokat és a környékét ellenőrizni kell		Sérült anyag cseréje		
	Javítás gazdaságosság függvényében		Hiányzó anyag pótlása		
	Megtisztítani az anyagot				