

PERI Bérleti kritériumok

PERI UP Homlokzati állvány Easy



Kapcsolat

PERI kft,
zszaluzatok, állványzatok,
mérnöki szolgáltatás

H-1181 Budapest
Zádor u. 9.
Tel.: +36-1-296-09-60
www.peri.hu

Tartalom	Oldal	Változtatások	Dátum ü	Oldal
Járótábla EDS	2	Új verzió	07/2021 Sz.L.	
Kombi tábla EDW	7	Módosítva 18. oldal	10/2021 V2A	
Zárókeret elemei	10			
Létrafeljáró Feljáró	13			
Átlós merevítő	19			
Korlátrúd	21			
Tartozékok	25			
Magyarázat	34			

PERI Bérleti kritériumok

PERI UP Homlokzati állvány Easy



Járótábla EDS

Sorszám Megnevezés Cikkszám

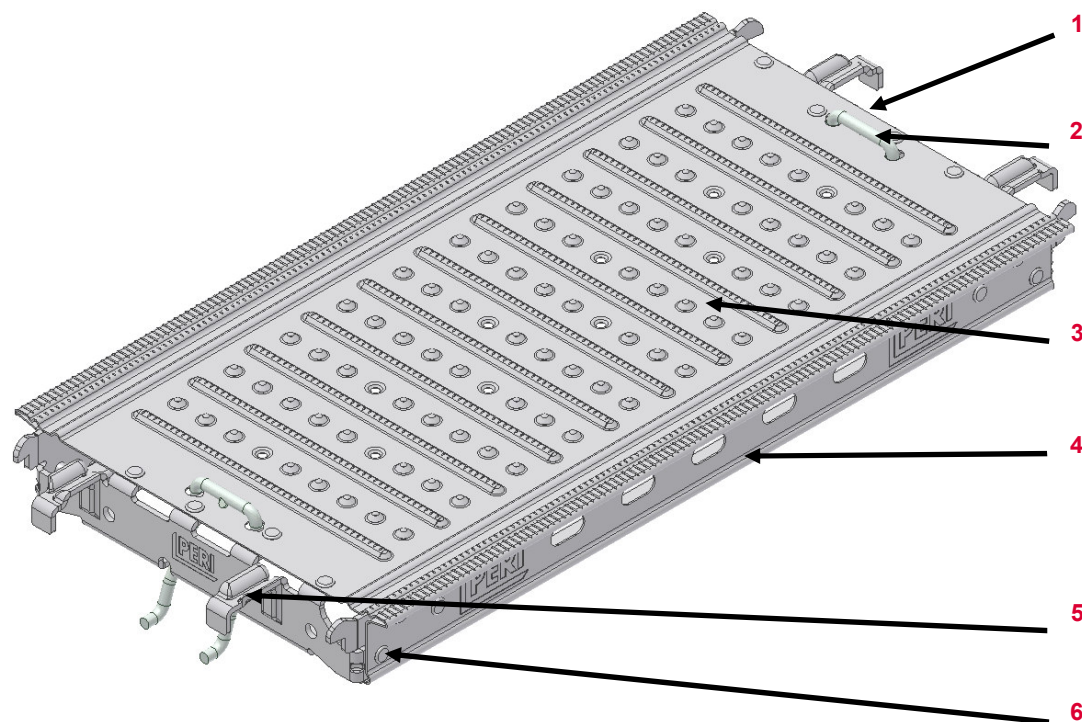

1	Akasztó EDS	129808
2	Biztosító fül	108716
3	Járófelület	
4	Oldalprofil	
5	Kapcsoló fül	108716
6	Szegecs 6,0x 10	723058



Megnevezés Cikkszám

Járótábla EDS 33x67	130450
Járótábla EDS 33x100	130448
Járótábla EDS 33x150	130445
Járótábla EDS 33x200	130441
Járótábla EDS 33x250	130438
Járótábla EDS 33x300	129272

PERI Bérleti kritériumok

PERI UP Homlokzati állvány Easy











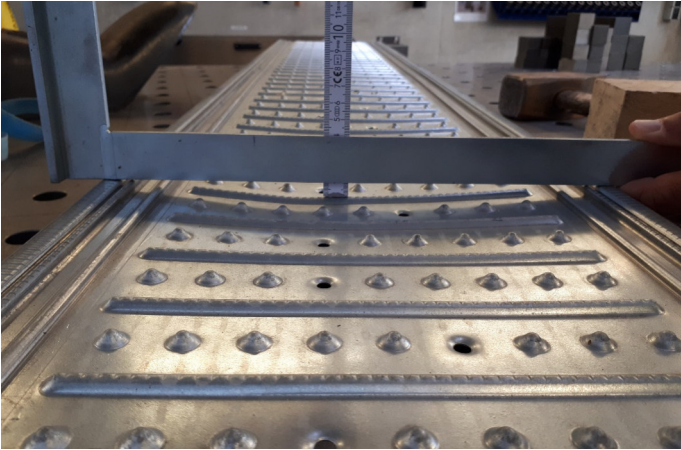







Járótábla EDS	Leírás	Instrukció	Fizetési kondíciók	Típus												
	Profil éle hosszanti irányban elgörbült															
	<ul style="list-style-type: none"> ■ A járótábla beillesztése lehetséges és nem sérült a TOX kapcsolat 															
	<ul style="list-style-type: none"> ■ Ha a járótábla beillesztése nem lehetséges 															
	<ul style="list-style-type: none"> ■ Sérült a TOX kapcsolat 															
	Elgörbült az él a felső oldalon															
	<ul style="list-style-type: none"> ■ < megengedett görbület (L/250) ■ Ha > mint a megengedett görbület 	 	 	 												
	<table border="1"> <thead> <tr> <th>Cikk</th> <th>Görbület mért.</th> </tr> </thead> <tbody> <tr> <td>EDS 67 100</td> <td>5 mm</td> </tr> <tr> <td>EDS 150</td> <td>6 mm</td> </tr> <tr> <td>EDS 200</td> <td>8 mm</td> </tr> <tr> <td>EDS 250</td> <td>10 mm</td> </tr> <tr> <td>EDS 300</td> <td>12 mm</td> </tr> </tbody> </table>	Cikk	Görbület mért.	EDS 67 100	5 mm	EDS 150	6 mm	EDS 200	8 mm	EDS 250	10 mm	EDS 300	12 mm			
Cikk	Görbület mért.															
EDS 67 100	5 mm															
EDS 150	6 mm															
EDS 200	8 mm															
EDS 250	10 mm															
EDS 300	12 mm															

PERI Bérleti kritériumok

PERI UP Homlokzati állvány Easy

















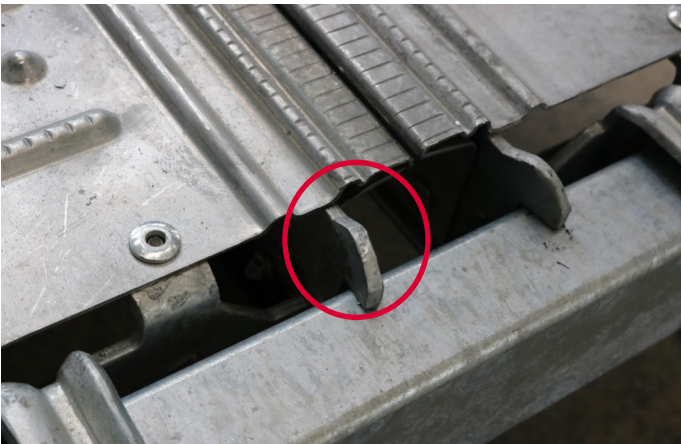

Járótábla EDS	Leírás	Instrukció	Fizetési kondíciók	Típus
	Görbület a járótáblán a rövid éllel párhuzamosan <ul style="list-style-type: none"> ■ ≤ 15 mm (tegye a vonalzót/ derékszöget a járófelületre és kövesse a képet) 	 Csak egyszer javítható, második alkalommal selejt		
	<ul style="list-style-type: none"> ■ Ha > 15 mm 			
	<ul style="list-style-type: none"> ■ Ha a borda sérült 			
	<ul style="list-style-type: none"> ■ Ha ≤ 15 mm (második alkalommal) 			
	Felület csavarodott			

PERI Bérleti kritériumok

PERI UP Homlokzati állvány Easy









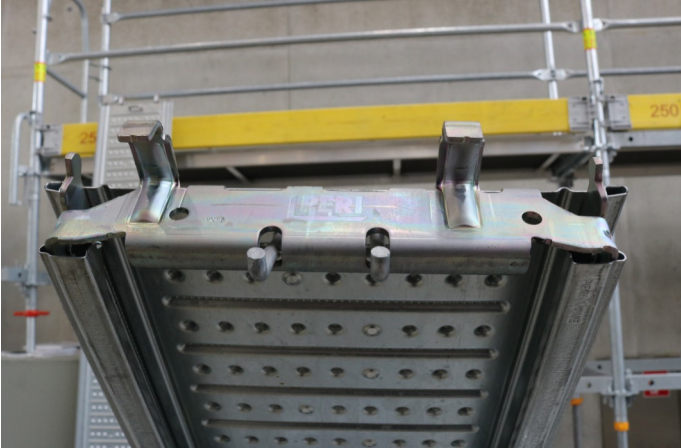

Járótábla EDS	Leírás	Instrukció	Fizetési kondíciók	Típus
	Kapcsoló fül elgörbült <ul style="list-style-type: none"> ■ ≤ 5 mm 			
	<ul style="list-style-type: none"> ■ Ha törés, repedés van a fülön 			
	<ul style="list-style-type: none"> ■ Ha > 5 mm 			
	Akaszókampó elgörbült <ul style="list-style-type: none"> ■ Törés nem látható az anyagon 			
	<ul style="list-style-type: none"> ■ A kampó repedt, eltört 			

PERI Bérleti kritériumok

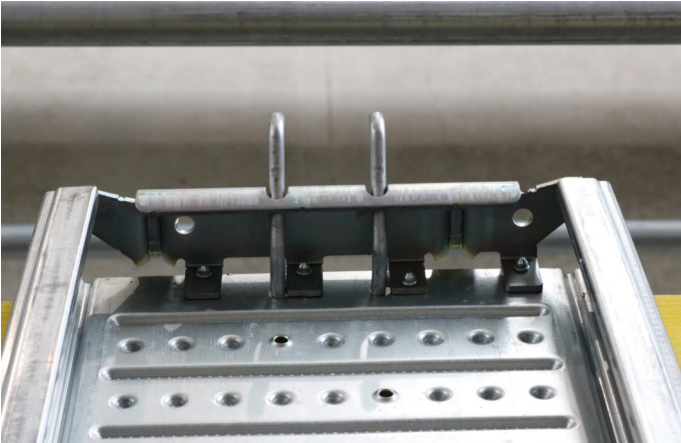
PERI UP Homlokzati állvány Easy



Járótábla EDS	Leírás	Instrukció	Fizetési kondíciók	Típus
	Biztosító fül elgörbült			
	Biztosító fül elgörbült használhatatlan			

PERI Bérleti kritériumok

PERI UP Homlokzati állvány Easy



Kombi tábla EDW

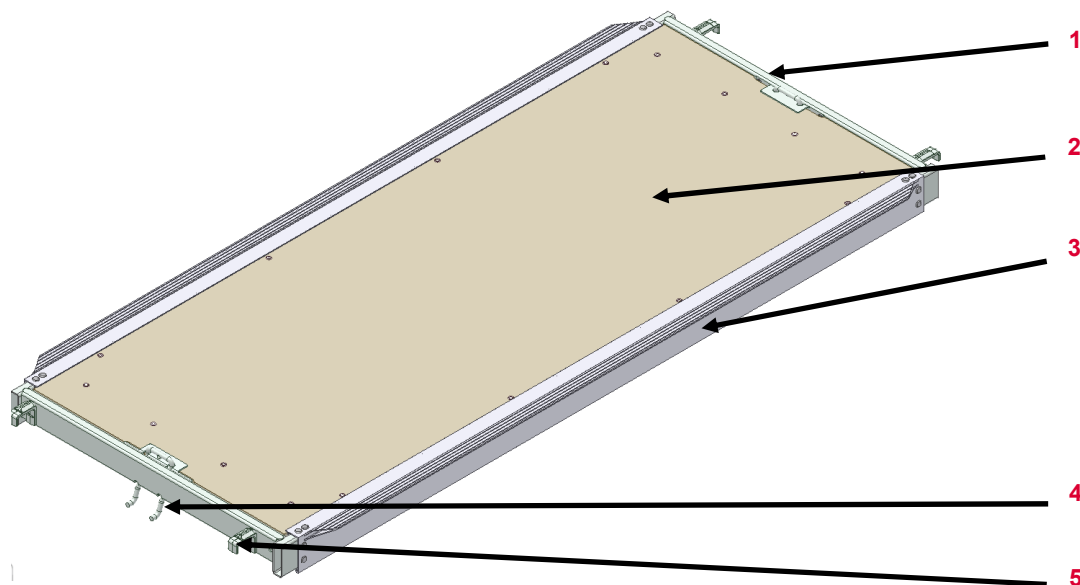

Sorszám	Megnevezés	Cikkszám
1	Kapcsoló elem kpl. EDW	130308
2	Járófelület	
3	Oldal profil	
4	Biztosító fül	
5	Kapcsoló fül	

Cikk	Cikkszám
Kombi tábla EDW 150	130321
Kombi tábla EDW 200	130317
Kombi tábla EDW 250	130313
Kombi tábla EDW 300	130309

PERI Bérleti kritériumok

PERI UP Homlokzati állvány Easy























Kombi tábla EDW	Leírás	Instrukció	Fizetési kondíciók	Típus
	Élprofil elgörbült			
	<ul style="list-style-type: none"> ■ A tábla beillesztése lehetséges 			
	<ul style="list-style-type: none"> ■ Ha a tábla beillesztése nem lehetséges 			
	<ul style="list-style-type: none"> ■ Ha az anyag megrepedt 			
	Járófelület			
	<ul style="list-style-type: none"> ■ Elhasználódás esetén 			
	<ul style="list-style-type: none"> ■ Erőbehatás következtében eltört / átszakadt rétegelt lemez 			

PERI Bérleti kritériumok

PERI UP Homlokzati állvány Easy



Kombi tábla EDW	Leírás	Instrukció	Fizetési kondíciók	Típus
	Kapcsoló elem elhajlott <ul style="list-style-type: none"> ■ ≤ 5 mm és nincs repedés az elemen 			
	<ul style="list-style-type: none"> ■ ha > 5 mm ■ ha repedés van az elemen 			
	Biztosító fül <ul style="list-style-type: none"> ■ Deformálódott és egyengethető 			
	<ul style="list-style-type: none"> ■ Nem egyengethető vagy hiányzik 			
	Hegesztés eltört a csatlakozásnál <ul style="list-style-type: none"> ■ Borda deformáció miatt 			
	<ul style="list-style-type: none"> ■ Deformáció nélkül 			

PERI Bérleti kritériumok

PERI UP Homlokzati állvány Easy



Záró keret EVH | T-keret EVF | Alapkeret EVB | Cső EVR

Sorszám Megnevezés Cikkszám

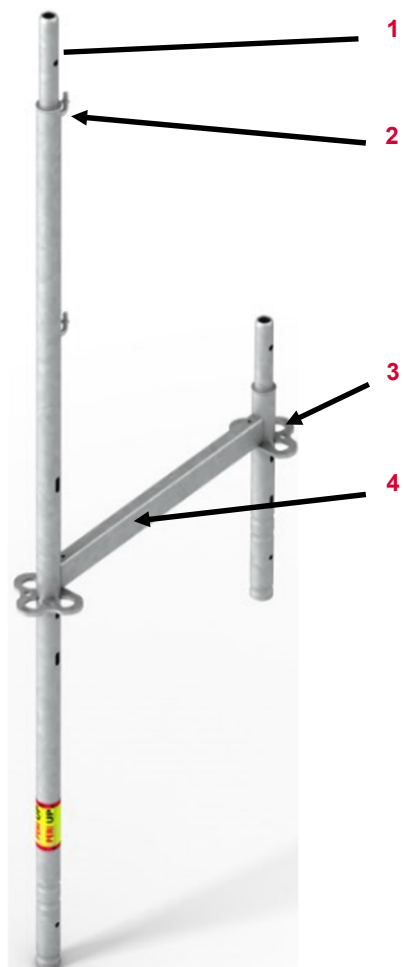













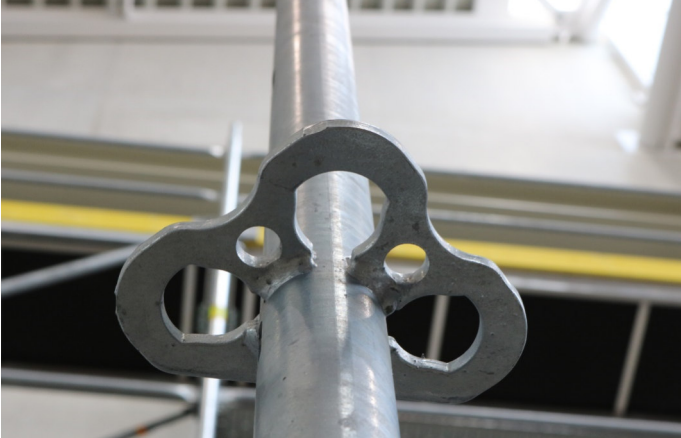

- | | |
|---|---------------------|
| 1 | Csővég |
| 2 | Védőkoriát akasztó |
| 3 | 3/4 Rozetta |
| 4 | Vízszintes szelvény |

Megnevezés	Cikkszám
Zárókeret EVH 67	129314
Zárókeret EVH 100	130804
T-keret EVF 67	130466
T-keret EVF 100	130860
Alapkeret EVB 67	130518
Alapkeret EVB 100	130858
Belső cső EVR 150	130481
Kiegészítő keret EVA 64/50	130522
Kiegészítő keret EVA 67/100	130526
Kiegészítő keret EVA 100/50	130854
Kiegészítő keret EVA 100/100	130856
Korlátozószlop EVP	130512
Konzol ECM 33	130378
Konzol ECM 67	130372
Konzol ECM 100	130365
Kieg. alaprúd EVS 124	130619
Kieg. rúd EVM 200	130621

PERI Bérleti kritériumok

PERI UP Homlokzati állvány Easy



















Keret elemek	Leírás	Instrukció	Fizetési kondíciók	Típus
	<p>Csővég csatlakozás elgörbült</p> <ul style="list-style-type: none"> ■ minden látható deformáció 			
	<p>Rozetta deformálódása</p> <ul style="list-style-type: none"> ■ ha lehetséges ■ ha a hegesztés eltört ■ ha a görbület > 20 mm 	  	  	  

PERI Bérleti kritériumok

PERI UP Homlokzati állvány Easy



Keret elemei	Leírás	Instrukció	Fizetési kondíciók	Típus
	Védőkoriát akasztó fül görbülése			
	<ul style="list-style-type: none"> ■ ha lehetséges 			
	<ul style="list-style-type: none"> ■ anyag eltörése hegesztési sérülés 			
	Vízszintes szelvény horpadása			
	<ul style="list-style-type: none"> ■ $\varnothing \leq 3$ cm 			
	<ul style="list-style-type: none"> ■ ha eltört 			
	<ul style="list-style-type: none"> ■ ha a vízszintes szelvény éle érintett 			

PERI Bérleti kritériumok

PERI UP Homlokzati állvány Easy



Látrafeljáró EAW | Feljáró EAW

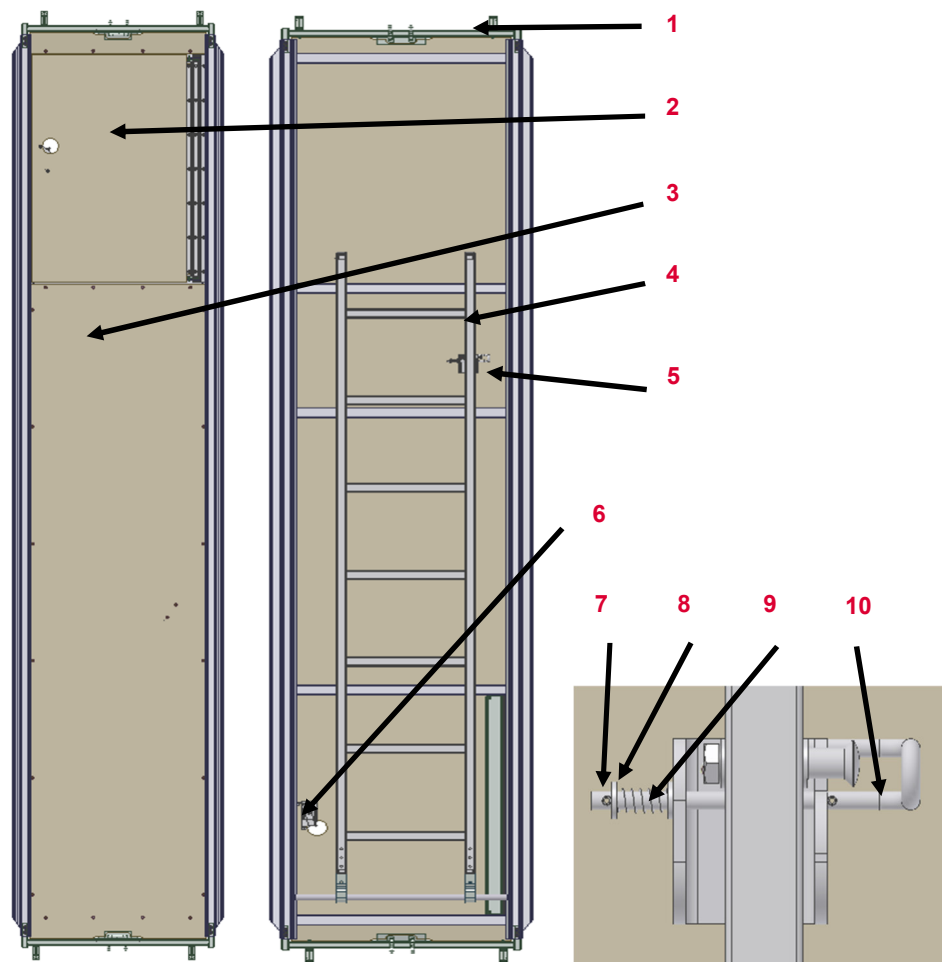











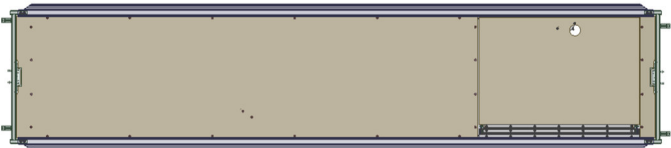

Sorszám	Megnevezés	Cikkszám
1	Kapcsoló elem kpl.	130308
2	Búvónyílás	130412
3	Rétegelt lemez járófelület	
4	Létra EAL	130419
5	Létra zár	130423
6	Zár UAL	115566
7	Hasított ék	130356
8	Alátét	721633
9	Rugó	130386
10	Biztosító fül	130422

Cikk	Cikkszám
létrafeljáró EAW-L 250	130431
létrafeljáró EAW-L 300	130425
feljáró tábla EAW 200	130426

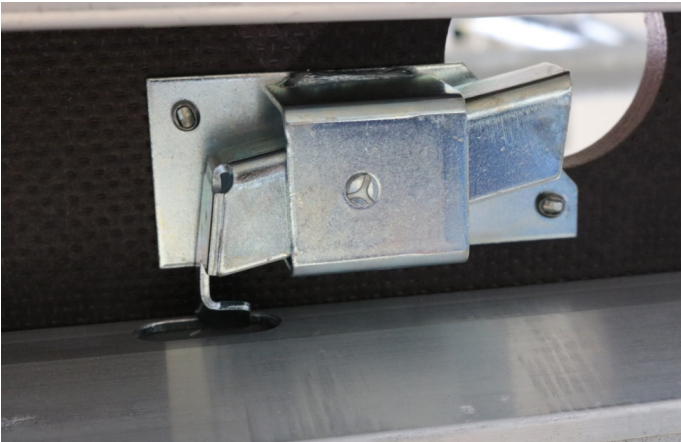
PERI Bérleti kritériumok

PERI UP Homlokzati állvány Easy























Létrafeljáró EAW Feljáró EAW	Leírás	Instrukció	Fizetési kondíciók	Típus
	<p>lemez/nyílás</p> <ul style="list-style-type: none"> ■ elhasználódás 	 <p>130412 (Ajtó) 130407 (Rétegelt lemez EAW 300) 130427 (Rétegelt lemez EAW 250)</p>		
	<ul style="list-style-type: none"> ■ erőhatás miatti törés 	 <p>130412 (Ajtó) 130407 (Rétegelt lemez EAW 300) 130427 (Rétegelt lemez EAW 250)</p>		
	<p>Zár nem működik</p> <ul style="list-style-type: none"> ■ elhasználódás 			
	<ul style="list-style-type: none"> ■ sérülés erőhatás miatt 			

PERI Bérleti kritériumok

PERI UP Homlokzati állvány Easy

















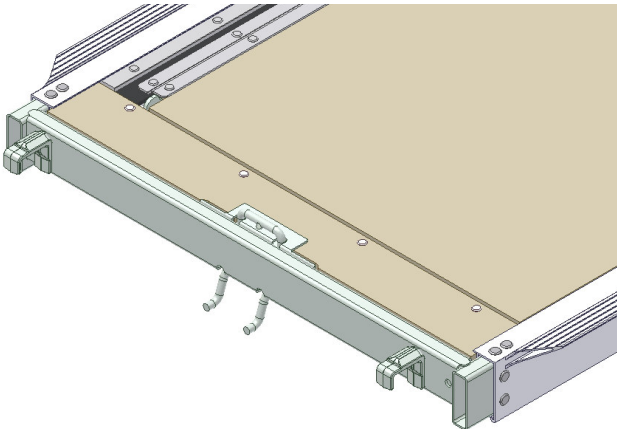

Létra feljáró EAW Feljáró szint EAW	Leírás	Instrukció	Fizetési kondíciók	Típus
	Létra zár <ul style="list-style-type: none"> ■ Nem funkcionál elhasználódás miatt 			
	<ul style="list-style-type: none"> ■ Vagy erőszak miatt nem működik 			
	<ul style="list-style-type: none"> ■ Vagy hiányzó alkatrészek 			
	Merevítő eldeformálódott <ul style="list-style-type: none"> ■ Ha lehetséges 			
	<ul style="list-style-type: none"> ■ Vagy hegesztés megrepedt 			
	<ul style="list-style-type: none"> ■ Vagy csavarodott 			

PERI Bérleti kritériumok

PERI UP Homlokzati állvány Easy











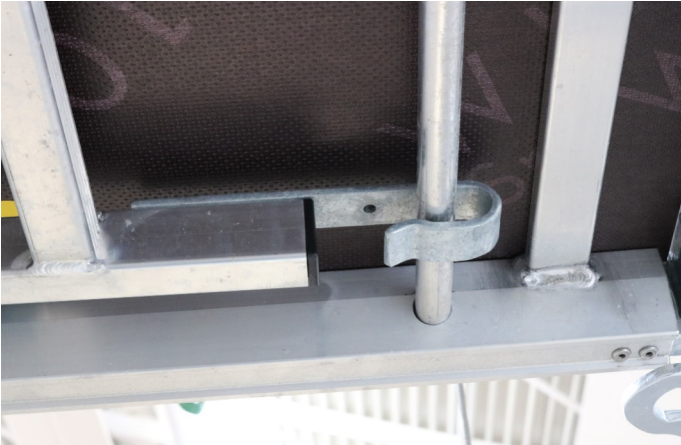









Létra feljáró EAW Feljáró szint EAW	Leírás	Instrukció	Fizetési kondíciók	Típus
	Kapcsoló fül deformálódott			
	<ul style="list-style-type: none"> ■ ≤ 5 mm 			
	<ul style="list-style-type: none"> ■ Vagy > 5 mm 			
	<ul style="list-style-type: none"> ■ Vagy repedések a fülön 			
	Biztosító fül elgörbült nem funkcionál			
	<ul style="list-style-type: none"> ■ ha lehetséges 			
	<ul style="list-style-type: none"> ■ Ha nem lehetséges vagy hiányzik 			

PERI Bérleti kritériumok

PERI UP Homlokzati állvány Easy



Feljáró szint EAW	Leírás	Instrukció	Fizetési kondíciók	Típus
	Létra akasztója elgörbült <ul style="list-style-type: none"> ■ Ha lehetséges 			
	<ul style="list-style-type: none"> ■ Ha nem lehetséges 	 130417 (Akasztó fül Easy) 104280 (Szegecs 6,0x12)		
	Létrafok deformálódott <ul style="list-style-type: none"> ■ Nincs repedés a hegesztésben 	 		
	<ul style="list-style-type: none"> ■ Vagy repedéssel 			
	<ul style="list-style-type: none"> ■ Vagy csavarodás 			

PERI Bérleti kritériumok

PERI UP Homlokzati állvány Easy



Feljáró szint EAW	Leírás	Instrukció	Fizetési kondíciók	Típus
	Létra akasztócsöve megsérült, elgöbült	 132589 / EAW 67 132974 / EAW 75		

PERI Bérleti kritériumok

PERI UP Homlokzati állvány Easy



Átlós merevítő EBF

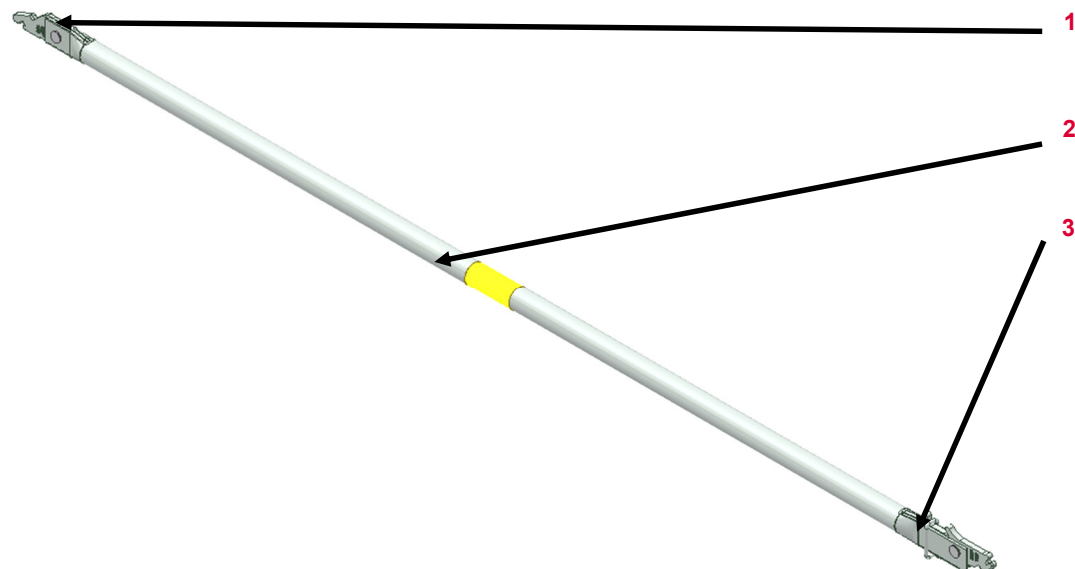

Sorszám	Megnevezés	Cikkszám
---------	------------	----------

- | | |
|---|----------------------|
| 1 | Átlós fej alsó rész |
| 2 | Cső |
| 3 | Átlós fej felső rész |

Cikk	Cikkszám
Átlós merevítő EBF 150/200	130162
Átlós merevítő EBF 200/200	130171
Átlós merevítő EBF 250/200	130180
Átlós merevítő EBF 300/200	130189

PERI Bérleti kritériumok

PERI UP Homlokzati állvány Easy



Átlós merevítő EBF	Leírás	Instrukció	Fizetési kondíciók	Típus
--------------------	--------	------------	--------------------	-------



Átlós fej nem funkcionál

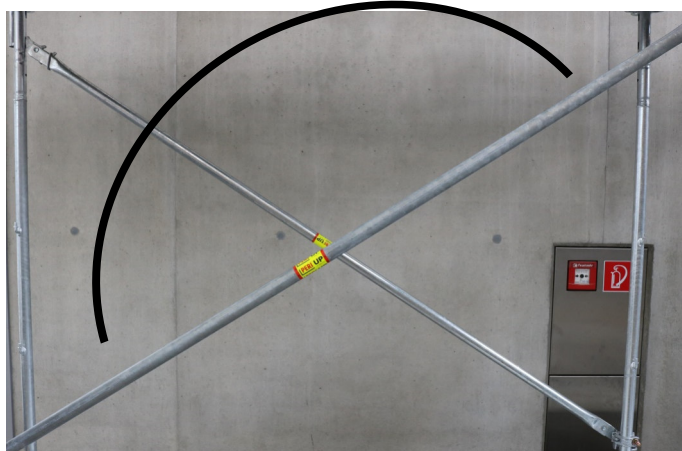

Átlós merevítő elgörbült

■ \leq megengedett görbület (L/500)



■ Vagy $>$ megeng. görbület (L/500)



Cikk	Megengedett görbület
Átlós merevítő EBF 150/200	4 mm
Átlós merevítő EBF 200/200	5 mm
Átlós merevítő EBF 250/200	6 mm
Átlós merevítő EBF 300/200	7 mm

PERI Bérleti kritériumok

PERI UP Homlokzati állvány Easy



Korlátrúd EPG

Sorszám

Megnevezés

Cikkszám

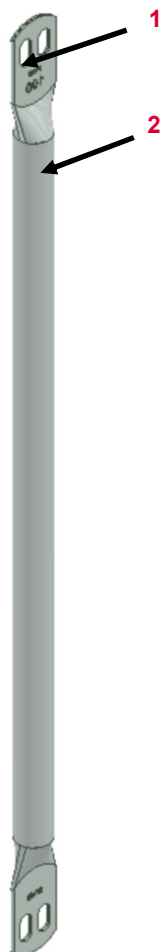

1 Csatlakozó

2 Cső

Cikk

Cikkszám

Korlátrúd EPG 67

130191

Korlátrúd EPG 100

130193

Korlátrúd EPG 150

130195

Korlátrúd EPG 200

130197

Korlátrúd EPG 250

130199

Korlátrúd EPG 300

130201

PERI Bérleti kritériumok

PERI UP Homlokzati állvány Easy



Korlátrúd EPG	Leírás	Instrukció	Fizetési kondíciók	Típus
---------------	--------	------------	--------------------	-------



Csatlakozó deformálódott

■ Ha lehetséges



■ Ha nem lehetséges



Védőkorlát elgörbült

■ > megengedett görbület (L/250)



Megnevezés	Megengedett görbület
Korlátrúd EPG 67	3 mm
Korlátrúd EPG 100	4 mm
Korlátrúd EPG 150	6 mm
Korlátrúd EPG 200	8 mm
Korlátrúd EPG 250	10 mm
Korlátrúd EPG 300	12 mm

PERI Bérleti kritériumok

PERI UP Homlokzati állvány Easy



Végkorlát EPF

Sorszám

Megnevezés

Cikkszám

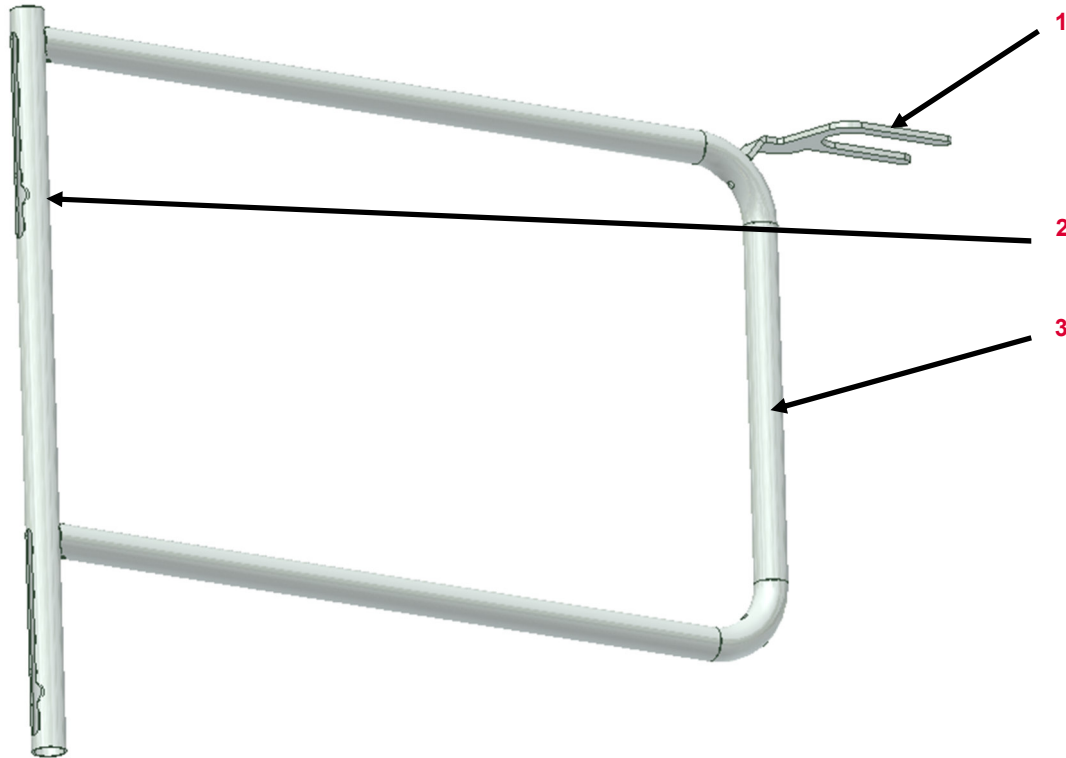

1

Villa

2

Cső















3

Keret

PERI Bérleti kritériumok

PERI UP Homlokzati állvány Easy











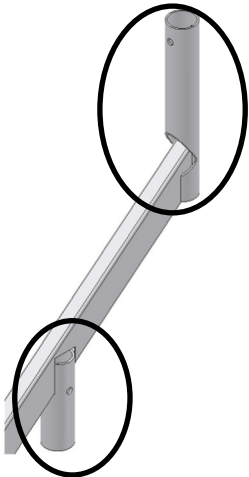

Végkorlát EPF	Leírás	Instrukció	Fizetési kondíciók	Típus
	Villa deformálódott <ul style="list-style-type: none"> ■ Ha lehetséges 			
	<ul style="list-style-type: none"> ■ Ha nem lehetséges 			
	Cső roncsolódott <ul style="list-style-type: none"> ■ Behelyezés lehetséges 			
	<ul style="list-style-type: none"> ■ Vagy nem lehetséges 			

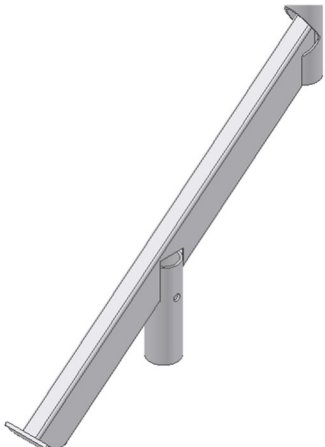
PERI Bérleti kritériumok

PERI UP Homlokzati állvány Easy



Védőtető konzol EPC (130385)	Leírás	Instrukció	Fizetési kondíciók	Típus
	<p>Csatlakozó csövek deformálódtak roncsolódtak</p> <ul style="list-style-type: none"> ■ Minden látható deformáció 			
	<p>Horpadás a szelvényen</p> <ul style="list-style-type: none"> ■ $\varnothing > 3 \text{ cm}$ 			
	<ul style="list-style-type: none"> ■ Vagy élek érintettek 			

PERI Bérleti kritériumok

PERI UP Homlokzati állvány Easy



Védőfal korlát EPS (130532)	Leírás	Instrukció	Fizetési kondíciók	Típus
	Korláttartó fül elgörbült <ul style="list-style-type: none"> ■ Ha lehetséges 			
	<ul style="list-style-type: none"> ■ Ha nem lehetséges 			
	Csap csatlakozó deformálódott <ul style="list-style-type: none"> ■ Minden látható deformáció 			
	Csomópont lap deformálódott <ul style="list-style-type: none"> ■ Ha lehetséges 			
	<ul style="list-style-type: none"> ■ Vagy ha nem lehetséges 			

PERI Bérleti kritériumok

PERI UP Homlokzati állvány Easy



Easy kikötőrúd bilincs EWC (130964)	Leírás	Instrukció	Fizetési kondíciók	Típus
-------------------------------------	--------	------------	--------------------	-------

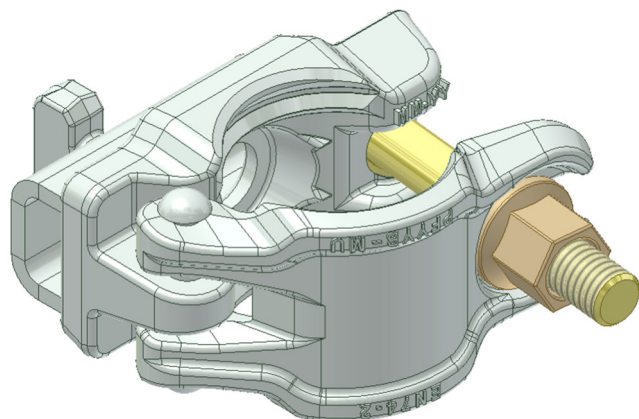

Csukló nem funkcionál

- Kopott
- Vagy erő miatt megsérült

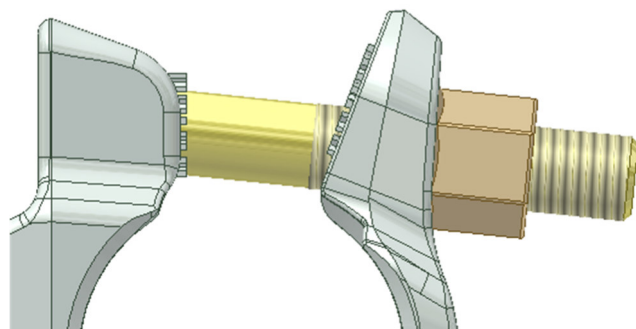

Kalapácsfejű csavar | anya

- Hiányzik
- Vagy sérült



131316 (Kalapácsfejű csavar)
710340 (Anya)

















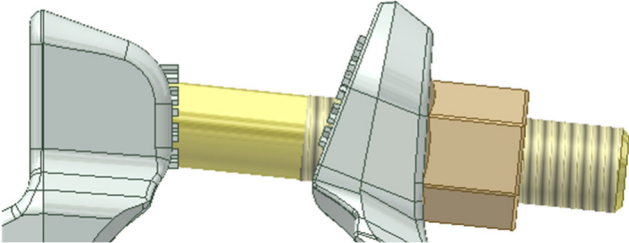

131316 (Kalapácsfejű csavar)
710340 (Anya)

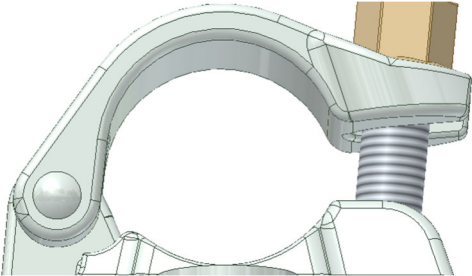

PERI Bérleti kritériumok

PERI UP Homlokzati állvány Easy



Korláttartó bilincs EPR (130434)	Leírás	Instrukció	Fizetési kondíciók	Típus
	Korláttartó fül elgörbült <ul style="list-style-type: none"> ■ Ha lehetséges 			
	<ul style="list-style-type: none"> ■ Vagy ha nem lehetséges 			
	Kalapácsfejű csavar Anya <ul style="list-style-type: none"> ■ Hiányzik 		117475 (kalapácsfejű csavar) 710340 (anya)	 
	<ul style="list-style-type: none"> ■ Vagy sérült 		117475 (kalapácsfejű csavar) 710340 (anya)	 
	Csukló nem funkcionál <ul style="list-style-type: none"> ■ Kopott 			
	<ul style="list-style-type: none"> ■ Vagy erő miatt sérült 			

PERI Bérleti kritériumok

PERI UP Homlokzati állvány Easy



Időjárás védelem (133753 133742 133745)	Leírás	Instrukció	Fizetési kondíciók	Típus
---	--------	------------	--------------------	-------

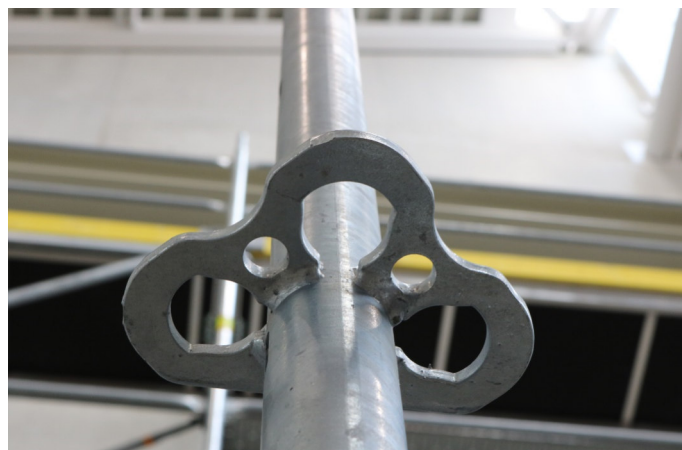

Rozetta deformálódott

- Ha lehetséges
- Vagy hegesztés / anyag repedt
- Vagy görbület > 20 mm

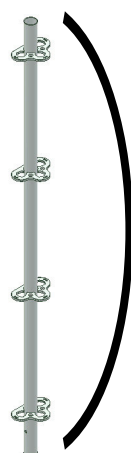

Teljes hosszban görbült









- $\leq 1/500$
- Vagy $> 1/500$



PERI Bérleti kritériumok

PERI UP Homlokzati állvány Easy



Kuplung EVW (133757)	Leírás	Instrukció	Fizetési kondíciók	Típus
	<p>Lemezek elgörbültek</p> <ul style="list-style-type: none"> ■ Ha lehetséges ■ Ha nem lehetséges 	 	 	 
	<p>Kalapácsfejű csavar anya hiányzik</p>			

PERI Bérleti kritériumok

PERI UP Homlokzati állvány Easy

















Lépcsőkoriát EAG (124558 124561)	Leírás	Instrukció	Fizetési kondíciók	Típus
	Csatlakozó deformálódott <ul style="list-style-type: none"> ■ Ha lehetséges 			
	<ul style="list-style-type: none"> ■ Ha nem lehetséges 			
	<ul style="list-style-type: none"> ■ Vagy repedés az anyagban 			
	Korlát elgörbült <ul style="list-style-type: none"> ■ $\leq 1/500$ 			
	<ul style="list-style-type: none"> ■ Vagy $> 1/500$ 			

PERI Bérleti kritériumok

PERI UP Homlokzati állvány Easy



Korlátkiegészítés UAH-2 (133543)	Leírás	Instrukció	Fizetési kondíciók	Típus
	Villa deformálódott <ul style="list-style-type: none"> ■ Ha lehetséges 			
	<ul style="list-style-type: none"> ■ Vagy ha nem lehetséges 			
	Retesz Csavar Anya <ul style="list-style-type: none"> ■ Hiányzik 	 133531 (retesz) 123978 (csavar) 711071 (anya)		
	<ul style="list-style-type: none"> ■ Vagy erő miatt sérült 	 133531 (retesz) 123978 (csavar) 711071 (anya)		

PERI Bérleti kritériumok

PERI UP Homlokzati állvány Easy



















UP Biztosító dugasz (133705)	Leírás	Instrukció	Fizetési kondíciók	Típus
	Deformálódott			

PERI Bérleti kritériumok

Magyarázat









Ikon	Jelentés	Ikon	Jelentés	Ikon	Jelentés
	Nem Ok– Selejtezendő		Ügyfélnek számlázandó		Optikai kár
	OK– marad a bérleti parkban		Nincs számlázás		Funkcionális sérülés
	Selejt anyag– biztonsági okokból az anyagot tilos kiadni		Anyagot levágni		Funkcionális sérülés— anyag kiadása nem engedélyezett
	Javítás az előírások szerint		Anyagot megjelölni		Statikai sérülés— anyag kiadása nem engedélyezett
	Hideg egyengetés– utána a varratokat és a környékét ellenőrizni kell		Sérült anyag cseréje		
	Javítás gazdaságosság függvényében		Hiányzó anyag pótlása		
	Megtisztítani az anyagot				

PERI Bérleti kritériumok

PERI UP Homlokzati állvány Easy



Schaden Xyyyyy	Leírás	Instrukció	Fizetési kondíciók	Típus
				
				

PERI Bérleti kritériumok

PERI UP Homlokzati állvány Easy



Stahlbelag EDS	Sorszám	Megnevezés	Cikkszám
	1	1	
	2	2	
	3	3	
	4	4	

PERI Bérleti kritériumok

PERI UP Homlokzati állvány Easy



Description	Instruction	Billing condition	Type
-------------	-------------	-------------------	------

PERI Bérleti kritériumok

PERI UP Homlokzati állvány Easy



Sorszám	Megnevezés	Cikkszám
1	Gurtholz	keine
2	Strebe	keine
3	Stahlkappe verzinkt	726041
4	Stahl-Rohrniet	726040

Schaden	Leírás	Instrukció	Fizetési kondíciók	Típus
---------	--------	------------	--------------------	-------

PERI Bérleti kritériumok

PERI UP Homlokzati állvány Easy



Kapcsolat

**PERI kft,
zsaluzatok, állványzatok,
mérnöki szolgáltatás**

H-1181 Budapest
Zádor u. 9.
Tel.: +36-1-296-09-60
www.peri.hu

Inhalt	Seite

Inhalt	Seite

PERI Bérleti kritériumok

PERI UP Homlokzati állvány Easy



Kapcsolat

PERI kft,
zsaluzatok, állványzatok,
mérnöki szolgáltatás

H-1181 Budapest
Zádor u. 9.
Tel.: +36-1-296-09-60
www.peri.hu

Vorgenommene Änderungen	Datum Kürzel, Wer	Seite
Neuerstellung Layout	07/2015 rf	

Vorgenommene Änderungen	Datum Kürzel, Wer	Seite
Neuerstellung Layout	07/2015 rf	

PERI Bérleti kritériumok

PERI UP Homlokzati állvány Easy



Kapcsolat

**PERI kft,
zsaluzatok, állványzatok,
mérnöki szolgáltatás**

H-1181 Budapest
Zádor u. 9.
Tel.: +36-1-296-09-60
www.peri.hu

Inhalt	Seite

Inhalt	Seite







Ab hier folgen die Seiten für die Schäden auf Basis der Gestaltungsvorlage für eine Zeile.

Die Abstände der Zeilen sind dadurch verschiebbar.

PERI Bérleti kritériumok

PERI UP Homlokzati állvány Easy



Schaden Xyyyyy	Leírás	Instrukció	Fizetési kondíciók	Típus
				
				

PERI Bérleti kritériumok

PERI UP Homlokzati állvány Easy



Schaden Xyyyyy	Leírás	Instrukció	Fizetési kondíciók	Típus

PERI Bérleti kritériumok

PERI UP Homlokzati állvány Easy



Schaden Xyyyyy	Leírás	Instrukció	Fizetési kondíciók	Típus

Ab hier folgen die Seiten für die Schäden auf Basis unterschiedlicher Gestaltungsvorlagen:

1 Zeile, 2 Zeilen, 3 Zeilen und 4 Zeilen

Die Abstände der Zeilen sind jeweils nicht verschiebbar.

PERI Bérleti kritériumok

PERI UP Homlokzati állvány Easy









Schaden Xyyyyy	Leírás	Instrukció	Fizetési kondíciók	Típus
------------------	--------	------------	--------------------	-------



PERI Bérleti kritériumok

PERI UP Homlokzati állvány Easy



Schaden	Description	Instruction	Billing condition	Type
				
				

PERI Bérleti kritériumok

PERI UP Homlokzati állvány Easy



Schaden	Description	Instruction	Billing condition	Type

PERI Bérleti kritériumok

PERI UP Homlokzati állvány Easy



Schaden	Description	Instruction	Billing condition	Type

