

PERI Bérleti Kritériumok

DUO



Kapcsolat

PERI kft,
zsaluzatok, állványzatok,
mérnöki szolgáltatás

H-1181 Budapest
Zádor u. 9.
Tel.: +36-1-296-09-60
www.peri.hu

Tartalom	Oldal	Változás	Dátum Initial	Oldal
Zsaluhéj	2	Új verzió	05/2021 Sz.L.	
Keretváz	16	Hozzáadott cikkszám	02/2016 fw	3;24
Tartozékok	24	Számos változás	08/2017	
Magyarázat	43	Hozzáadott cikkek	10/2018 fw	41-43

PERI Bérleti kritériumok

DUO



DUO tábla	No.	Név	Cikkszám
-----------	-----	-----	----------

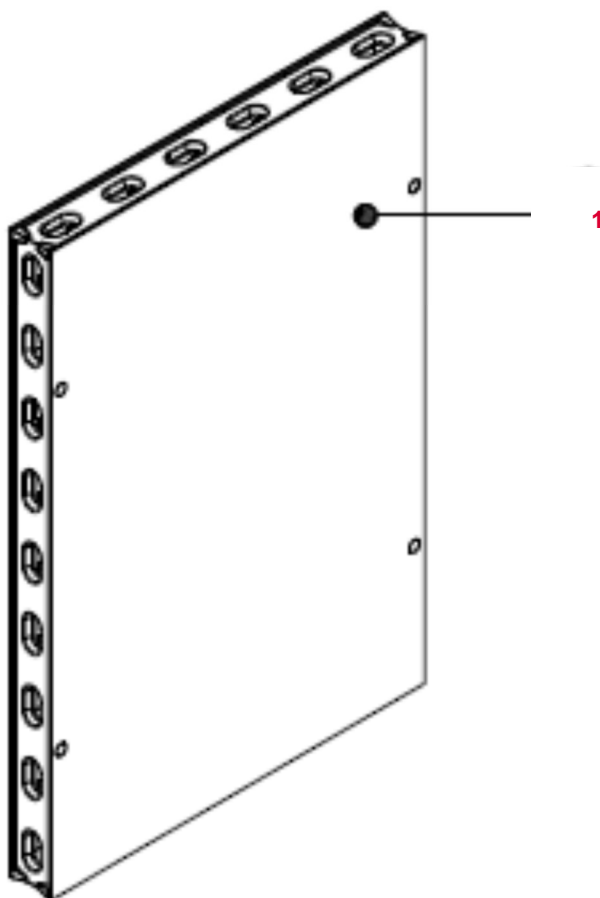









1	Tábla	Zsaluhéj
	DP 135x90	128228
	DMP 135x75	128229
	DP 135x60	128230
	DMP 135x45	128231
	DP 135x30	128232
	DP 135x15	128233

Érvényes	Cikkszám
Panel DP 135 x 90	128280
Multi Panel DMP 135 x 75	128281
Panel DP 135 x 60	128282
Multi Panel DMP 135 x 45	128283
Panel DP 135 x 30	128284
Panel DP 135 x 15	128285

PERI Bérleti kritériumok

DUO





















Zsaluhéj - szennyeződés	Leírás	Instrukció	Fietési Kondíció	Típus
	29.01 Enyhe szennyeződés			
	29.02 Erős szennyeződés(PERI Clean használatának mellőzése)		 088974	

PERI Bérleti kritériumok

DUO



Zsaluháj - szennyeződés	Leírás	Instrukció	Fietési Kondíció	Típus
	29.03 Betonnal szennyezett átkötési lyuk			
	29.04 Nem megfelelő formaválasztó szerek használata(Diesel, stb.)	 Zsaluháj csere	 Lásd táblázat (23 oldal)	

Zsaluhéj - felületi sérülések	Leírás	Instrukció	Fietési Kondíció	Típus
	<p>29.05 Sérülés a dugón.variábilis táblában ,túl közeli nagynyomású mosós tisztítás miatt</p>			
	<p>29.06 Bevágás a zsaluhéjon.Túl közeli nagynyomású mosós tisztítás miatt.</p> <ul style="list-style-type: none"> ■ $D \leq 1$ mm mélység 			
	<ul style="list-style-type: none"> ■ Vagy $D > 1$ mm mélység 			

Zsaluhéj - felületi sérülések	Leírás	Instrukció	Fietési Kondíció	Típus
	29.07 Betonvibrátor sérülések			
	<ul style="list-style-type: none"> ■ ≤ 1 mm mélység 			
	<ul style="list-style-type: none"> ■ Vagy > 1 mm mélység (Heggesztés lehetséges) 		089073	
	<ul style="list-style-type: none"> ■ Vagy > 1 mm mélység (Heggesztés nem lehetséges) 	Zsaluhéj csere	Lásd tábl. (23.oldal)	
	29.08 Kalapács által okozott sérülések			
	<ul style="list-style-type: none"> ■ ≤ 1 mm mélység 			
	<ul style="list-style-type: none"> ■ Vagy > 1 mm mélység 	Zsaluhéj csere	Lásd tábl. (23 oldal)	

Zsaluhéj - felületi sérülések	Leírás	Instrukció	Fietési Kondíció	Típus
	29.09 Felületi karcolások <ul style="list-style-type: none"> ■ $T \leq 1$ mm mélység 			
	29.10 Mély karcolások <ul style="list-style-type: none"> ■ > 1 mm karcolás (heggesztés lehetséges) ■ Vagy > 1 mm karcolás (Heggesztés nem lehetséges) 			089073
	<ul style="list-style-type: none"> ■ Vagy > 1 mm karcolás (Heggesztés nem lehetséges) 	Zsaluhéj		Lásd tábl. (23 oldal)

Zsaluhéj - felületi sérülések	Leírás	Instrukció	Fietési Kondíció	Típus
-------------------------------	--------	------------	------------------	-------



29.11 Kidudorodott zsaluhéj, a tábla hátsó részéről törént ütés miatt (szemből nézve)

- $\varnothing \leq 3$ cm
- Vagy $\varnothing > 3$ cm



Hevítse a zsaluhéjat hőpisztollyal, utána üsse vissza a deformációt



Zsaluhéj csere



Lásd tábl. (23.oldal)



Kidudorodott zsaluhéj, a tábla hátsó részéről törént ütés miatt (hátról nézve)

Zsaluhéj - szerkezeti sérülések	Leírás	Instrukció	Fietési Kondíció	Típus
---------------------------------	--------	------------	------------------	-------



29.12 Törött zsaluhéj

- ≤ 10 cm hosszúság



089073



29.13 Törött zsaluhéj

- Vagy > 10 cm hosszúság
hegesztés nem lehetséges































Zsaluhéj cseré

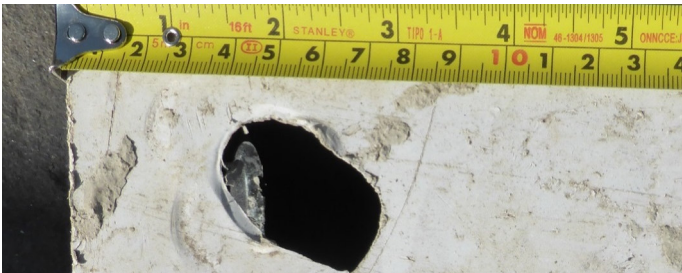

Lásd tábl.
(23 oldal)



Zsaluhéj - sérülés a széleken	Leírás	Instrukció	Fietési Kondíció	Típus
	<p>29.14 Enyhén ledörzsölt sérülés</p> <ul style="list-style-type: none"> ■ ≤ 5 mm szélesség 	<p>Szélek sorjázása kaparóval</p> 		
	<p>29.15 Erősen ledörzsölt sérülések</p> <ul style="list-style-type: none"> ■ > 5 mm szélesség hegesztés lehetséges 		 <p>089073</p>	
	<ul style="list-style-type: none"> ■ Vagy hegesztés nem lehetséges 	<p>Zsaluhéj csere</p> 	 <p>Lásd tábl. (23 oldal)</p>	

Zsaluhéj - szerkezeti sérülések	Leírás	Instrukció	Fietési Kondíció	Típus
	<p>29.16 Szegelt vagy fűrt lyukak</p> <ul style="list-style-type: none"> ■ $\leq \varnothing 5 \text{ mm}$ 			
	<p>29.17 Kis lyukak</p> <ul style="list-style-type: none"> ■ $\leq 1 \text{ cm}$ hegesztés lehetséges ■ Vagy hegesztés nem lehetséges 	  Zsaluhéj csere	 089073  Lásd tábl. (23 oldal)	 
	<p>29.18 Nagy lyukak</p> <ul style="list-style-type: none"> ■ $> 1 \text{ cm}$ hegesztés lehetséges ■ Vagy hegesztés nem lehetséges 	  Zsaluhéj csere	 089073  Lásd tábl. (23 oldal)	 

Zsaluhéj - sérülés a széleken	Leírás	Instrukció	Fizetési Kondíciók	Típus
-------------------------------	--------	------------	--------------------	-------



29.19 Bevágás a zsaluhéj szélén

- ≤ 1 cm hosszúság és ≤ 1 mm mélység



- Vagy > 1 cm hosszúság és > 1 mm mélység



089073



29.21 Zsaluhéj szélé teljesen kiszakadt

- ≤ 5 cm hosszúság és ≤ 1 cm mélység



089073



- Vagy > 5 cm hosszúság és > 1 cm mélység



Zsaluhéj csere

















Lásd tábl. (23 oldal)



PERI Bérleti kritériumok

DUO



Zsaluhéj - sérülés a széleken	Leírás	Instrukció	Fietési Kondíció	Típus
	29.22 Ledörzsölt sarok <ul style="list-style-type: none"> ■ ≤ 5 mm hosszúság 			
	<ul style="list-style-type: none"> ■ Vagy > 5 mm hosszúság 			089073 
	29.23 Sarok kiszakadt <ul style="list-style-type: none"> ■ ≤ 2 cm hosszúság 			
	<ul style="list-style-type: none"> ■ Vagy > 2 cm hosszúság 	 Zsaluhéj csere		Lásd tábl. (23 oldal) 

PERI Bérleti kritériumok

DUO



Zsaluhéj - hiányzó alkatrészek	Leírás	Instrukció	Fietési Kondíció	Típus
--------------------------------	--------	------------	------------------	-------

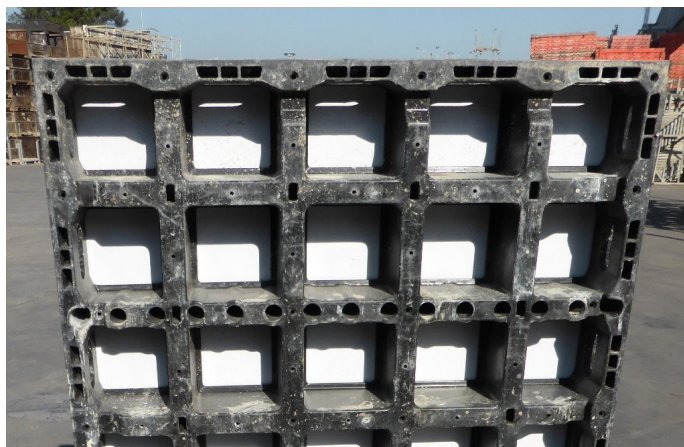

29.24 Hiányzó csavarok



29.25 Beton szennyezés, hiányzó csavarok miatt



Zsaluhéj ki-beszerelés



PERI Bérleti kritériumok

DUO



DUO tábla

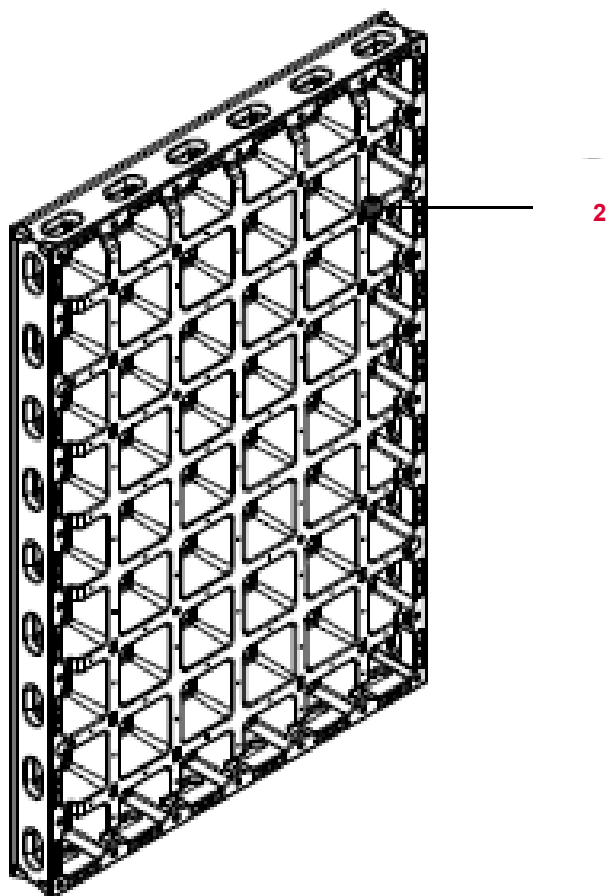

















No.	Név	Cikkszám
2	Tábla	Keretváz
	DP 135x90	128222
	DMP 135x75	128223
	DP 135x60	128224
	DMP 135x45	128225
	DP 135x30	128226
	DP 135x15	128227













Érvényes	Cikkszám
DUO Tábla DP 135 x 90	128280
DUO Tábla DMP 135 x 75	128281
DUO Tábla DP 135 x 60	128282
DUO Tábla DMP 135 x 45	128283
DUO Tábla DP 135 x 30	128284
DUO Tábla DP 135 x 15	128285

PERI Bérleti kritériumok

DUO











Keretváz - szennyeződés	Leírás	Instrukció	Fietési Kondíció	Típus
	29.26 Keretváz betonnal szennyezett	 Nagynyomású mosás	 089074	
	29.27 Keretváz rései betonnal feltöltődve	 Nagynyomású mosás vagy vésés	 089074	
	29.28 Fogantyúk betonnal feltöltődve	 Eltávolítás véséssel	 089074	
	29.29 Keretváz betonnal feltöltődve	 Nagynyomású mosás vagy vésés	 089074	













Keretváz - sérülés a széleken	Leírás	Instrukció	Fietési Kondíció	Típus	
	29.30 Keretváz sérülés a széleken				
	<ul style="list-style-type: none"> ■ ≤ 5 mm mélység ■ Vagy > 5 mm mélység 		Keretváz csere		Lásd tábl. (23. oldal)
	29.31 Keretváz sarok sérült				
	<ul style="list-style-type: none"> ■ ≤ 1 cm mélység ■ Vagy > 1 cm mélység 		Keretváz csere		Lásd tábl. (23. oldal)

PERI Bérleti kritériumok

DUO



Keretváz - fogantyú	Leírás	Instrukció	Fietési Kondíció	Típus
	29.32 Fogantyún repedés törés	 Keretváz csere	 Lásd tábl. (23.oldal)	
	29.33 Fogantyú kiszakadt	 Keretváz csere	 Lásd tábl. (23. oldal)	

Keretváz - bevágások	Leírás	Instrukció	Fietési Kondíció	Típus
	29.34 Alsó részen bevágás	 Keretváz csere	 Lásd tábl. (23. oldal)	
	29.35 Felső részen bevágás (zsaluhéj is)	 Keretváz csere	 Lásd tábl. (23. oldal)	
	29.36 Alsó rész kiszakadt	 Keretváz csere	 Lásd tábl. (23. oldal)	

Keretváz	Leírás	Instrukció	Fietési Kondíció	Típus
	29.37 Szegelt vagy fúrt lyukak <ul style="list-style-type: none"> ■ $\leq \varnothing 5 \text{ mm}$ 			
	<ul style="list-style-type: none"> ■ Vagy $> \varnothing 5 \text{ mm}$ (a megjelölt területen kívül, alsó kép) 	Keretváz csere	Lásd tábl. (23. oldal)	
	29.38 Nagy lyukak vagy törések a keretvázon <ul style="list-style-type: none"> ■ $\leq \varnothing 3 \text{ cm}$ a megjelölt területen (azonos magasságban a foggantyúval) 			
	<ul style="list-style-type: none"> ■ Vagy $> \varnothing 3 \text{ cm}$ a megjelölt területen 	Keretváz csere	Lásd tábl. (23. oldal)	
	<ul style="list-style-type: none"> ■ Vagy $> \varnothing 5 \text{ mm}$ a megjelölt területen kívül 	Keretváz csere	Lásd tábl. (23. oldal)	

PERI Bérleti kritériumok

DUO



Zsaluhéj és keretváz	Leírás	Instrukció	Fietési Kondíció	Típus
----------------------	--------	------------	------------------	-------



29.39 Átkötési lyuk kiszakadt



29.40 Tábla sarka kiszakadt



PERI Bérleti kritériumok

DUO



Cikk	Zsaluhéj		Keretváz	
	Pótalkatrész	Javítás cikkszama	Pótalkatrész	Javítás cikkszama
DUO Tábla DP 135 x 90	128228	084407	128222	089066
DUO Tábla DMP 135 x 75	128229	084408	128223	089067
DUO Tábla DP 135 x 60	128230	084409	128224	089068
DUO Tábla DMP 135 x 45	1238231	084410	128225	089069
DUO Tábla DP 135 x 30	128232	084411	128226	089070
DUO Tábla DP 135 x 15	128233	084412	128227	089071

PERI Bérleti kritériumok

DUO



Falbetétek	No.	Név	Cikkszám
------------	-----	-----	----------













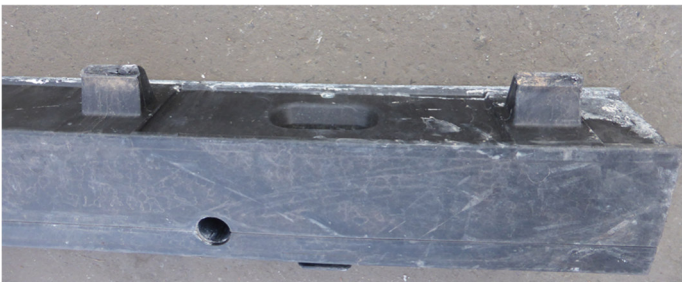

- | | |
|---|----------------------------|
| 1 | Kompenzációs héj DWC |
| 2 | Fog |
| 3 | Kompenzációs átkötési lyuk |

Érvényes	Cikkszám
DUO Falbetét DWC 135x10	128292
DUO Falbetét DWC 135x9	128291
DUO Falbetét DWC 135x8	128290
DUO Falbetét DWC 135x7	128289
DUO Falbetét DWC 135x6	128288
DUO Falbetét DWC 135x5	128287
DUO Falbetét DWC 60x5	129879
DUO Falbetét DWC 60x6	129880
DUO Falbetét DWC 60x7	129881
DUO Falbetét DWC 60x8	129883
DUO Falbetét DWC 60x9	129883
DUO Falbetét DWC 60x10	129884

PERI Bérleti kritériumok

DUO



Falbetét	Leírás	Instrukció	Fietési Kondíció	Típus
	29.41 Átkötés átvezető kiszakadt			
	29.42 Fog kiszakadt			
	29.43 Lyukak			

PERI Bérleti kritériumok

DUO



DUO kapocs (128247)	Leírás	Instrukció	Fizetési Kondíciók	Típus
---------------------	--------	------------	--------------------	-------



29.44 Széttört



29.69 Betonnal szennyezett



PERI Bérleti kritériumok

DUO



DUO heveder rögzítő (128293)

Leírás

Instrukció

Fizetési Kondíciók

Típus



29.45 Heveder rögzítő fül leszakadt



29.70 Betonnal szennyezett



PERI Bérleti kritériumok

DUO



DUO támaszkapcsoló (128294)	Leírás	Instrukció	Fietési Kondíció	Típus
-----------------------------	--------	------------	------------------	-------



29.46 Rögzítő szem eltört



29.47 Kötőcsavar selejt



128254



089072



PERI Bérleti kritériumok

DUO



DUO daruhorog (128296)	Leírás	Instrukció	Fizetési Kondíciók	Típus
------------------------	--------	------------	--------------------	-------

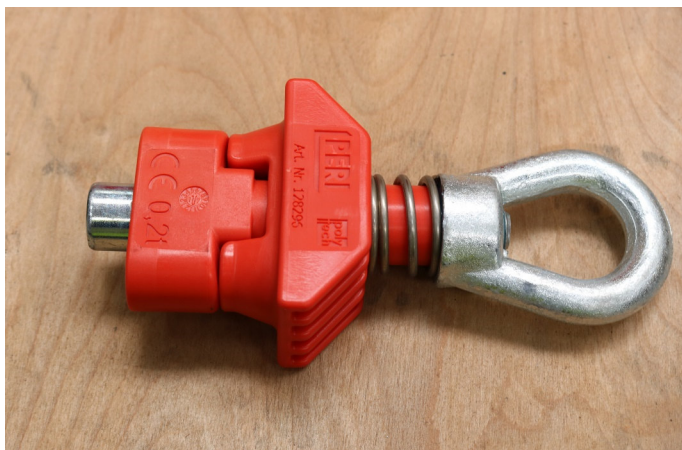

29.48 Kiszakadt alkatrészek vagy funkcionálisan nem működik (a képen lévő anyagon nincs sérülés)



PERI Bérleti kritériumok

DUO



DUO betonozó konzol(128257)	Leírás	Instrukció	Fietési Kondíció	Típus
-----------------------------	--------	------------	------------------	-------



29.49 Első verzió ,teljesen technopolymerből készült (ez a verzió kivezetésre került! A 2. verzióval helyettesíthető)

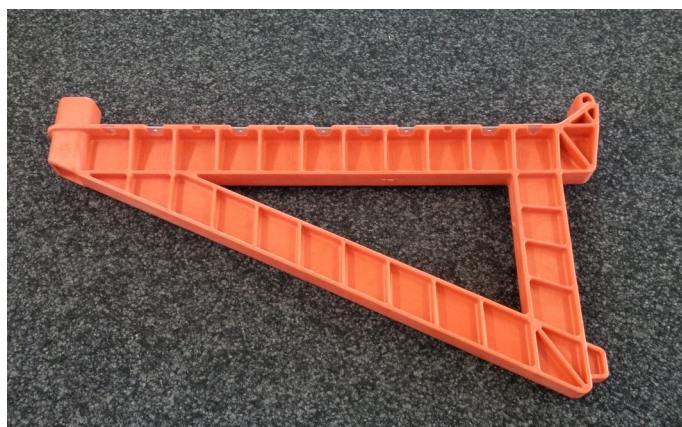

29.50 Második verzió, technopolymer konzol , acél megerősítéssel



PERI Bérleti kritériumok

DUO



DUO betonozó konzol (128257)	Leírás	Instrukció	Fizetési Kondíciók	Típus
------------------------------	--------	------------	--------------------	-------



29.71 Eltört



29.72 Betonnal szennyezett



PERI Bérleti kritériumok

DUO



DUO kiegyenlítő heveder 62(128255)	Leírás	Instrukció	Fizetési Kondíciók	Típus
------------------------------------	--------	------------	--------------------	-------



29.51 A közepén eltört



29.73 A végein eltört



PERI Bérleti kritériumok

DUO



<u>DUO tábla magasztó (129809; 128710; 129811)</u>	Leírás	Instrukció	Fizetési Kondíciók	Típus
--	--------	------------	--------------------	-------



29.52 Darabok kitörtek

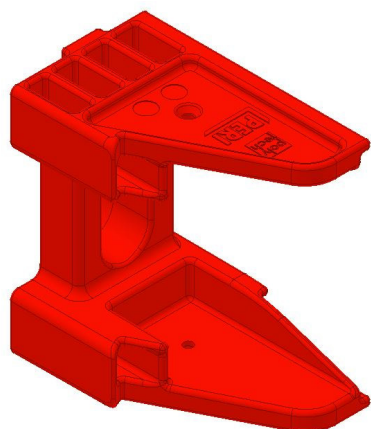

29.53 Repedés az anyanyagban











- > 3 mm mély



PERI Bérleti kritériumok

DUO



DUO kötőcsavar (128256)	Leírás	Instrukció	Fizetési Kondíciók	Típus
	29.54 Menet <ul style="list-style-type: none">■ Kopott■ Vagy erő hatására sérült	 	 	 
	29.55 Darabok kitörtek			

PERI Bérleti kritériumok

DUO



DUO sarok DC (128286; 129864)	Leírás	Instrukció	Fizetési Kondíciók	Típus
-------------------------------	--------	------------	--------------------	-------



29.56 Darabok kitörtek



29.57 Fog kitört



PERI Bérleti kritériumok

DUO



DUO támaszfej DFH (128298; 129862)	Leírás	Instrukció	Fizetési Kondíciók	Típus
------------------------------------	--------	------------	--------------------	-------



29.58 Karcolások | Repedések

- ≤ 5 mm mélység
- Vagy > 5 mm mélység



29.59 Darabok kitörtek | Lyukak az anyagban



PERI Bérleti kritériumok

DUO



DUO támaszfej DFH (128298; 129862)	Leírás	Instrukció	Fizetési Kondíciók	Típus
------------------------------------	--------	------------	--------------------	-------

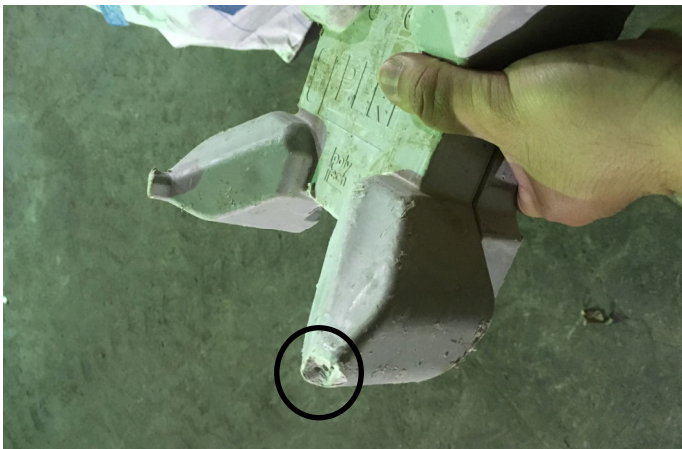

29.60 Fül letört

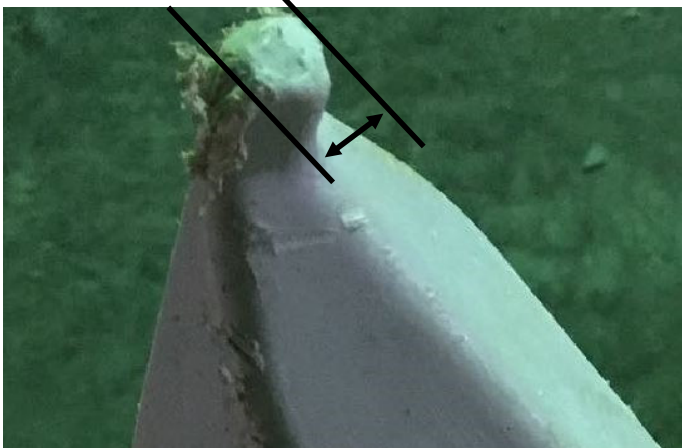

29.61 Fül kopott

- Távolság < 5 mm



PERI Bérleti kritériumok

DUO



DUO korlátozó tartó (128297)	Leírás	Instrukció	Fizetési Kondíciók	Típus
------------------------------	--------	------------	--------------------	-------



29.63 Darabok kitörtek



29.64 Repedések az anyagban









- > 3 mm mélység

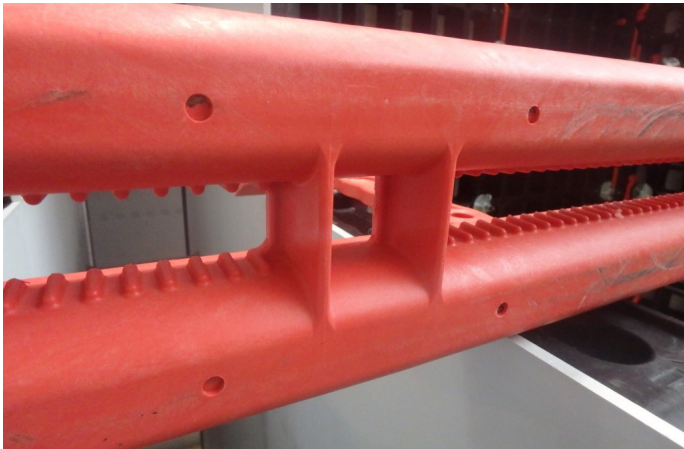

PERI Bérleti kritériumok

DUO



DUO kiegyenlítő heveder 82 (128263)	Leírás	Instrukció	Fizetési Kondíciók	Típus
	29.65 Fog <ul style="list-style-type: none"> <li data-bbox="875 568 987 592">■ Elkopott <li data-bbox="875 711 1021 735">■ Vagy letört 			
	29.66 Darabok kitörtek			

PERI Bérleti kritériumok

DUO



DUO horgony kapocs (129976)	Leírás	Instrukció	Fizetési Kondíciók	Típus
-----------------------------	--------	------------	--------------------	-------

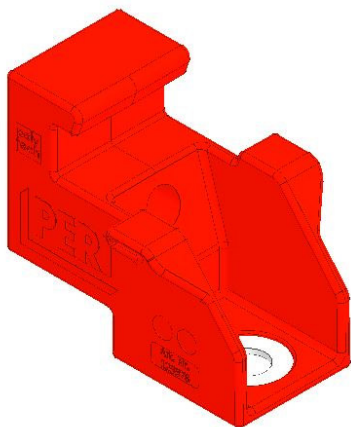

29.67 Darabok kitörtek

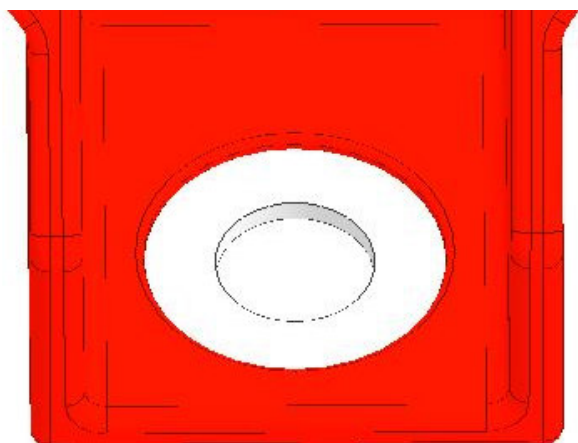

29.68 A kerettartó betéte
repedt | törött



PERI Bérleti kritériumok

DUO



DUO födém fogasléc (131061)	Leírás	Instrukció	Fizetési Kondíciók	Típus
-----------------------------	--------	------------	--------------------	-------



29.74 Fog letört

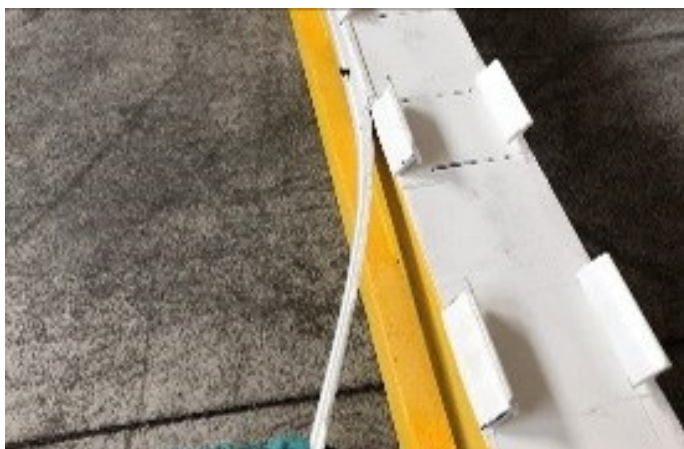

29.75 Szegély leszakadt

■ ≤ 300 mm hosszúság



■ Vagy > 300 mm hosszúság



PERI Bérleti kritériumok

DUO



DUO álvány fejadapter (131139)	Leírás	Instrukció	Fizetési Kondíciók	Típus
--------------------------------	--------	------------	--------------------	-------

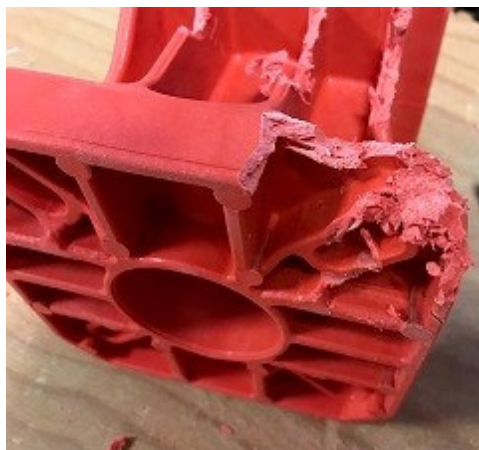

29.76 Darabok kitörtek



29.77 Belső perem sérült

■ Funkcionálisan működik



■ Vagy nem működik



PERI Bérleti kritériumok

DUO



DUO korlátozlop tartó-2 (131242)	Leírás	Instrukció	Fizetési Kondíciók	Típus
----------------------------------	--------	------------	--------------------	-------



29.78 Repedések a horgonyterületen



















29.79 Koláttartó rész sérült



PERI Bérleti kritériumok

Ikonok



Ikon	Jelentés	Ikon	Jelentés	Ikon	Jelentés
	Nem OK — kicselezendő		Ügyfélnek leszámházandó		Optikai kár
	OK– marad a bérleti parkban		Nincs számlázás		Funkcionális sérülés
	Selejt anyag – biztonsági okokból az anyagot tilos kiadni		Anyagot levágni		Funkcionális sérülés — anyag kiadása nem engedélyezett
	Javítás az előírások szerint		Anyagot megjelölni		Statikai sérülés — anyag kiadása nem engedélyezett
	Hideg egyengetés — utána a varratokat és a környékét ellenőrzni kell		Sérült anyag cseréje		
	Javítás gazdaságosság függvényében		Hiányzó anyag cseréje		
	Megtisztítani az anyagot				