

# PERI Bérleti kritériumok

## PEP Födém támaszok



### Kapcsolat

**PERI Kft**  
**Zsaluzatok, állványzatok,**  
**mérnöki szolgáltatás**

H-1180 Budapest  
Zádor u. 9.  
Tel.: +36-1-296-09-60  
[www.peri.hu](http://www.peri.hu)

Tartalom	Oldal
Támasz PEP Ergo	2
Támasz PEP 20, 30	8
Kiegészítők	13
Magyarázat	26

Változtatások	Dátum   ü	Oldal
Új verzió	09/2015   Sz.L.	

# PERI Bérleti kritériumok

## PEP Födém támaszok



### PEP ERGO támasz

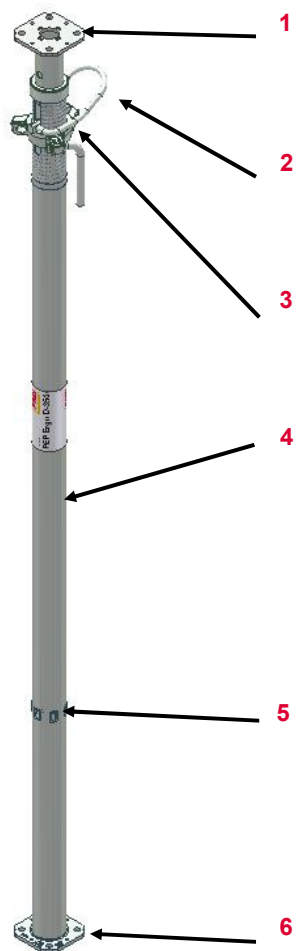











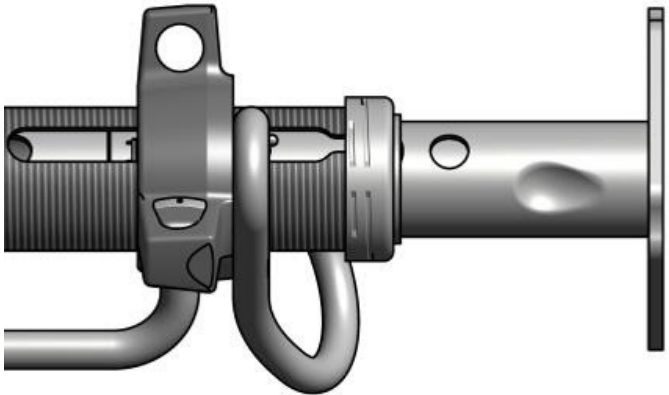

Sorszám	Megnevezés	Cikkszám
1	Fejlemez	
2	G- horog	
3	Állító anya	
4	Külső cső	
5	Bélyegzés	
6	Talplemez	

Megnevezés	Cikkszám
Támasz PEP ERGO B-300	116780
Támasz PEP ERGO B-350	116790
Támasz PEP ERGO D-150	117230
Támasz PEP ERGO D-250	116770
Támasz PEP ERGO D-350	125130
Támasz PEP ERGO D-400	125140
Támasz PEP ERGO D-500	125150
Támasz PEP ERGO E-300	125160
Támasz PEP ERGO E-400	125170

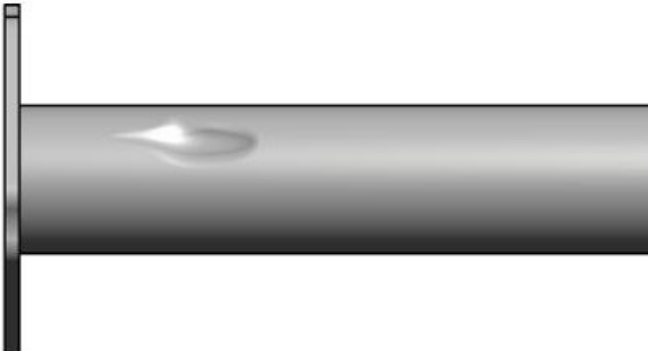
# PERI Bérleti kritériumok

## PEP Födém támaszok



PEP Ergo támasz	Leírás	Instrukció	Fizetési kondíciók	Típus
	<b>Horpadt belső cső</b> <ul style="list-style-type: none"> <li>■ Belső cső nem mozgatható</li> </ul>	 Belső cső csere	 Lásd táblázat (o. 4)	
	<ul style="list-style-type: none"> <li>■ Vagy a horpadás mélysége &gt; 7 mm</li> </ul>	 Belső cső csere	 Lásd táblázat (o. 4)	
	<b>Horpadt külső cső</b> <ul style="list-style-type: none"> <li>■ Belső cső nem mozgatható</li> </ul>	 Külső cső csere	 088249	
	<ul style="list-style-type: none"> <li>■ Vagy a horpadás mélysége &gt; 7 mm</li> </ul>	 Külső cső csere	 Lásd táblázat (o. 4)	

# PERI Bérleti kritériumok

## PEP Födém támaszok





Termék	Belső cső csere		Külső cső csere	
	Cikkszám.– alkatrész	Szervíz cikkszám	Cikkszám.– alkatrész	Szervíz cikkszám
PEP ERGO B-300	116786	088719	116788	088710
PEP ERGO B-350	116794	088720	116769	088711
PEP ERGO D-150	117226	088721	117228	088712
PEP ERGO D-250	116778	088722	116789	088713
PEP ERGO D-350	125543	088723	125546	088714
PEP ERGO D-400	125562	088724	125565	088715
PEP ERGO D-500	125581	088725	125584	088716
PEP ERGO E-300	125588	088726	125591	088717
PEP ERGO E-400	125595	088727	125598	088718

# PERI Bérleti kritériumok

## PEP Födém támaszok

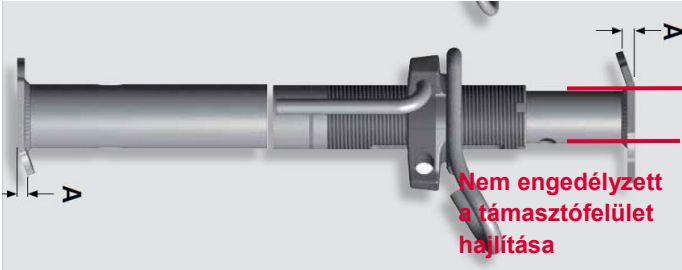

















Sérülés   támasz	Leírás	Instrukció	Fizetési kondíciók	Típus
 <p>Nem engedélyezett a támasztófelület hajlítása</p>	<p><b>Talp vagy fejlemez hajlott</b></p> <ul style="list-style-type: none"> <li>■ &gt; 10 mm</li> </ul>		088249	
	<p><b>Állító anya</b></p> <ul style="list-style-type: none"> <li>■ Menet megszakadt</li> </ul>		088235	
	<ul style="list-style-type: none"> <li>■ Vagy repedés a beállítóanyán</li> </ul>		088235	
	<p><b>G- Horog</b></p> <ul style="list-style-type: none"> <li>■ Hiányzik</li> </ul>		088247	
	<ul style="list-style-type: none"> <li>■ Vagy nem megfelelően funkcionál</li> </ul>		088247	

# PERI Bérleti kritériumok

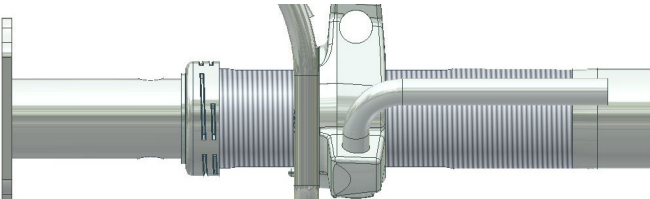
## PEP Födém támaszok



Támasz	Leírás	Instrukció	Fizetési kondíciók	Típus
	Repedés a hegesztésben			
	Az ütközőcsavar meglazult/hiányzik			
	A támasz csöve meg lett melegítve			
	Olaj vagy zsír a menetnél			

# PERI Bérleti kritériumok

## PEP Födém támaszok



Támasz	Leírás	Instrukció	Fizetési kondíciók	Típus
	Vágott fej- vagy talplemez	 Külső vagy belső cső		

# PERI Bérleti kritériumok

## PEP Födém támaszok



### PEP 20, 30 támaszok

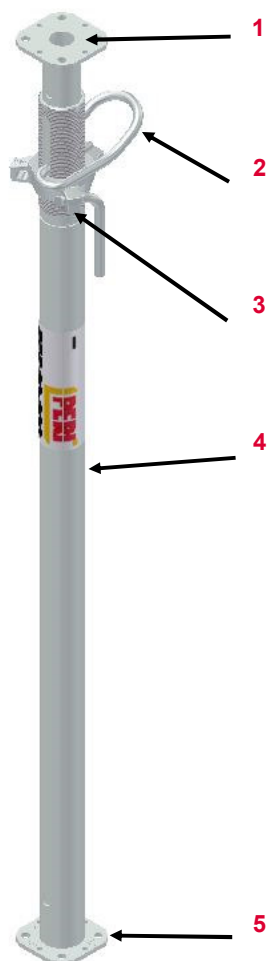

Sorszám	Megnevezés	Cikkszám
---------	------------	----------

1 Fejlemez

2 G- horog

3 Állító anya

4 Külső cső

5 Talplemez

Megnevezés	Cikkszám
------------	----------

Támasz PEP 20-300 103058

Támasz PEP 20-350 103059

Támasz PEP 20-400 103060

Támasz PEP 20-500 103061

Támasz PEP 30-150 103066

Támasz PEP 30-250 103067

Támasz PEP 30-300 103062

Támasz PEP 30-350 103063









Támasz PEP 30-400 103065

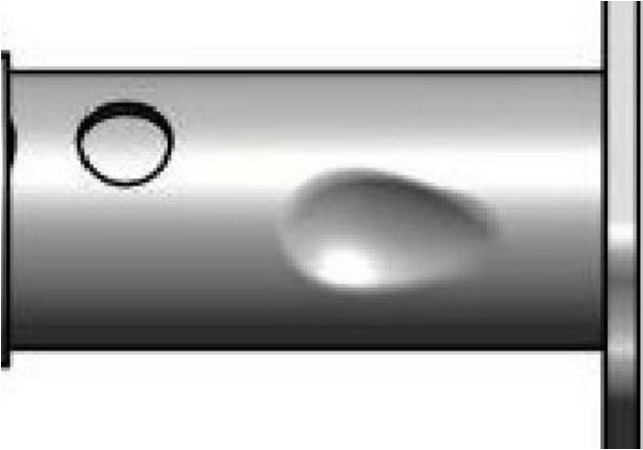

# PERI Bérleti kritériumok

## PEP Födém támaszok



Támasz	Leírás	Instrukció	Fizetési kondíciók	Típus
	<b>Horpadás a belső csövön</b> <ul style="list-style-type: none"><li>■ Belső cső nem mozgatható</li></ul>			
	<b>Horpadás a külső csövön</b> <ul style="list-style-type: none"><li>■ Belső cső nem mozgatható</li></ul>		 088249	

# PERI Bérleti kritériumok

## PEP Födém támaszok











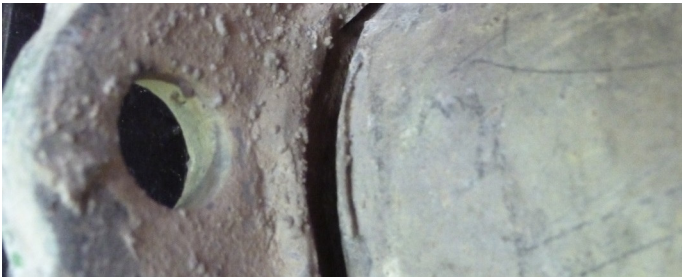



Támasz	Leírás	Instrukció	Fizetési kondíciók	Típus
	<p><b>Talp- vagy fejlemez deformálódott</b></p> <ul style="list-style-type: none"> <li>■ &gt; 10 mm</li> </ul>		088249	
	<p><b>Állító anya</b></p> <ul style="list-style-type: none"> <li>■ Menet megszakadt</li> </ul>			
	<ul style="list-style-type: none"> <li>■ Vagy repedés az anyagában</li> </ul>			
	<p><b>G- Horog</b></p> <ul style="list-style-type: none"> <li>■ Hiányzik</li> </ul>		088247	
	<ul style="list-style-type: none"> <li>■ Vagy nem funkcionál</li> </ul>		088247	

# PERI Bérleti kritériumok

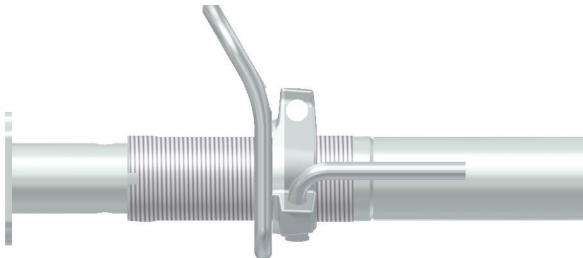
## PEP Födém támaszok



Támasz	Leírás	Instrukció	Fizetési kondíciók	Típus
	Repedés a hegesztésben			
	Támasz csöve meg lett melegítve			
	Olaj vagy zsír a menetnél			

# PERI Bérleti kritériumok

## PEP Födém támaszok

















Támasz	Leírás	Instrukció	Fizetési kondíciók	Típus
	Vágott fej- vagy talplemez			

# PERI Bérleti kritériumok

## PEP Födém támaszok



Háromláb (107152)	Leírás	Instrukció	Fizetési kondíciók	Típus
	<b>Lábak meghajlottak</b> <ul style="list-style-type: none"> <li>■ ≤ 10 mm</li> </ul>		 088244	
	<ul style="list-style-type: none"> <li>■ &gt; 10 mm</li> </ul>			
 <p>Névleges méret 70mm</p>	<b>Hajlott rögzítőfűl</b> <ul style="list-style-type: none"> <li>■ ≤ 3 mm hajlás</li> </ul>			
	<ul style="list-style-type: none"> <li>■ &gt; 3 mm hajlás</li> </ul>		 088244	

# PERI Bérleti kritériumok

## PEP Födém támaszok



### Háromláb univerzális (028000)

Sorszám      Megnevezés      Cikkszám



1	Forgókar	715643
2	Rögzítő horog	710161
3	Bütykös anya	030130
4	Támasztóláb	715642

# PERI Bérleti kritériumok

## PEP Födém támaszok











Univerzális háromláb	Leírás	Instrukció	Fizetési kondíciók	Típus
	<p><b>Forgó kar elgörbült</b></p> <ul style="list-style-type: none"> <li>■ Ha lehetséges</li> <li>■ Vagy ha nem lehetséges</li> </ul>	<ul style="list-style-type: none"> <li> 088244</li> <li> 715643 (Forgó kar)</li> </ul>	<ul style="list-style-type: none"> <li> 088244</li> <li> 089149</li> </ul>	<ul style="list-style-type: none"> <li></li> <li></li> </ul>
	<p><b>Támasztóláb elgörbült</b></p> <ul style="list-style-type: none"> <li>■ Ha lehetséges</li> <li>■ Vagy ha nem lehetséges</li> </ul>	<ul style="list-style-type: none"> <li> 088244</li> <li></li> </ul>	<ul style="list-style-type: none"> <li> 088244</li> <li></li> </ul>	<ul style="list-style-type: none"> <li></li> <li></li> </ul>



# PERI Bérleti kritériumok

## PEP Födém támaszok



Univerzális háromláb	Leírás	Instrukció	Fizetési kondíciók	Típus
	<p>Rögzítő horog deformálódása</p> <ul style="list-style-type: none"><li>■ &gt; 100°</li></ul>		 088920	
	<p>A bütykös anya rongálódott</p>	 030130 (Bütykös anya) 767043 (Szegecs)	 088429	



# PERI Bérleti kritériumok

## PEP Födém támaszok



PEP Keret PRK	Sorszám	Megnevezés	Cikkszám
---------------	---------	------------	----------

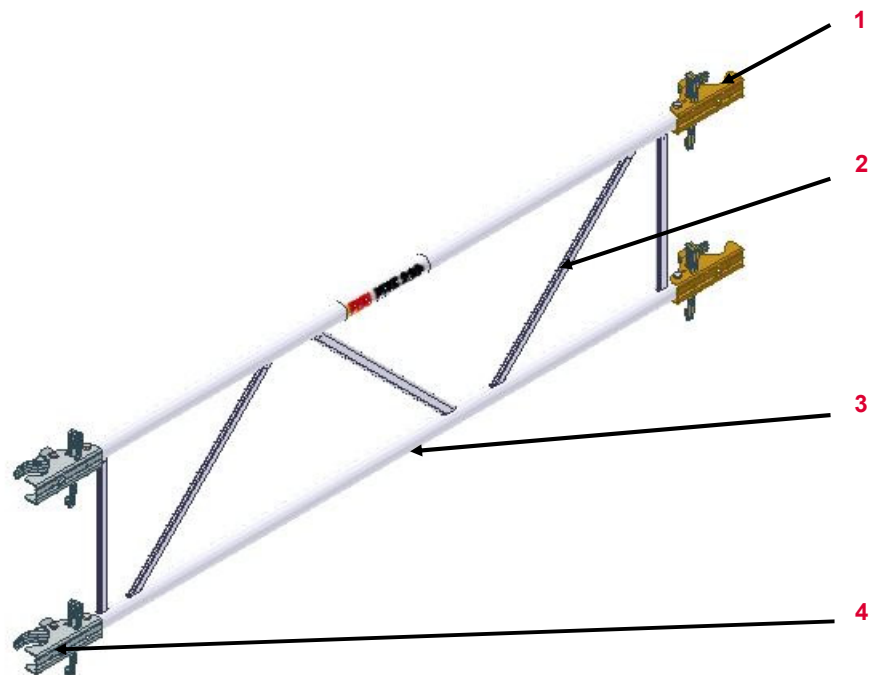

1	Csatlakozó PRK bal	112210
2	Átlós merevítő	
3	Keret	
4	Csatlakozó PRK jobb	112206

Megnevezés	Cikkszám
Keret PRK 62,5	111811
Keret PRK 75	111812
Keret PRK 100	112813
Keret PRK 120	112814
Keret PRK 137,5	111815
Keret PRK 150	111814
Keret PRK 180	115980
Keret PRK 200	112718
Keret PRK 201,5	111815
Keret PRK 210	112788
Keret PRK 225	111816
Keret PRK 230	111817
Keret PRK 266	111818
Keret PRK 296	111819

# PERI Bérleti kritériumok

## PEP Födém támaszok



PEP Keret PRK	Leírás	Instrukció	Fizetési kondíciók	Típus
---------------	--------	------------	--------------------	-------

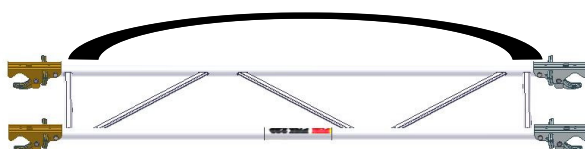

### Keret görbült

■  $\leq$  megengedett görbületnél



■ Vagy  $>$  megengedett hajlítás











Cikk	Megeng.
PRK 62,5	3,0 mm
PRK 75	3,0 mm
PRK 100	3,0 mm
PRK 120	3,0 mm
PRK 137,5	3,0 mm
PRK 150	3,0 mm
PRK 180	3,6 mm
PRK 200	4,0 mm
PRK 201,5	4,0 mm
PRK 210	4,2 mm
PRK 225	4,5 mm
PRK 230	4,7 mm
PRK 266	5,3 mm
PRK 296	5,9 mm

# PERI Bérleti kritériumok

## PEP Födém támaszok



















PEP Keret PRK	Leírás	Instrukció	Fizetési kondíciók	Típus
	Csatlakozó bal / jobb elhasznált / deformálódott	 112210 (Csatlakozó bal) 112206 (Csatlakozó jobb)	 088246	
	A hegesztésben repedés a merevítőnél			

# PERI Bérleti kritériumok

## PEP Födém támaszok



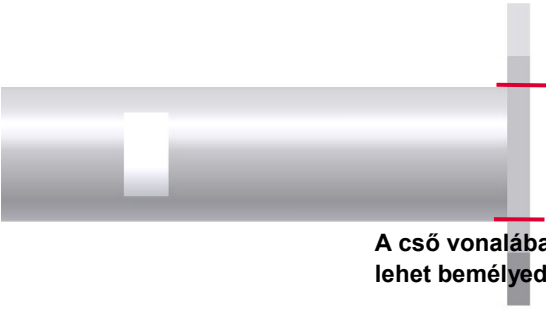













Multiprop MP 50 támasztoldó (027310)	Leírás	Instrukció	Fizetési kondíciók	Típus	
	<b>Horpadás a csövön</b> <ul style="list-style-type: none"> <li>■ <math>\leq 6</math> mm mélység és <math>\leq \varnothing 60</math> mm</li> <li>■ Vagy <math>&gt; 6</math> mm mély</li> <li>■ Vagy <math>&gt; \varnothing 60</math> mm</li> </ul>	  	  	  	
	<b>Fej és talplemez deformálódott</b> <ul style="list-style-type: none"> <li>■ <math>\leq 15</math> mm</li> <li>■ Vagy <math>&gt; 15</math> mm</li> </ul>	 	 	088244 	 
	 <p>A cső vonalában nem lehet bemélyedés</p>				

# PERI Bérleti kritériumok

## PEP Födém támaszok











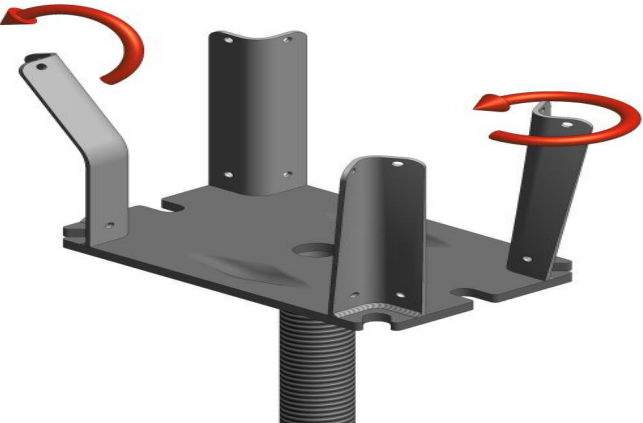





Talp MP 50 (027310)	Leírás	Instrukció	Fizetési kondíciók	Típus
	<b>A rugós cső hiányzik vagy sérült</b>			
	<ul style="list-style-type: none"> <li>■ Rugós cső első verzió (fekete)</li> <li>■ Rugós cső második verzió (narancs)</li> </ul>	 	 088367 	 
	<b>A feszítő karom hiányzik vagy sérült</b>			
		780108 (rugós cső) 780105 (feszítő karom) 710381 (anya) 780702 (mosás 2x)	088367 088368 088369	
	<b>A feszítő karom nincs meghúzva</b>			
	<ul style="list-style-type: none"> <li>■ A feszítő karomnak ellenálással kell rendelkeznie, mikor kézzel mozgatják</li> </ul>			

# PERI Bérleti kritériumok

## PEP Födém támaszok



MF keresztfej 20/24 (027890)	Leírás	Instrukció	Fizetési kondíciók	Típus
	<p><b>Vezető támasztó fül</b></p> <ul style="list-style-type: none"> <li>■ Hajlott (hegesztés sérülése nélkül)</li> <li>■ Vagy hajlott (hegesztés sérülésével)</li> <li>■ Vagy hiányzik</li> </ul>	<ul style="list-style-type: none"> <li></li> <li></li> <li></li> </ul>	<ul style="list-style-type: none"> <li> 088395</li> <li> 088394</li> <li> 088394</li> </ul>	<ul style="list-style-type: none"> <li></li> <li></li> <li></li> </ul>
	<p><b>Alaplap</b></p> <ul style="list-style-type: none"> <li>■ &gt; 5 mm</li> </ul>	<ul style="list-style-type: none"> <li></li> </ul>	<ul style="list-style-type: none"> <li></li> </ul>	<ul style="list-style-type: none"> <li></li> </ul>

# PERI Bérleti kritériumok

## PEP Födém támaszok



Keresztfej 20/24   S (027890   028680)	Leírás	Instrukció	Fizetési kondíciók	Típus
--	--------	------------	--------------------	-------



Hegesztett fogantyú (nem standard hegesztés)











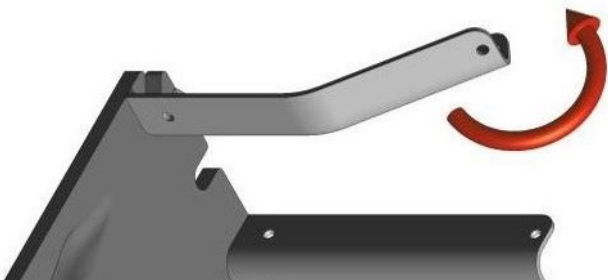











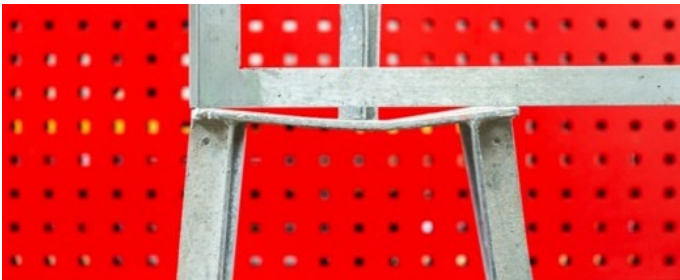

# PERI Bérleti kritériumok

## PEP Födém támaszok



Keresztfel 20/24S (028680)	Leírás	Instrukció	Fizetési kondíció	Típus
	<p><b>Vezető támasztó fül</b></p> <ul style="list-style-type: none"> <li>■ Deformálódott (hegesztés sérülése nélkül)</li> <li>■ Vagy deformálódott (sérülés a hegesztésben)</li> <li>■ Vagy hiányzik</li> </ul>	    	 088395  088394  088394	  
	<p><b>Deformálódott alaplap</b></p> <ul style="list-style-type: none"> <li>■ &gt; 5 mm</li> </ul>	 		
	<p><b>Biztonsági nyílás</b></p>		 088898	



# PERI Bérleti kritériumok

## PEP Födém támaszok



Palló szorító (027940; 027790)	Sorszám	Megnevezés	Cikkszám
--------------------------------	---------	------------	----------

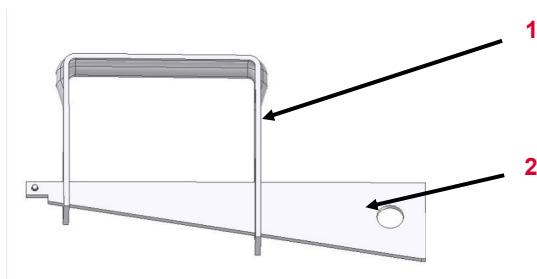

1	Konzol
2	Ék

Sérülés	Leírás	Instrukció	Fizetési kondíciók	Típus
---------	--------	------------	--------------------	-------

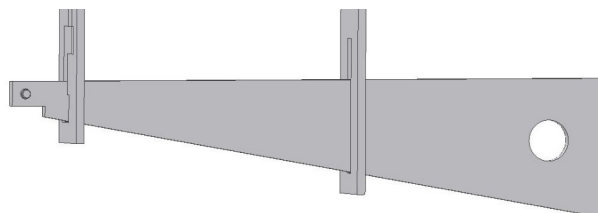

Ék hiányzik

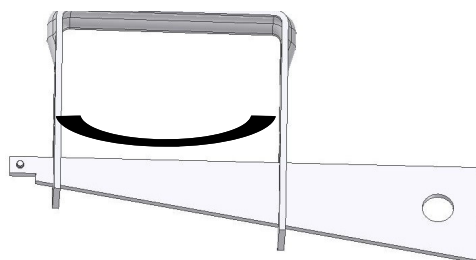

Konzol elgörbült



















088244



# PERI Bérleti kritériumok

## Magyarázat



Ikon	Jelentése	Ikon	Jelentése	Ikon	Jelentése
	Nem OK — kicselezendő		Ügyfélnek leszámházandó		Optikai kár
	OK– marad a bérleti parkban		Nincs számlázás		Funkcionális sérülés
	Selejt anyag – biztonsági okokból az anyagot tilos kiadni		Anyagot levágni		Funkcionális kár– anyag kiadása nem engedélyezett
	Javítás az előírások szerint		Anyagot megjelölni		Statikai sérülés — anyag kiadása nem engedélyezett
	Hideg egyengetés — utána a varratokat és a környékét ellenőrzni kell		Sérült anyag cseréje		
	Javítás gazdaságosság függvényében		Hiányzó anyag pótlása		
	Megtisztítani az anyagot				