

# PERI Bérleti kritériumok

## PERI UP lépcsők



### Kapcsolat

**PERI kft,**  
**zsálatok, állványzatok,**  
**mérnöki szolgáltatás**

H-1181 Budapest  
Zádor u. 9.  
Tel.: +36-1-296-09-60  
[www.peri.hu](http://www.peri.hu)

Tartalom	oldal
Lépcső	2
Lépcsőfokok	9
Lépcsőkar gerenda	12
Korlátok	15
Korláttartó   Végkorláttartó	20
Vízszintes heveder UHP Public	22
Pihenő merevítő	26
Acél járóta	27
Magyarázat	35

Változtatások	Dátum   ü	oldal
Új verzió	08/2021   O.L.	

# PERI Bérleti kritériumok

## PERI UP lépcsők



### UP állványlépcső UAS

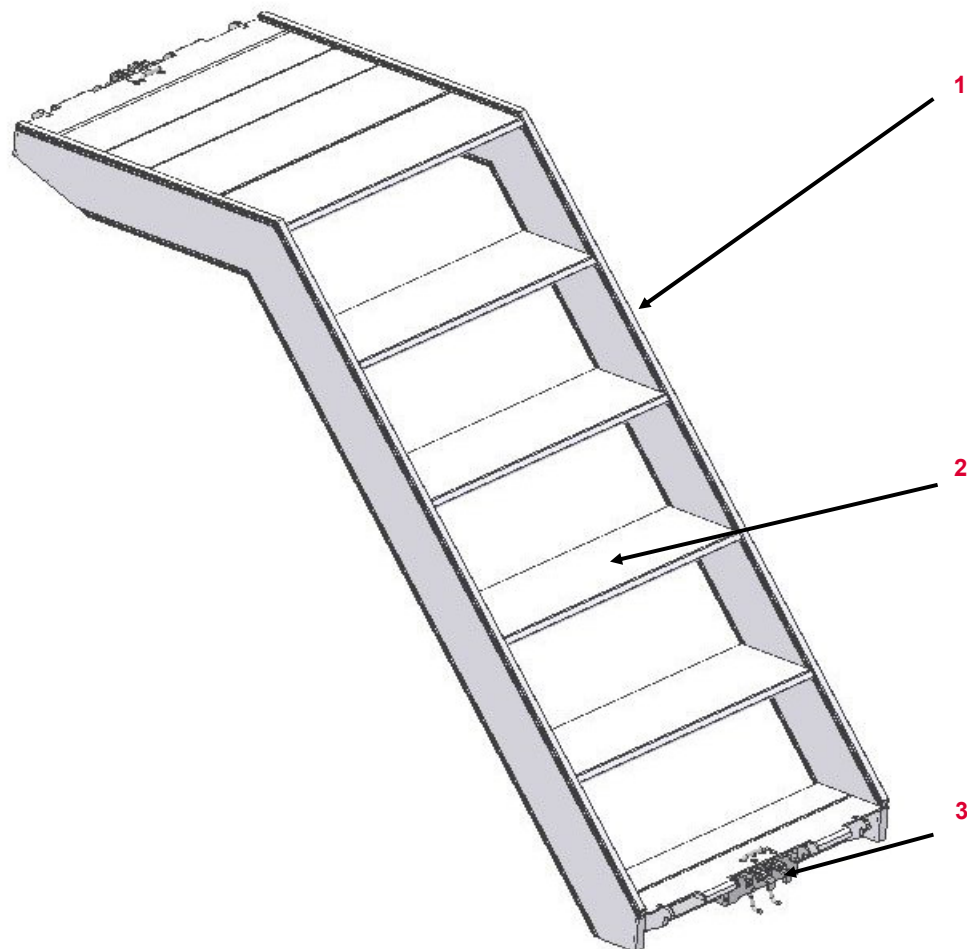

Sorszám	Megnevezés	Cikkszám
1	Oldal profil	
2	Lépcsőfok	
3	Kapcsoló fülek	

Megnevezés	Cikkszám
UP állványlépcső UAS 250/200	100737
UP állványlépcső UAS 300/200	100738
UP állványlépcső UAS 75x75/50	113228
UP állványlépcső UAS 75x150/50 T	111087
UP állványlépcső UAS 75x150/50 S	111095
UP állványlépcső UAS 75x150/100 T	111103
UP állványlépcső UAS 75x150/100 S	114536
UP állványlépcső UAS 75x250/200	111117
UP állványlépcső UAS 75x300/200	111124

# PERI Bérleti kritériumok

## PERI UP lépcsők



UP állványlépcső UAS	Leírás	Instrukció	Fizetési kondíciók	Típus
----------------------	--------	------------	--------------------	-------



### Repedés a hegesztés mellett

■ < 20 mm



■ > 20 mm











### Repedés a hegesztésben

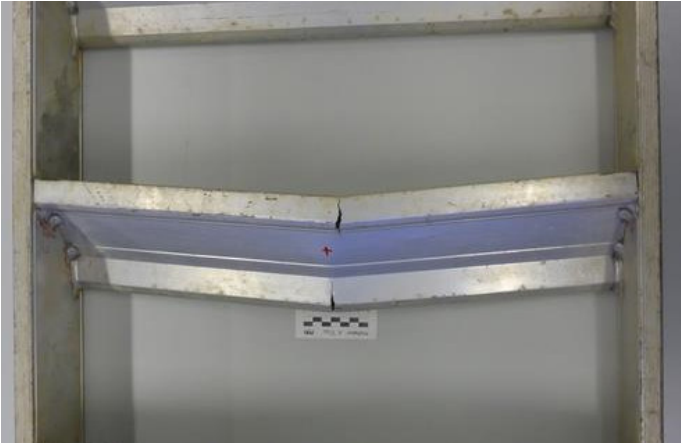

# PERI Bérleti kritériumok

## PERI UP lépcsők



UP állványlépcső UAS	Leírás	Instrukció	Fizetési kondíciók	Típus
	Repedés az anyagban (lépcsőfok kitört)			
	Lépcsőfok repedt / megtört			



# PERI Bérleti kritériumok

## PERI UP lépcsők













UP állványlépcső UAS	Leírás	Instrukció	Fizetési kondíciók	Típus
	<p><b>Deformáció a lépcső elején vagy végén</b></p>			
	<p><b>Horpadás az oldalprofilon</b></p> <ul style="list-style-type: none"> <li>■ Anyag vagy hegesztés repedése nélkül</li> <li>■ Repedés az anyagban / hegesztésben vagy éleket érintő horpadás esetén</li> </ul>	 	 	 

# PERI Bérleti kritériumok

## PERI UP lépcsők



UP állványlépcső UAS	Leírás	Instrukció	Fizetési kondíciók	Típus
	<p><b>Repedés a kapcsoló fülben</b></p>			
	<p><b>Kapcsoló fül elgörbült</b></p> <ul style="list-style-type: none"> <li>■ Repedés nélkül és görbület <math>\leq 5</math> mm</li> <li>■ Görbület <math>&gt; 5</math> mm</li> </ul>	<p>■ Repedés nélkül és görbület <math>\leq 5</math> mm</p>  <p>■ Görbület <math>&gt; 5</math> mm</p> 	<p>■ Repedés nélkül és görbület <math>\leq 5</math> mm</p>  <p>■ Görbület <math>&gt; 5</math> mm</p> 	<p>■ Repedés nélkül és görbület <math>\leq 5</math> mm</p>  <p>■ Görbület <math>&gt; 5</math> mm</p> 

# PERI Bérleti kritériumok

## PERI UP lépcsők



UP állványlépcső UAS	Leírás	Instrukció	Fizetési kondíciók	Típus
	<p><b>Karom elgörbült</b></p> <ul style="list-style-type: none"><li>■ Repedés nélkül és görbület <math>\leq 5</math> mm</li><li>■ Görbület <math>&gt; 5</math> mm</li></ul>	<p>■ </p> <p>■ </p>	<p>■ </p> <p>■ </p>	<p>■ </p> <p>■ </p>

# PERI Bérleti kritériumok

## PERI UP lépcsők



UP lépcsőkar gerenda UA (114731   109219)	Leírás	Instrukció	Fizetési kondíciók	Típus
	<b>Csatlakozó deformálódott</b>	<ul style="list-style-type: none"> <li>■ Ha lehetséges</li> </ul>		
	<ul style="list-style-type: none"> <li>■ Ha nem lehetséges</li> </ul>			
	<ul style="list-style-type: none"> <li>■ Ha eltört</li> </ul>			
	<b>Horpadás a profilon</b>	<ul style="list-style-type: none"> <li>■ <math>\leq \varnothing 3</math> cm És az éleket nem érinti</li> </ul>		
	<ul style="list-style-type: none"> <li>■ Vagy <math>&gt; \varnothing 3</math> cm</li> </ul>			
	<ul style="list-style-type: none"> <li>■ Vagy az éleket érinti</li> </ul>			

# PERI Bérleti kritériumok

## PERI UP lépcsők



### UP lépcsők

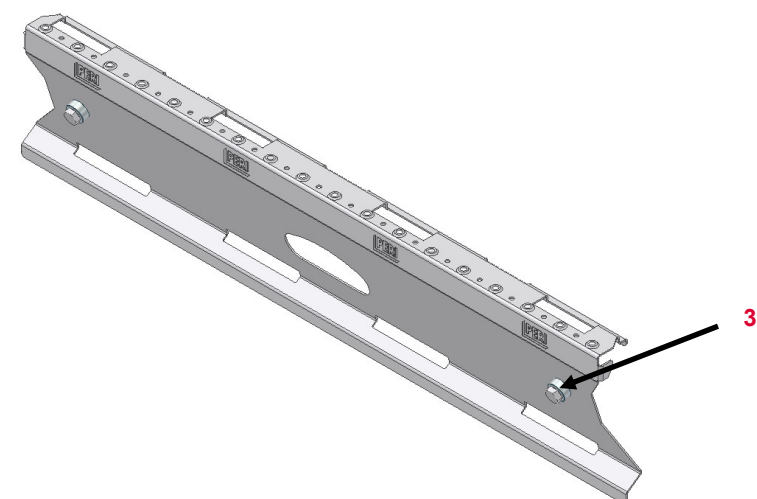
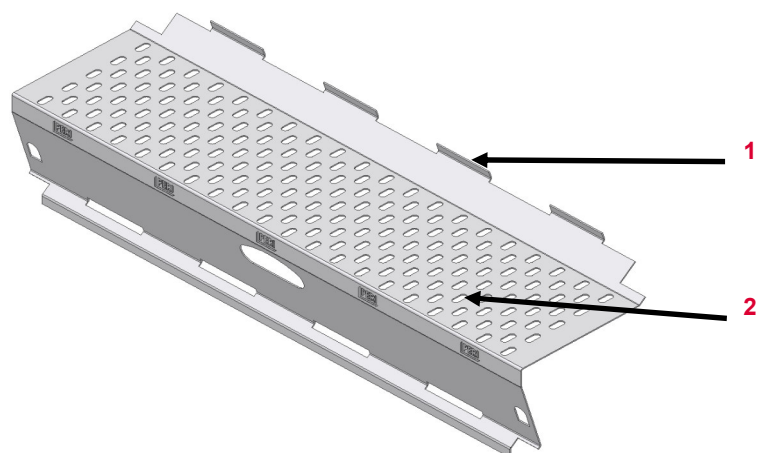

Sorszám	Megnevezés	Cikkszám
1	Csatlakozó konzol	
2	Profil	
3	Hatlapú csavar M 12x35	780156













Cikk	Cikkszám
Lépcsők UAR 100	109198
Lépcsők UAR 125	114621
Záró lépcsők UAE 100	109208
Záró lépcsők UAE 125	114180



# PERI Bérleti kritériumok

## PERI UP lépcsők













UP lépcsők	Leírás	Instrukció	Fizetési kondíciók	Típus
	<b>Csatlakozó konzol elgörbült</b>	<ul style="list-style-type: none"> <li>■ Csatlakozás lehetséges  </li> </ul>		
	<ul style="list-style-type: none"> <li>■ Vagy a csatlakozás nem lehetséges</li> </ul>			
	<ul style="list-style-type: none"> <li>■ Vagy az egyengetés nem lehetséges</li> </ul>			
	<b>Csavar hiányzik</b>			



# PERI Bérleti kritériumok

## PERI UP lépcsők



UP lépcsők	Leírás	Instrukció	Fizetési kondíciók	Típus
	<p><b>Deformálódás</b></p> <ul style="list-style-type: none"> <li>■ Ha lehetséges</li> <li>■ Ha nem lehetséges</li> </ul>	<p>Ha lehetséges: </p> <p>Ha nem lehetséges: </p>	<p>Ha lehetséges: </p> <p>Ha nem lehetséges: </p>	<p>Ha lehetséges: </p> <p>Ha nem lehetséges: </p>
	<p><b>Lépcső elgörbült   Szakadt</b></p>	<p></p>	<p></p>	<p></p>

# PERI Bérleti kritériumok

## PERI UP lépcsők



### Lépcsőkar gerenda UZS

Sorszám      Megnevezés      Cikkszám

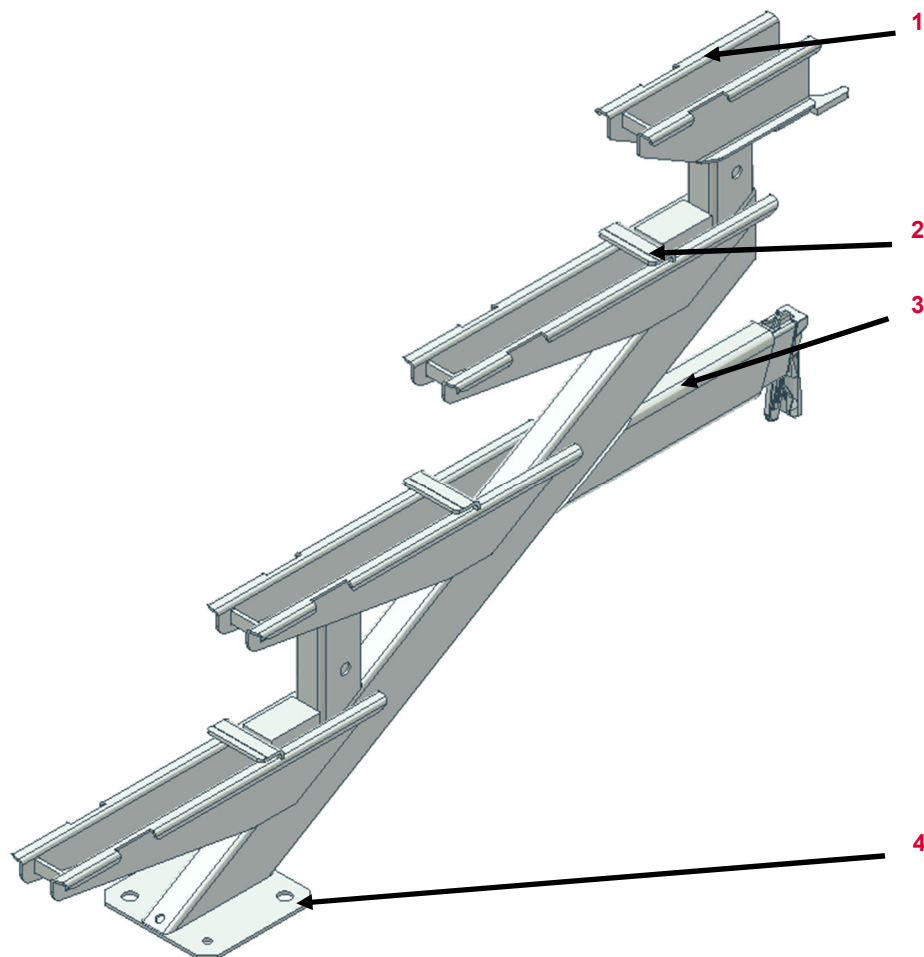

1      Lépcső profil

2      Záró lemez

3      Kapcsoló heveder

4      Talplemez

**Cikk**      **Cikkszám**

Lépcsőkar Gerenda UZS 28/27      110258

Lépcsőkar Gerenda UZS 56/50      110242











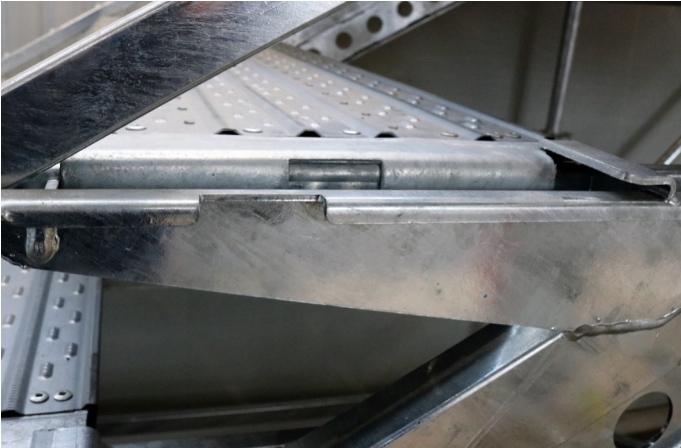







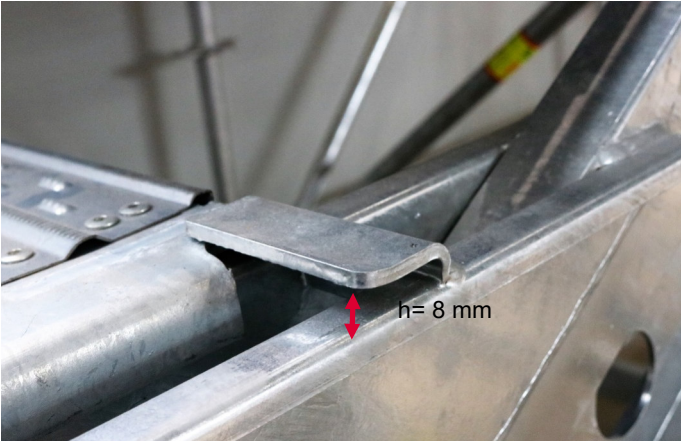

Lépcsőkar Gerenda UZS 110/83      110249

Lépcsőkar Gerenda UZS 250/150      107448

# PERI Bérleti kritériumok

## PERI UP lépcsők













Lépcsőkar gerenda UZS	Leírás	Instrukció	Fizetési kondíciók	Típus
	<b>Lépcső profil elgörbült</b>			
	<ul style="list-style-type: none"> <li>■ Lépcsőfok behelyezhető</li> </ul>	 		
	<ul style="list-style-type: none"> <li>■ Ha lehetséges</li> </ul>	 		
<ul style="list-style-type: none"> <li>■ Ha nem lehetséges</li> </ul>				
	<b>Záró lemez elgörbült</b>			
	<ul style="list-style-type: none"> <li>■ Ha lehetséges</li> </ul>	 		
	<ul style="list-style-type: none"> <li>■ Ha nem lehetséges</li> </ul>			

# PERI Bérleti kritériumok

## PERI UP lépcsők



Lépcsőkar gerenda UZS	Leírás	Instrukció	Fizetési kondíciók	Típus
	<b>Talplemez deformálódott</b> <ul style="list-style-type: none"><li>■ Ha lehetséges</li><li>■ Ha nem lehetséges</li></ul>	 	 	 
	<b>Ék hiányzik</b>			

# PERI Bérleti kritériumok

## PERI UP lépcsők



### UP lépcsőkoriát | UP pihenő koriát | UP kiegészítő koriát

Sorszám

Megnevezés

Cikkszám

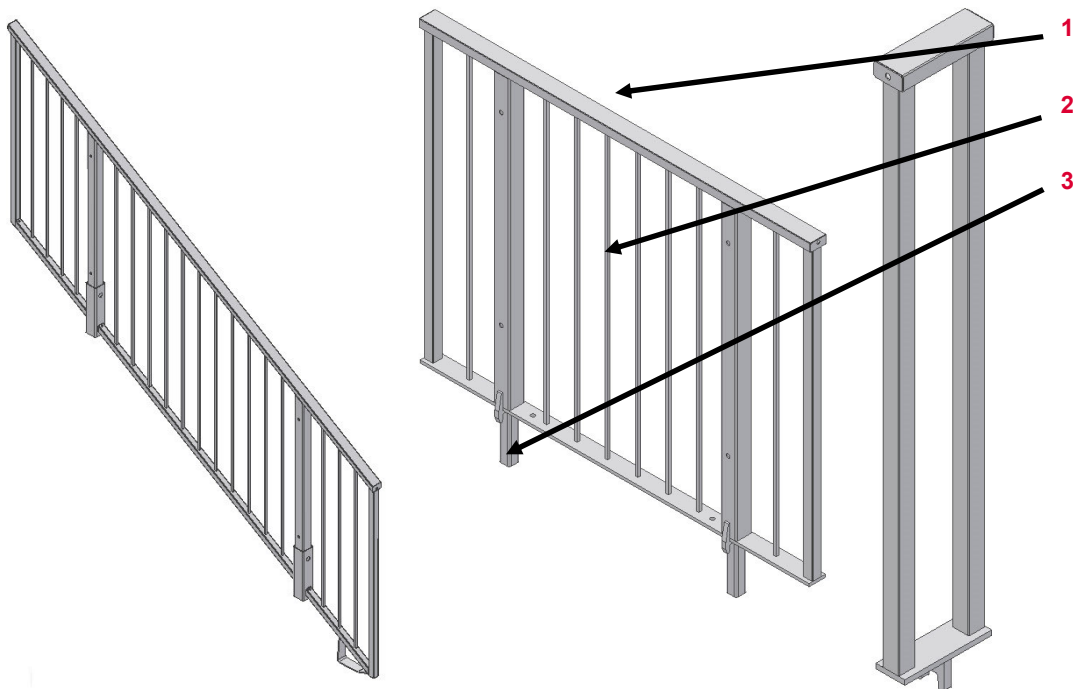

1

Koriát

2

Koriát rúd

3

Csatlakozó konzol

Cikk

Cikkszám

UP lépcsőkoriát UZG 56/50

110263

UP lépcsőkoriát UZG 110/83

110270

UP lépcsőkoriát UZG 250/150

108189

UP pihenő koriát UZG 150

108190

UP kiegészítő koriát UZG 25























108545



# PERI Bérleti kritériumok

## PERI UP lépcsők

















Védőkoriát	Leírás	Instrukció	Fizetési kondíciók	Típus
	<b>A korátoszlop csatlakozó része deformálódott</b> <ul style="list-style-type: none"> <li>■ Ha behelyezés lehetséges</li> <li>■ Ha nem lehetséges</li> <li>■ Ha nem egyengethető</li> </ul>	   	 	  
	<b>Korlát rúd elgörbült</b> <ul style="list-style-type: none"> <li>■ Hegesztés sérülése nélkül</li> <li>■ Ha sérült a hegesztés</li> </ul>	 	 	 
	<b>Lépcső korlátja elgörbült</b> <ul style="list-style-type: none"> <li>■ &lt; Megengedett görbület (L/250)</li> <li>■ Vagy &gt; 5 mm (110/83)</li> <li>■ Vagy &gt; 10 mm (250/150)</li> </ul>	 	 	 



# PERI Bérleti kritériumok

## PERI UP lépcsők





Korlát csatlakozó (108387;108218)	Leírás	Instrukció	Fizetési kondíciók	Típus
	<p><b>Henger csavar</b></p> <ul style="list-style-type: none"> <li>■ Hiányzik</li> <li>■ Sérült (nem mozgatható) erőszak miatt</li> </ul>	  	  	  
	<p><b>Deformálódás</b></p> <ul style="list-style-type: none"> <li>■ Védő korlátok összekapcsolhatóak</li> <li>■ Védőkorlátok nem kapcsolhatóak</li> </ul>	  	  	  

# PERI Bérleti kritériumok

## PERI UP lépcsők

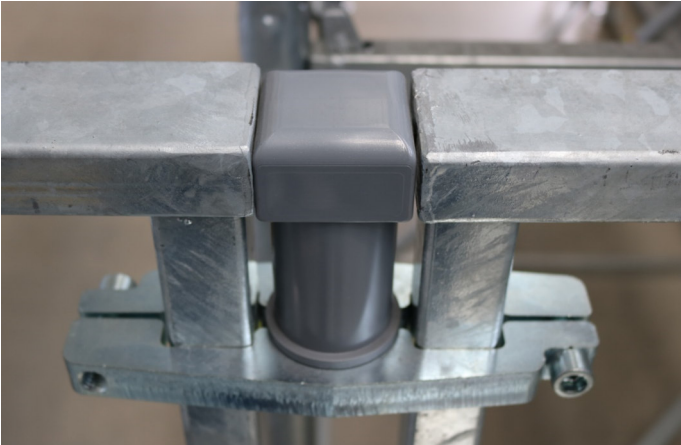

Védőkoriát átmenet	Leírás	Instrukció	Fizetési kondíciók	Típus
	<b>A koriát részei letörtek</b>			
	<ul style="list-style-type: none"> <li>■ Nincs sérülésveszély</li> </ul>			
	<ul style="list-style-type: none"> <li>■ Sérülésveszély éles részek miatt</li> </ul>			
	<ul style="list-style-type: none"> <li>■ Optikailag nem megfelelő</li> </ul>			
	<b>A hüvely részei letörtek</b>			
	<ul style="list-style-type: none"> <li>■ Csatlós lehetséges</li> </ul>			
	<ul style="list-style-type: none"> <li>■ Ha nem lehetséges</li> </ul>			

# PERI Bérleti kritériumok

## PERI UP lépcsők



UP lépcsőkorklát UAG   UAH (100742, 100830)	Leírás	Instrukció	Fizetési kondíciók	Típus
---	--------	------------	--------------------	-------



Korklát deformálódott



Villa elgörbült rozsdás



Cink réteg megújítása



088244



Hiányzó csuklós rögzítő



100826 (rögzítő UAH)



# PERI Bérleti kritériumok

## PERI UP lépcsők



Korláttartó   Végkorláttartó	Sorszám	Megnevezés	Cikkszám
------------------------------	---------	------------	----------

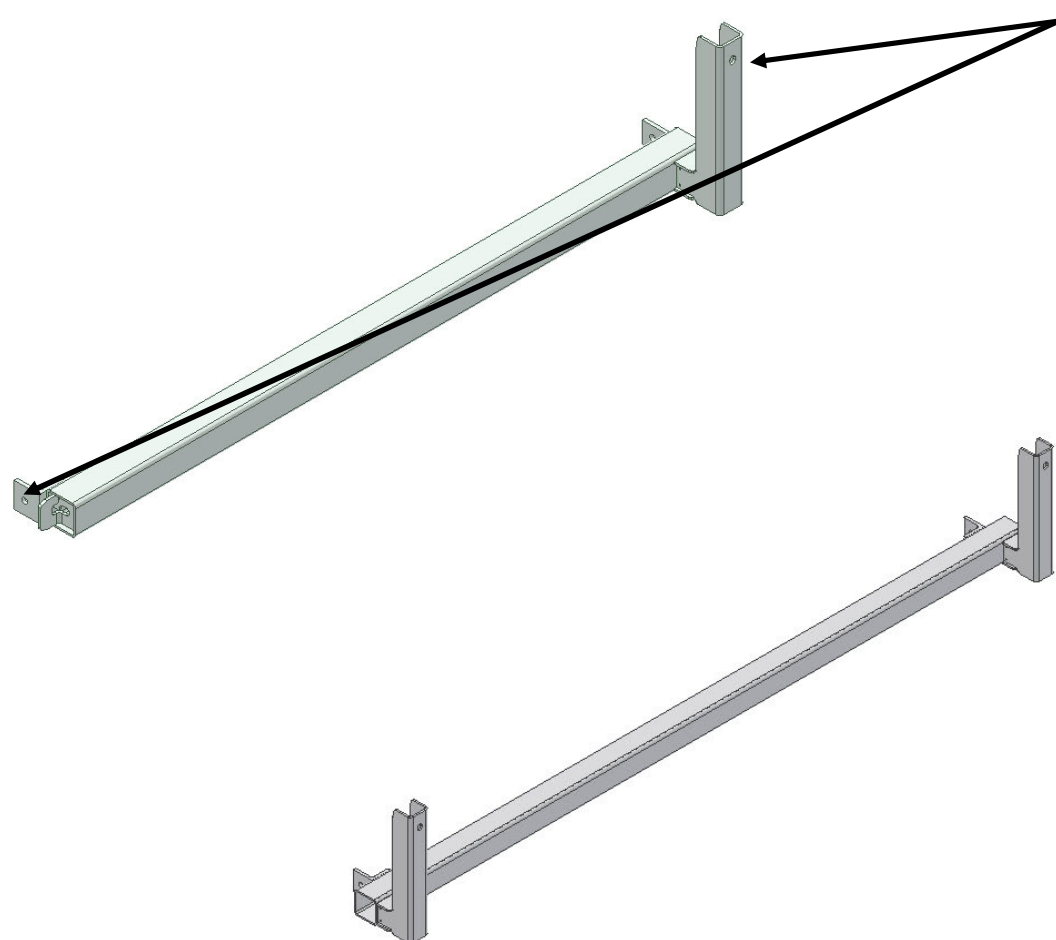













1	1	Csatlakozó	103339
2	2	Vízszintes szelvény	

Cikk	Cikkszám
Korláttartó UZF 150	107162
Korláttartó UZF 200	106582
Korláttartó UZF 250	106583
Végkorláttartó UZE 150	108536
Végkorláttartó UZE 200	107178
Végkorláttartó UZE 250	108544

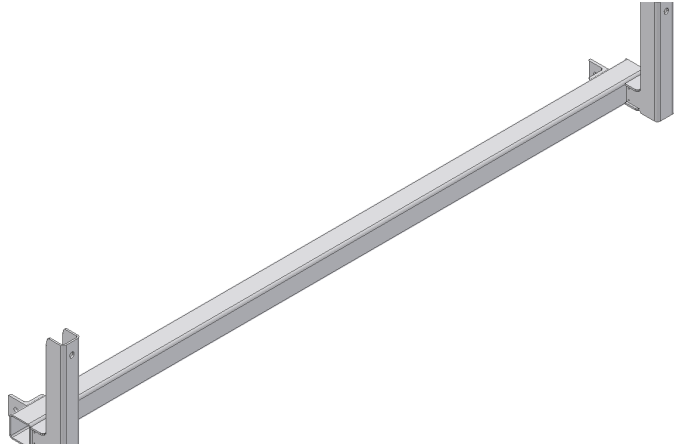
# PERI Bérleti kritériumok

## PERI UP lépcsők



Korláttartó   Végkorláttartó	Leírás	Instrukció	Fizetési kondíciók	Típus
	<b>Csatlakozó deformálódott</b> <ul style="list-style-type: none"> <li>■ Ha lehetséges</li> </ul>			
	<ul style="list-style-type: none"> <li>■ Ha nem lehetséges</li> </ul>			
	<b>Vízszintes szelvény elgörbült</b> <ul style="list-style-type: none"> <li>■ Lépcsőkorlát behelyezése lehetséges</li> </ul>			
	<ul style="list-style-type: none"> <li>■ Ha nem lehetséges</li> </ul>			

# PERI Bérleti kritériumok

## PERI UP lépcsők



UP vízszintes heveder UHP (106626)	Leírás	Instrukció	Fizetési kondíciók	Típus	
	<p><b>Horpadás a profilon</b></p>	<ul style="list-style-type: none"> <li>■ Éleket nem érinti és <math>\leq \varnothing 3</math> cm</li> </ul>			
	<ul style="list-style-type: none"> <li>■ Élek érintettek vagy <math>&gt; \varnothing 3</math> cm</li> </ul>				
	<p><b>Ékház nyitott, szakadt   Ék hiányzik</b></p>				



# PERI Bérleti kritériumok

## PERI UP lépcsők



UP vízszintes heveder UHP (106626)	Leírás	Instrukció	Fizetési kondíciók	Típus
------------------------------------	--------	------------	--------------------	-------



Élet érintő horpadás

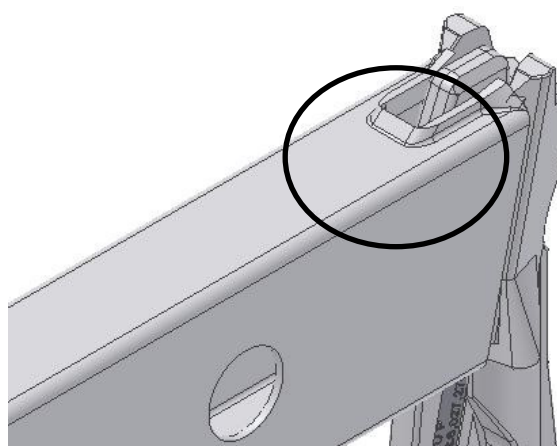

Perem horpadt

■ Ha lehetséges



088244



■ Ha nem lehetséges

















■ Anyag repedt



# PERI Bérleti kritériumok

## PERI UP lépcsők



UP vízszintes heveder UHP (106626)	Leírás	Instrukció	Fizetési kondíciók	Típus
	<b>Lyuknál horpadt</b>	<ul style="list-style-type: none"> <li>■ Ha eredeti geometriája megmarad </li> </ul>	 088244	
	<ul style="list-style-type: none"> <li>■ Vagy megváltozik</li> </ul>			
	<ul style="list-style-type: none"> <li>■ Repedés az anyagban</li> </ul>			
	<b>Profil elgörbült</b>			

# PERI Bérleti kritériumok

## PERI UP lépcsők



UP vízszintes heveder UHP (106626)	Leírás	Instrukció	Fizetési kondíciók	Típus
	<b>Elgöbült oszlopcsatlakozás</b>			
	■ Ha lehetséges			
	■ Ha nem lehetséges			
	■ Repedés a hegesztésben			
	<b>Csavar   Anya</b>			
	■ Hiányzik			
	■ Vagy erőszak miatt megsérült			

# PERI Bérleti kritériumok

## PERI UP lépcsők



Pihenő merevítő (108034; 108000; 108172; 108179)	Leírás	Instrukció	Fizetési kondíciók	Típus
--	--------	------------	--------------------	-------



### Csatlakozási pont deformálódott

- Ha lehetséges a behelyezés egyengetés után
- Ha nem lehetséges
- Vagy sérült a hegesztés



### Merevítő deformálódott

- Ha csatlakozás lehetséges, hegesztés nem sérült
- Ha sérült a hegesztés
- Kapcsolat nem lehetséges



# PERI Bérleti kritériumok

## PERI UP lépcsők



### UP acél járótabla UDS

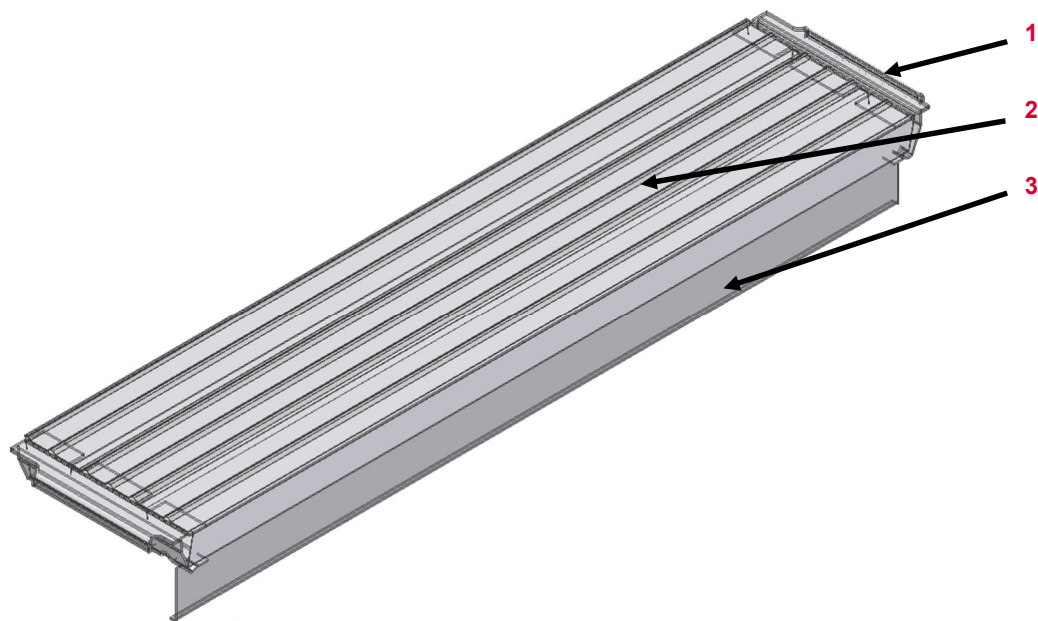

Sorszám	Megnevezés	Cikkszám
1	Csatlakozó fül	103339
2	Járófelület UDS	
3	Lemez UDS	













Cikk	Cikkszám
Acél járótabla UDS 32x150	106585
Acél járótabla UDS 32x200	106586
Acél járótabla UDS 32x250	106587



# PERI Bérleti kritériumok

## PERI UP lépcsők











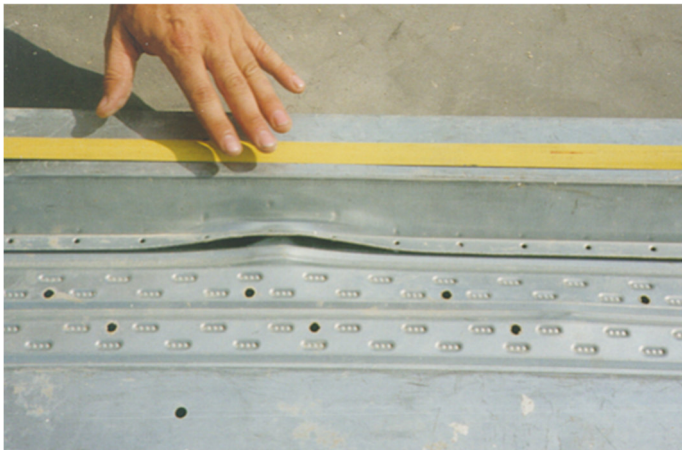

UP acél járótábla UDS Public	Leírás	Instrukció	Fizetési kondíciók	Típus
	<p><b>Horpadás a profilon</b></p> <ul style="list-style-type: none"> <li>■ Nem érinti a deformáció a Tox- Kapcsolatot</li> </ul>	 		
	<p><b>Horpadás az oldalprofilon</b></p> <ul style="list-style-type: none"> <li>■ Behelyezés könnyen lehetséges</li> </ul>	 		
	<p><b>Horpadás a járófelület végén</b></p>			

# PERI Bérleti kritériumok

## PERI UP lépcsők























UP acél járótábla UDS	Leírás	Instrukció	Fizetési kondíciók	Típus
	<p><b>A járófelületen</b></p> <ul style="list-style-type: none"> <li>■ &gt; 10 mm</li> <li>■ Tox Kapcsolat sérült</li> </ul>	  	  	  
	<p><b>A járótábla oldalán horpadt</b></p> <ul style="list-style-type: none"> <li>■ &gt; 10 mm</li> </ul>			

# PERI Bérleti kritériumok

## PERI UP lépcsők

















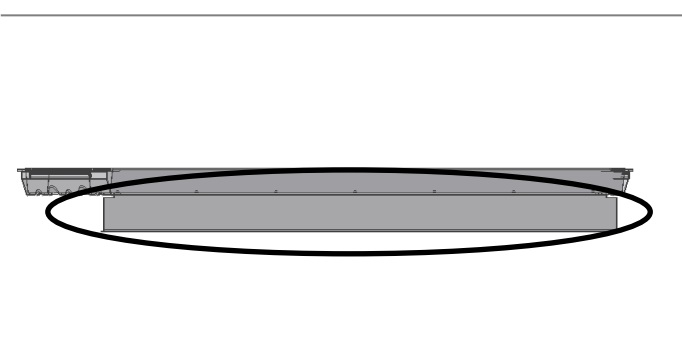

UP acél járótábla UDS	Leírás	Instrukció	Fizetési kondíciók	Típus
	<p><b>Lyuk a járófelületen</b></p> <ul style="list-style-type: none"> <li>■ ≤ 10 mm és a borda sértetlen</li> <li>■ Vagy &gt; 10 mm</li> <li>■ Vagy borda sérült</li> </ul>	<ul style="list-style-type: none"> <li>■  </li> <li>■ </li> </ul>	<ul style="list-style-type: none"> <li>■ </li> <li>■ </li> </ul>	<ul style="list-style-type: none"> <li>■ </li> <li>■ </li> </ul>
	<p><b>Hegesztett sérülések a járófelületen</b></p> <ul style="list-style-type: none"> <li>■ ≤ Ø 25 mm</li> <li>■ Végprofil érintett</li> <li>■ Merevítő érintett</li> </ul>	<ul style="list-style-type: none"> <li>■  </li> <li>■ </li> </ul>	<ul style="list-style-type: none"> <li>■ </li> <li>■ </li> </ul>	<ul style="list-style-type: none"> <li>■ </li> <li>■ </li> </ul>
	<p><b>Acél járótábla rozsdásodik</b></p> <ul style="list-style-type: none"> <li>■ Csak a felületen rozsdásodik</li> </ul>	<ul style="list-style-type: none"> <li>■ </li> </ul>	<ul style="list-style-type: none"> <li>■ </li> </ul>	<ul style="list-style-type: none"> <li>■ </li> </ul>

# PERI Bérleti kritériumok

## PERI UP lépcsők



UP acél járótábla UDS	Leírás	Instrukció	Fizetési kondíciók	Típus
	<p><b>Törött / hiányzó szegecsek</b></p>			
	<p><b>Kiemelésvédelem konzolja</b></p> <ul style="list-style-type: none"> <li>■ Deformálódott</li> <li>■ Ha nem lehetséges vagy törött</li> </ul>	 	 	 
	<p><b>Lemez elgörbült</b></p> <ul style="list-style-type: none"> <li>■ Ha lehetséges</li> <li>■ Vagy ha nem lehetséges</li> </ul>	  <p>108476 (150) 108531 (200) 108537 (250)</p>	 	 

# PERI Bérleti kritériumok

## PERI UP lépcsők



UP kiegészítő járótabla   UP pihenőlemez UZD	Sorszám	Megnevezés	Cikkszám
--	---------	------------	----------

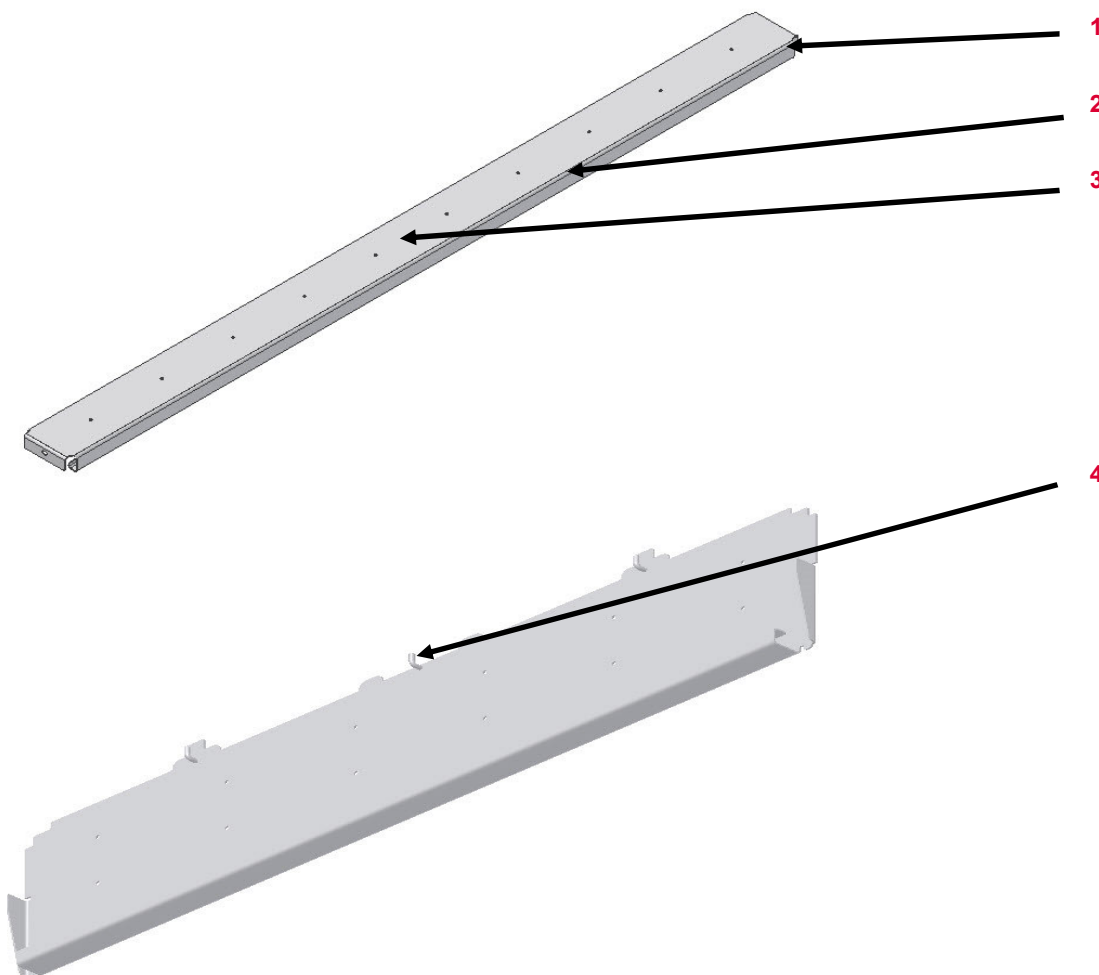

1	Rögzítő elem
2	Oldal profil
3	Járófelület
4	Horog

















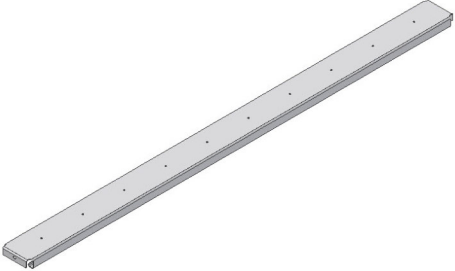



Cikk	Cikkszám
UP kiegészítő járótabla UZD 150/16	107981
UP kiegészítő járótabla UZD 150/31	107986
UP kiegészítő járótabla UZD 150/37	107977
UP kiegészítő járótabla UZD 200/16	108010
UP kiegészítő járótabla UZD 250/16	108011
UP pihenőlemez UZD 150/25	108412



# PERI Bérleti kritériumok

## PERI UP lépcsők



Hézagkitöltő   UP pihenőlemez UZD	Leírás	Instrukció	Fizetési kondíciók	Típus
	<b>Horog elgörbült</b> <ul style="list-style-type: none"> <li>■ Ha lehetséges</li> </ul>			
	<ul style="list-style-type: none"> <li>■ Ha nem lehetséges</li> </ul>			
	<b>Járótábla elgörbült</b> <ul style="list-style-type: none"> <li>■ Kapcsolás lehetséges</li> </ul>			
	<ul style="list-style-type: none"> <li>■ Vagy ha nem lehetséges</li> </ul>			
	<b>Oldalprofil deformálódott</b> <ul style="list-style-type: none"> <li>■ Ha lehetséges</li> </ul>			
	<ul style="list-style-type: none"> <li>■ Ha nem lehetséges</li> </ul>			

# PERI Bérleti kritériumok

## PERI UP lépcsők



UP podeszlemez UAB (101671)	Leírás	Instrukció	Fizetési kondíciók	Típus
-----------------------------	--------	------------	--------------------	-------

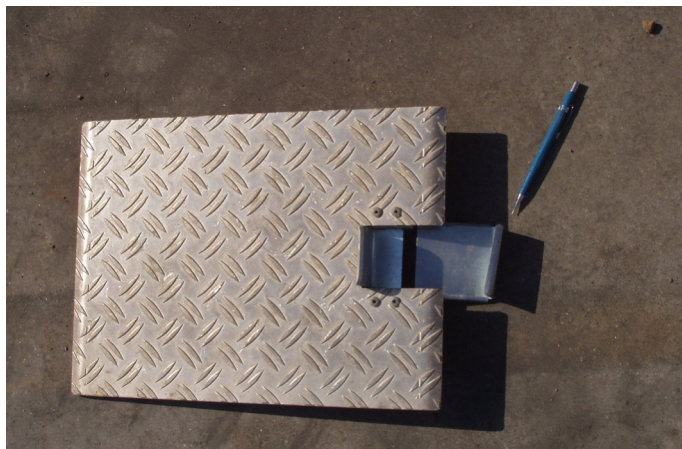

Csatlakozó lap elgörbült



088244



Leszálló összekötő deformálódott



















088244



# PERI Bérleti kritériumok

## Magyarázat



Ikon	Jelentés	Ikon	Jelentés	Ikon	Jelentés
	Nem Ok– Selejtezendő		Ügyfélnek számlázandó		Optikai kár
	OK– marad a bérleti parkban		Nincs számlázás		Funkcionális sérülés
	Selejt anyag– biztonsági okokból az anyagot tilos kiadni		Anyagot levágni		Funkcionális sérülés— anyag kiadása nem engedélyezett
	Javítás az előírások szerint		Anyagot megjelölni		Statikai sérülés— anyag kiadása nem engedélyezett
	Hideg egyengetés– utána a varratokat és a környékét ellenőrizni kell		Sérült anyag cseréje		
	Javítás gazdaságosság függvényében		Hiányzó anyag pótlása		
	Megtisztítani az anyagot				