

PERI Bérleti kritériumok

MAXIMO

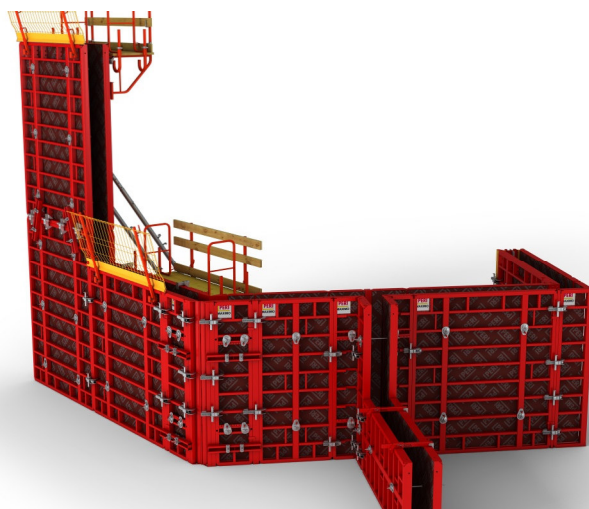

Kapcsolat

PERI kft,
zsaluzatok, állványzatok,
mérnöki szolgáltatás

H-1181 Budapest
Zádor u. 9.
Tel.: +36-1-296-09-60

Tartalom	Oldal	Változtatások	Dátum ű	Oldal
Keretváz	2	Új verzió	09/2021 O.L	
Csuklós sarok	20			
Kizsaluzó elem	25			
Falbetétek	29			
Végzáró elem	39			
Tartozékok	46			
Munkaállvány	62			
MXK	83			
MXH	105			

PERI Bérleti kritériumok

MAXIMO



MAXIMO keretváz

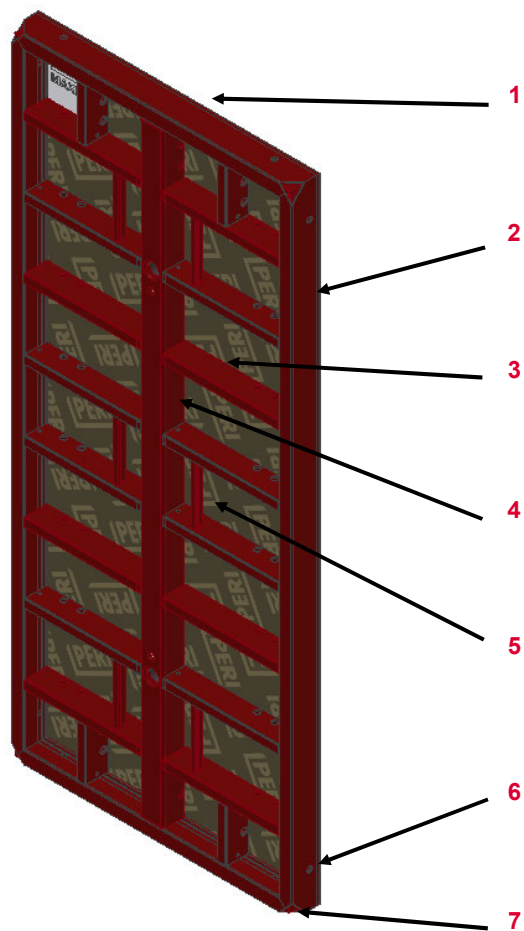

Sorszám	Megnevezés	Cikkszám
1	Rövid oldalprofil	
2	Hosszú oldalprofil	
3	Merevítő borda	
4	Átkötési merevítő borda	
5	Panel pozícionáló kar	111999
6	Hüvely	750120
7	Panel pozícionáló sarok	112337

PERI Bérleti kritériumok

MAXIMO



Cikk	Cikkszám
MX Tábla 15 330x270	116454
MX Tábla 15 330x 40	114426
MX Tábla 15 330x120	114248
MX Tábla 15 330x90	114258
MX Tábla15 330x60	114445
MX Tábla15 330x45	114452
MX Tábla15 330x30	114457
MXM Tábla 15 330x60	114464
MX Tábla 15 270x240	112006
MX Tábla 15 270x120	112022
MX Tábla 15 270x90	112045
MX Tábla 15 270x60	112200
MX Tábla 15 270x45	112078

Cikk	Cikkszám
MX Tábla 15 270x45	112078
MX Tábla 15 270x30	112090
MXM Tábla 15 270x60	112849
MX Tábla 15 120x240	112104
MX Tábla 15120x120	112143
MX Tábla 15 120x90	112152
MX Tábla 15 120x60	112221
MX Tábla 15 120x45	112232
MX Tábla 15 120x30	112239
MXM Tábla 15 120x60	117915

PERI Bérleti kritériumok

MAXIMO



Cikk	Cikkszám
Tábla MX 18, 330x240	124093
Tábla MX 18, 330x120	124126
Tábla MX 18, 330x90	124127
Tábla MX 18, 330x60	124128
Tábla MX 18, 330x45	124129
Tábla MX 18, 330x30	124130
Tábla MXM 18, 330x60	124163
Tábla MX 18, 330x270	124131
Tábla MX 18, 270x240	124132
Tábla MX 18, 270x120	124134
Tábla MX 18, 270x90	124138
Tábla MX 18, 270x60	124135
Tábla MX 18, 270x45	124136

Cikk	Cikkszám
Tábla MX 18, 270x30	124137
Tábla MXM 18, 270x60	124188
Tábla MX 18, 120x240	124139
Tábla MX 18, 120x120	124142
Tábla MX 18, 120x90	124143
Tábla MX 18, 120x60	124144
Tábla MX 18, 120x45	124145
Tábla MX 18, 120x30	124146
Tábla MXM 18, 120x60	124189











PERI Bérleti kritériumok

MAXIMO



Cikk	Cikkszám
Külső sarok MXA 120x35	112761
Külső sarok MXA 120x45	112830
Külső sarok MXA 270x35	112667
Külső sarok MXA 270x45	112806
Külső sarok MXA 330x35	114486
Külső sarok MXA 330x45	114478
Külső sarok MXA 60x35	112778
Külső sarok MXA 60x45	112837
Külső sarok MXA 90x35	126917
Külső sarok MXA 90x45	126923
Belső sarok MXI 330x60	114470
Belső sarok MXI 330x50/20	115338
Belső sarok MXI 270x60	112419

















Cikk	Cikkszám
Belső sarok MXI 270x50/20	115255
Belső sarok MXI 120x60	112689
Belső sarok MX 120x50/20	115299
Belső sarok MXI 90x60	112715
Belső sarok MXI 90x50/20	115307
Belső sarok MXI 60x60	112726
Belső sarok MXI 60x50/20	115315
Kizsaluzó sarok MXSE 330	117913
Kizsaluzó sarok MXSE 270	117914
Kizsaluzó sarok MXSE 120	117915

Keretváz	Leírás	Instrukció	Fizetési kondíciók	Típus
	<p>Oldalprofil vagy borda kiszakadva</p>			
	<p>Rövid oldalprofil sérülése</p>			
	<ul style="list-style-type: none"> ■ Daruhorog által okozott törés 	<p>Rövid oldalprofil</p>	<p>Lásd (18.old.)</p>	
	<ul style="list-style-type: none"> ■ Vagy sérülés erő hatására a keretváz többi része sértetlen 			
		<p>Rövid oldalprofil</p>	<p>Lásd (18.old.)</p>	

PERI Bérleti kritériumok

MAXIMO



















Keretváz	Leírás	Instrukció	Fizetési kondíciók	Típus
	Hosszú oldalprofil sérülése <ul style="list-style-type: none"> ■ Daruhorog által okozott törés 			
	<ul style="list-style-type: none"> ■ Vagy sérülés erő hatására 			
	Lyukak a profilon <ul style="list-style-type: none"> ■ $\leq \varnothing 3$ cm 		 088028	
	<ul style="list-style-type: none"> ■ Vagy $> \varnothing 3$cm hosszú oldalprofilon, vagy az átkötési merevítő bordán 			
	<ul style="list-style-type: none"> ■ Vagy $> \varnothing 3$ cm rövid oldalprofilon, vagy a pozicionáló karon 		 Lásd (19.old.)	

PERI Bérleti kritériumok

MAXIMO











Keretváz	Leírás	Instrukció	Fizetési kondíciók	Típus
	Törés a bordán		 Lásd (19. old.)	
	Csatlakozási lyuk sérült		 088244	
	<ul style="list-style-type: none"> ■ Ha lehetséges 		 Lásd (19.old.)	
	<ul style="list-style-type: none"> ■ Vagy ha nem lehetséges 		 Lásd (19.old.)	
	<ul style="list-style-type: none"> ■ Vagy kiszakadt 		 Lásd (19.old.)	

PERI Bérleti kritériumok

MAXIMO













Keretváz	Leírás	Instrukció	Fizetési kondíciók	Típus
	Tábla átlósan deformálódott ■ > 6 mm			
	Tábla deformálódott ■ > 8 mm			

PERI Bérleti kritériumok

MAXIMO



Keretváz	Leírás	Instrukció	Fizetési kondíciók	Típus	
	Horpadás a profilon	<ul style="list-style-type: none"> ■ ≤ 5 mm 			
	<ul style="list-style-type: none"> ■ Vagy > 5 mm 			088027	
	Deformáció a profil élén	<ul style="list-style-type: none"> ■ ≤ 3 mm 			
	<ul style="list-style-type: none"> ■ Vagy 3 és 10 mm közötti 			088236	
	<ul style="list-style-type: none"> ■ Vagy > 10 mm 		Zsaluháj kiszerezésével		088236

Keretváz	Leírás	Instrukció	Fizetési kondíciók	Típus
	<p>Repedés a hegesztésben</p>		 088028	
	<p>Repedés a profil élében</p> <ul style="list-style-type: none">■ A profil él sérülésével■ Vagy sérülése nélkül	 	 088028 	 

PERI Bérleti kriériumok MAXIMO



Keretváz	Leírás	Instrukció	Fizetési kondíciók	Típus
----------	--------	------------	--------------------	-------



Pozicionáló sarok sérült |
használhatatlan



088056



Hüvely deformálódott, hiányzik



088002



Keretváz	Leírás	Instrukció	Fizetési kondíciók	Típus
----------	--------	------------	--------------------	-------



Rozsda okozta lyukak a keretben

- Tesztelés 300g-os kalapáccsal



Menet sérült

- Tesztelje nyomatékkulccsal
110 Nm



125214 (anya)



Sarok	Leírás	Instrukció	Fizetési kondíciók	Típus
-------	--------	------------	--------------------	-------

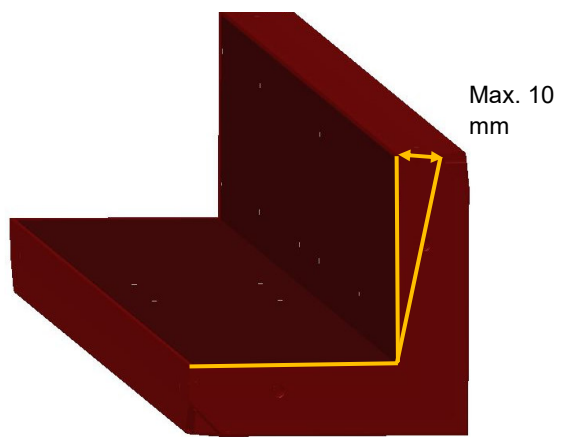

Külső sarok deformálódott

- Deformáció > 10 mm



Belső sarok deformálódott

- Deformáció > 10 mm



PERI Bérleti kritériumok

MAXIMO



Tömítés (123603; 123604)	Leírás	Instrukció	Fizetési kondíciók	Típus
--------------------------	--------	------------	--------------------	-------



Tömítés sérült



088033



Anker hüvely betonnal szennyezett



Tisztítás után kezelje PERI Clean-nel



088073



PERI Bérleti kritériumok

MAXIMO



Cikk	Rövid profil	
	Cikkszám	Javítási cikkszám
Rövid profil 30	109106	088049
Rövid profil 45	112065	088050
Rövid profil 60	109031	088051
Rövid profil 90	109023	088052
Rövid profil 120	109021	088053
Rövid profil 240	745051	088054
Rövid profil 270	745050	088055

PERI Bérleti kritériumok

MAXIMO



Cikk	Merevítő borda	
	Cikkszám	Javítási cikkszám
Merevítő borda 18	745357	088038
Merevítő borda 19	112479	088039
Merevítő borda 22	745356	088040
Merevítő borda 33	112511	088041
Merevítő borda 34	112500	088042
Merevítő borda 43	745355	088043
Merevítő borda 48	745354	088044
Merevítő borda 49	112508	088045
Merevítő borda 78	745352	088046
Merevítő borda 122	745350	088047
Merevítő borda 140	116461	088048
Merevítő borda 108	745351	088230
Merevítő borda 60	745353	088232

PERI Bérleti kritériumok

MAXIMO



MAXIMO Csuklós sarok

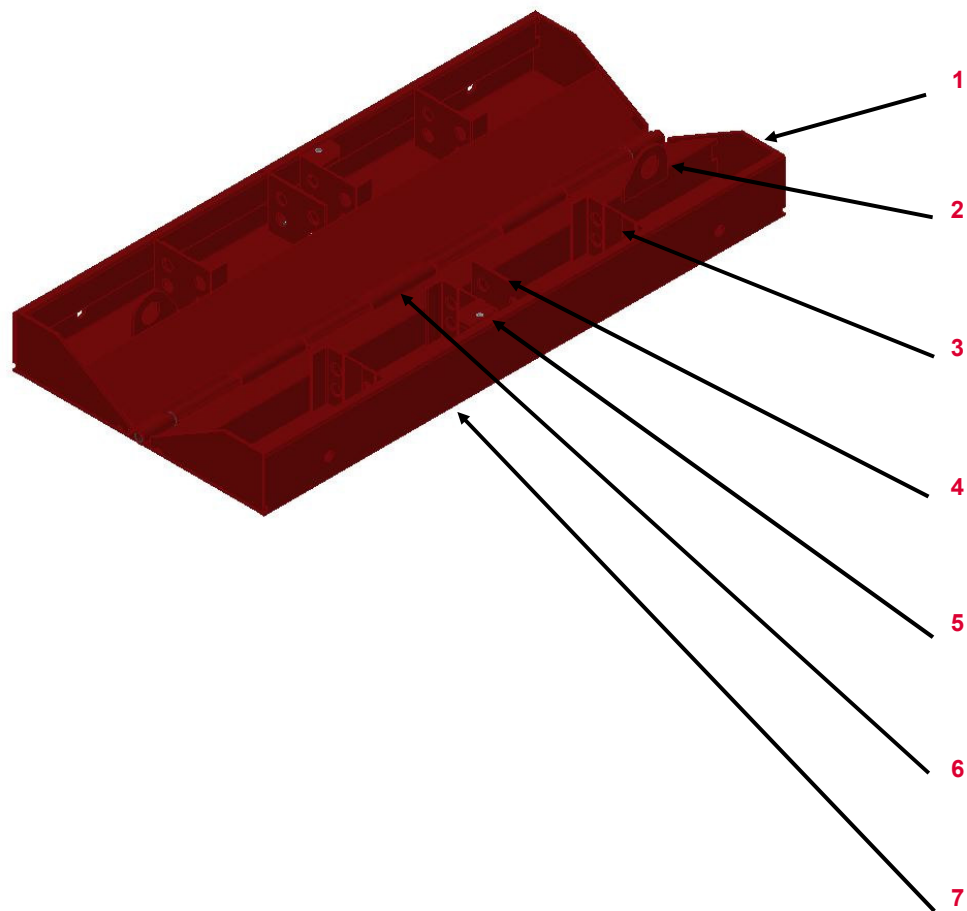











Sorszám	Megnevezés	Cikkszám
1	Saroklemez	111751
2	Szerelő szem	111709
3	Csatlakozó profil	111708
4	Csapágy profil	114105
5	Menetes lap	113210
6	Zsanér	
7	Betonzó felület	





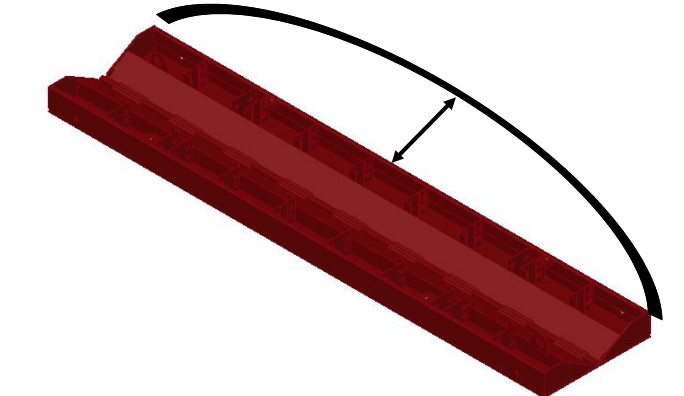















Cikk	Cikkszám
Csuklós sarok MXGA 120	111850
Csuklós sarok MXGA 270	111872
Csuklós sarok MXGA 330	114607
Csuklós sarok MXGI 120	113246
Csuklós sarok MXGI 270	113203
Csuklós sarok MXGI 330	114583
Csuklós sarok MXGI 18 120	124201
Csuklós sarok MXGI 18 270	124200
Csuklós sarok MXGI 18 330	124202

PERI Bérleti kritériumok

MAXIMO





Horpadások	Leírás	Instrukció	Fizetési kondíciók	Típus
	<p>Horpadás vagy törés a betonozó felületen</p>	 		
	<ul style="list-style-type: none"> ■ ≤ 3 mm 			088027
	<p>Keret deformálódott</p>			
	<ul style="list-style-type: none"> ■ > 8 mm 			

Lemezek	Leírás	Instrukció	Fizetési kondíciók	Típus
	Csapágyprofil vagy „rúdprofil“ deformálódott			
	<ul style="list-style-type: none"> ■ Ha lehetséges 			
	<ul style="list-style-type: none"> ■ Ha nem lehetséges 			
	<ul style="list-style-type: none"> ■ Vagy sérült a hegesztés 			
	Rögzítő szem deformálódott			
	<ul style="list-style-type: none"> ■ Ha lehetséges 			
	<ul style="list-style-type: none"> ■ Ha nem lehetséges 			
	<ul style="list-style-type: none"> ■ Vagy sérült a hegesztés 			

PERI Bérleti kritériumok

MAXIMO











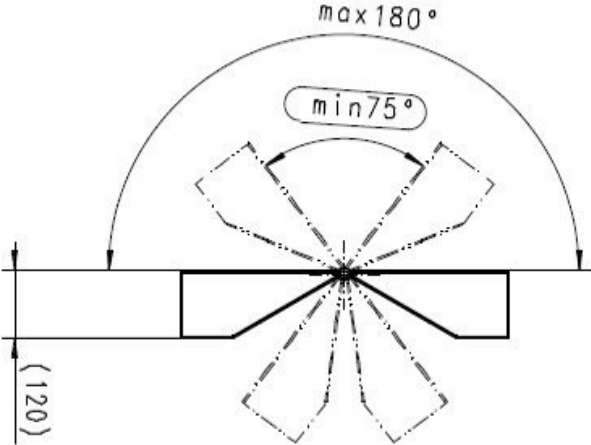





Lemezek	Leírás	Instrukció	Fizetési kondíciók	Típus
	Menetes lemez <ul style="list-style-type: none"> ■ Deformálódott 		088244	
	<ul style="list-style-type: none"> ■ Vagy repedés a hegesztésben 			
	<ul style="list-style-type: none"> ■ Vagy kiszakadt 			
	Saroklemez deformálódott vagy leszakadt <ul style="list-style-type: none"> ■ > 3 mm 		088244	
	<ul style="list-style-type: none"> ■ Ha nem lehetséges 		111842 (MXGA) 111751 (MXGI)	

PERI Bérleti kriériumok

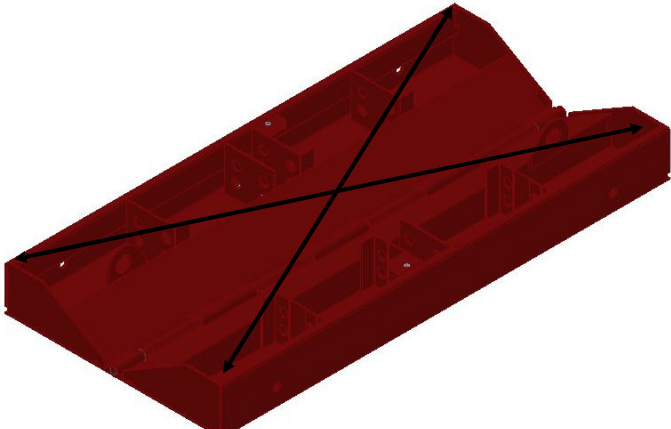
MAXIMO



Funkcionális sérülés	Leírás	Instrukció	Fizetési kondíciók	Típus
	<p>Funkció</p> <ul style="list-style-type: none"> ■ Nehezen mozog ■ Funkcióját nem tölti be ■ Funkcióját nem tölti be javítás és tisztítás után sem 	<ul style="list-style-type: none">  Tisztítás után zsanér beolajozása   	<ul style="list-style-type: none">    	<ul style="list-style-type: none">   
	<p>Elem átlósan deformálódott</p> <ul style="list-style-type: none"> ■ > 5 mm 	<ul style="list-style-type: none">  	<ul style="list-style-type: none">  	<ul style="list-style-type: none"> 

PERI Bérleti kritériumok

MAXIMO



MAXIMO Kizsaluzó sarok MXSE

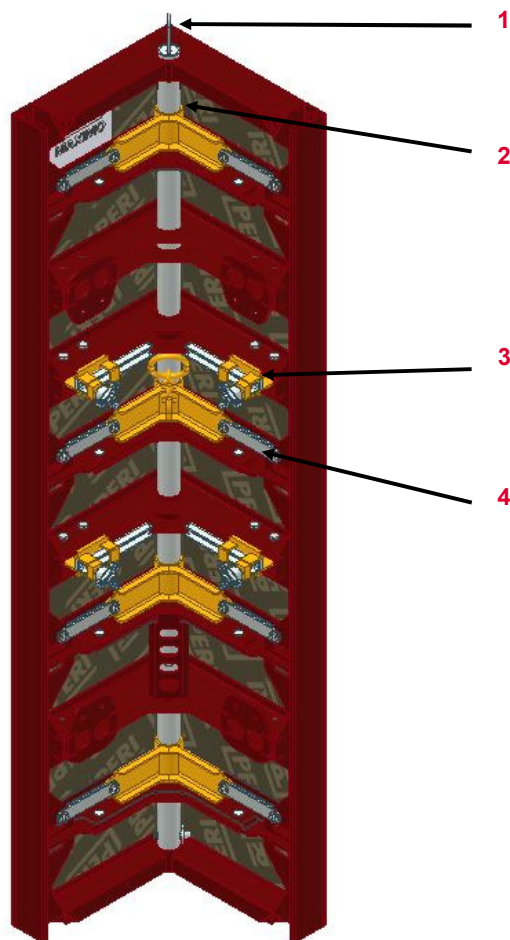









Sorszám	Megnevezés	Cikkszám
1	Feszítő lemez	118140
2	Húzó rúd	118182
3	Pozicionáló	126263
4	Kar MXSE	118136

Megnevezés	Cikkszám
Kizsaluzó elem MXSE 120	117915
Kizsaluzó elem MXSE 270	117914
Kizsaluzó elem MXSE 330	117913
Kizsaluzó elem MXSE 18, 120	125288
Kizsaluzó elem MXSE 18, 270	125286
Kizsaluzó elem MXSE 18, 330	125284
Kizsaluzó elem MXSE– Kezdő 120	134070
Kizsaluzó elem MXSE– Kezdő 270	134060
Kizsaluzó elem MXSE– Kezdő 330	134050
Kizsaluzó elem MXSE18– Kezdő 120	134080
Kizsaluzó elem MXSE18– Kezdő 270	134078
Kizsaluzó elem MXSE18– Kezdő 300	134095
Kizsaluzó elem MXSE18– Kezdő 330	134075
Kizsaluzó elem MXSE18– Kezdő 360	134088

PERI Bérleti kritériumok

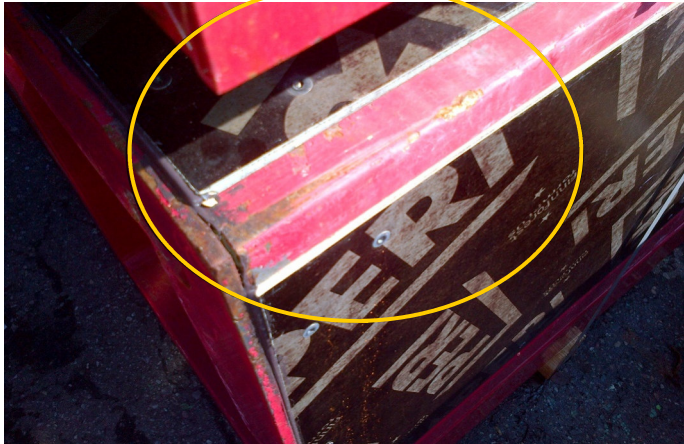
MAXIMO













Keretváz	Leírás	Instrukció	Fizetési kondíciók	Típus
	Keret és a külső merevítő sérült, nehéz szétszedni			
	Rétegzelt lemez kiáll a profilból			

PERI Bérleti kritériumok

MAXIMO



Kizsaluzó elem	Leírás	Instrukció	Fizetési kondíciók	Típus
	<p>Húzó rúdnál repedés a hegesztésben</p>		 088061	
	<p>MXSE kar deformálódott</p> <ul style="list-style-type: none"> ■ Ha lehetséges 		 088244	
	<ul style="list-style-type: none"> ■ Ha nem lehetséges 		118136 (Kar)	 088067

Kizsaluzó elem	Leírás	Instrukció	Fizetési kondíciók	Típus
----------------	--------	------------	--------------------	-------

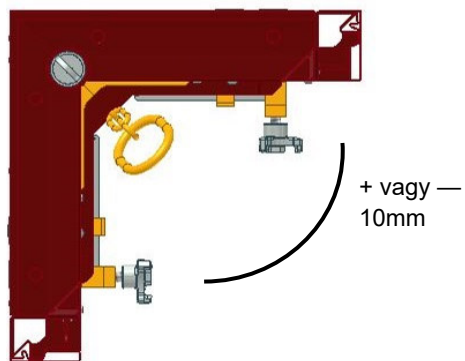

Keret deformálódott

■ > 10 mm



PERI Bérleti kritériumok

MAXIMO



MX Wall Falbetét alumínium

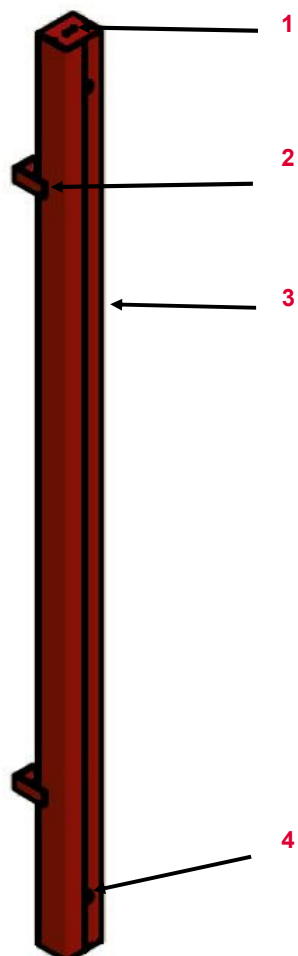

Sorszám	Megnevezés	Cikkszám
1	Talplemez	101959
2	Rögzítő profil	
3	Btonozó felület	
4	Hüvely WDA	

Megnevezés	Cikkszám
Falbetét WDA MX 120x10 Alu	114142
Falbetét WDA MX 270x10 Alu	114128
Falbetét WDA MX 330x10 Alu	114394

PERI Bérleti kritériumok

MAXIMO



Falbetét	Leírás	Instrukció	Fizetési kondíciók	Típus
----------	--------	------------	--------------------	-------

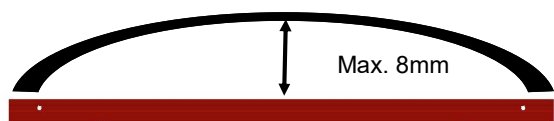

Elem deformálódott

- > 8 mm



Horpadás a zsaluzó felületen

- ≤ 3 mm
- Vagy > 3 mm < 10 mm
- Vagy > 10 mm











088244

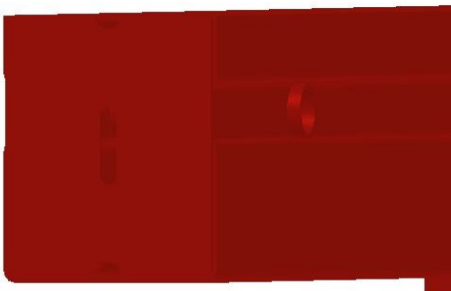

PERI Bérleti kritériumok

MAXIMO











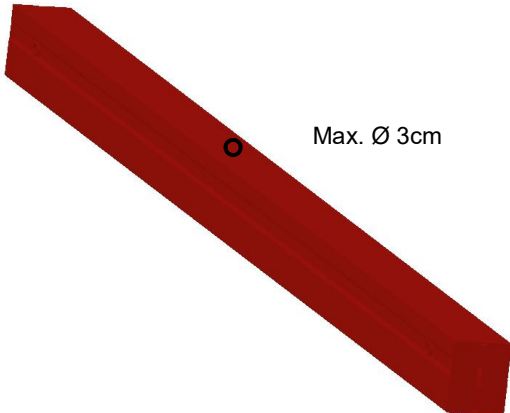

Falbetét	Leírás	Instrukció	Fizetési kondíciók	Típus
	Deformálódott talplemez (hegesztés sérülése nélkül)			
	Deformálódott talplemez (hegesztés sérülésével)		 088001	

PERI Bérleti kritériumok

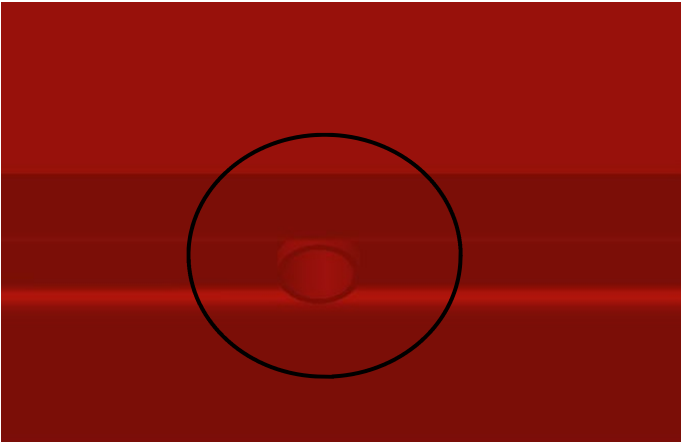
MAXIMO



Falbetét	Leírás	Instrukció	Fizetési kondíciók	Típus
	Lyuk a betonozó felületen <ul style="list-style-type: none">■ $\text{Ø} \leq 3 \text{ cm}$■ Vagy $\text{Ø} > 3 \text{ cm}$	 	 088028 	 
	Sérült / használhatatlan cső			

PERI Bérleti kritériumok

MAXIMO



Rögzítő profil	Leírás	Instrukció	Fizetési kondíciók	Típus
	Profil deformálódott			
	<ul style="list-style-type: none"> ■ ≤ 10 mm ■ Vagy > 10 mm 	<ul style="list-style-type: none"> 740781 (WDA 120) 740776 (WDA 270 + 330) 	<ul style="list-style-type: none"> 088244 088000 	<ul style="list-style-type: none">
	Profil hiányzik	<ul style="list-style-type: none"> 740781 (WDA 120) 740776 (WDA 270 + 330) 	<ul style="list-style-type: none"> 088000 	<ul style="list-style-type: none">

PERI Bérleti kritériumok

MAXIMO



MX Falbetét acél	Sorszám	Megnevezés	Cikkszám
------------------	---------	------------	----------

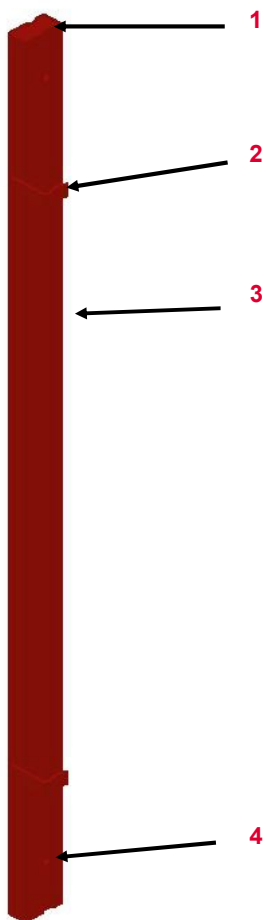

1	Talplemez
2	Rögzítőprofil
3	Betonozó felület
4	Hüvely









Megnevezés	Cikkszám
Falbetét WDA MX 330x6	114846
Falbetét WDA MX 330x5	114826
Falbetét WDA MX 330x4	114842
Falbetét WDA MX 270x6	114174
Falbetét WDA MX 270x5	114186
Falbetét WDA MX 270x4	114165
Falbetét WDA MX 120x6	114181
Falbetét WDA MX 120x5	114191
Falbetét WDA MX 120x4	114212

Falbetét	Leírás	Instrukció	Fizetési kondíciók	Típus
	<p>Elem deformálódott</p> <ul style="list-style-type: none"> ■ > 8 mm 			
	<p>Horpadás a betonozó felületen</p> <ul style="list-style-type: none"> ■ ≤ 3 mm 			
	<ul style="list-style-type: none"> ■ Vagy > 3 mm until ≤ 10 mm 			
	<ul style="list-style-type: none"> ■ Vagy > 10 mm 			

PERI Bérleti kritériumok

MAXIMO











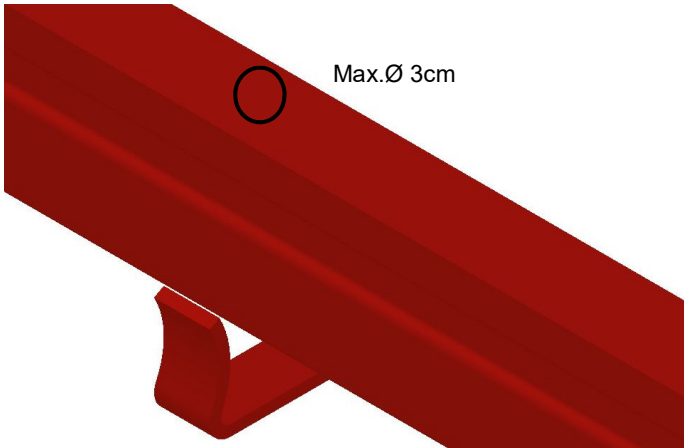

Falbetét	Leírás	Instrukció	Fizetési kondíciók	Típus
	Deformálódott talplemez (Hegesztés sérülése nélkül)			
	Deformálódott talplemez (Hegesztés sérülésével)		 088001	

PERI Bérleti kritériumok

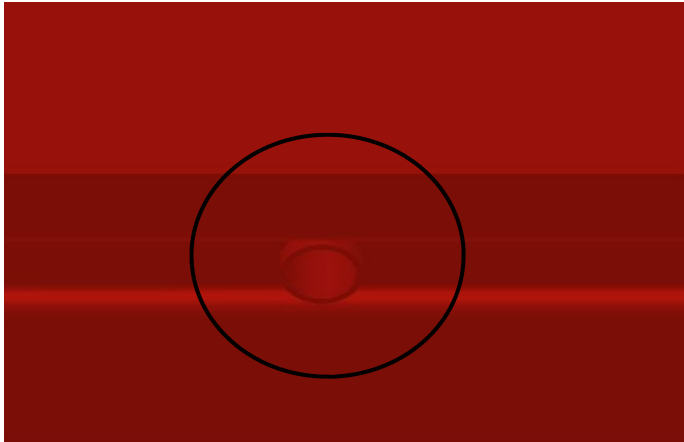
MAXIMO











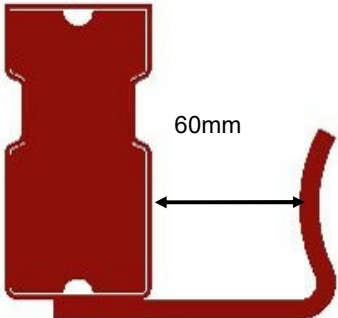

Falbetét	Leírás	Instrukció	Fizetési kondíciók	Típus
	Lyuk a betonozó felületen <ul style="list-style-type: none"> ■ $\varnothing \leq 3 \text{ cm}$ 		 088028	
	<ul style="list-style-type: none"> ■ Vagy $\varnothing > 3 \text{ cm}$ 			
	Hüvely sérült / használhatatlan			

PERI Bérleti kritériumok

MAXIMO



Rögzítő profil	Leírás	Instrukció	Fizetési kondíciók	Típus
	<p>Profil deformálódott</p> <ul style="list-style-type: none"> ■ ≤ 10 mm ■ Vagy > 10 mm 	 	 088244  088164	 
		<p>Profil hiányzik vagy megrepedt</p>		 088164

Végzáró elem AT

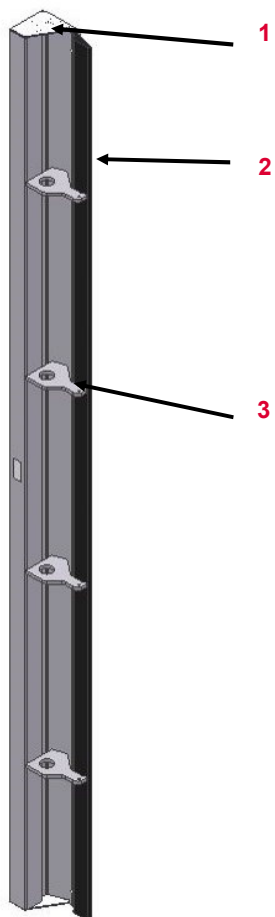









Sorszám	Megnevezés	Cikkszám
1	Végzáró lemez	100782
2	Tömítő profil	
3	Horog	100781

Megnevezés	Cikkszám
Végzáró elem TRIO AT 270x5	105953
Végzáró elem TRIO AT 270x3	023060
Végzáró elem TRIO AT 120x5	105978
Végzáró elem TRIO AT 120x3	023067

PERI Bérleti kritériumok

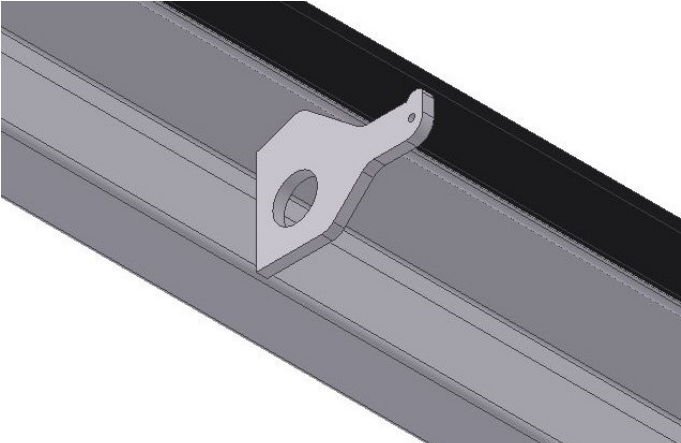
MAXIMO







Profil	Leírás	Instrukció	Fizetési kondíciók	Típus
	Tömítő profil vágott vagy szakadt ■ > 3 mm			
	Repedés a horogban vagy hiányzik		 088154	

PERI Bérleti kritériumok

MAXIMO

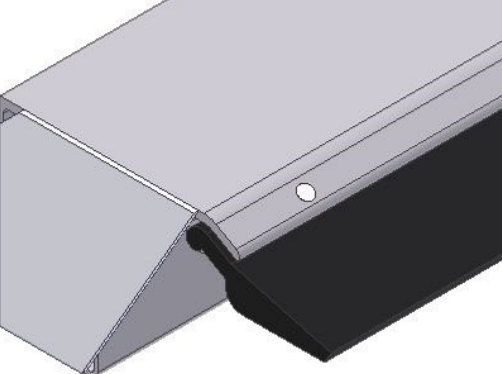

Profil	Leírás	Instrukció	Fizetési kondíciók	Típus
	<p>Profil elgörbült</p> <ul style="list-style-type: none"> ■ > 8 mm 			
	<p>Fedőlap sérült</p> <ul style="list-style-type: none"> ■ > 3 mm ≤ 10 mm 		 088244	
	<ul style="list-style-type: none"> ■ Vagy > 10 mm 		 088151	



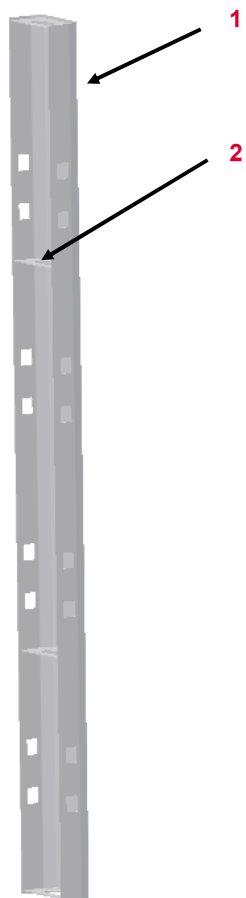





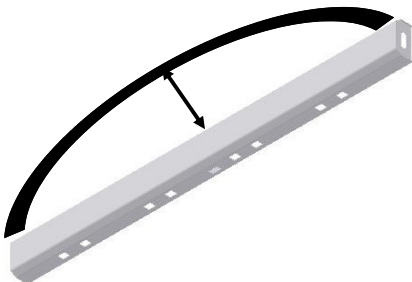

TRIO Végzáró MT



Sorszám	Megnevezés	Cikkszám
---------	------------	----------

- | | | |
|---|-------------|--|
| 1 | Profil | |
| 2 | Belső lemez | |

Megnevezés	Cikkszám
Végzáró TRIO MT 270x35/36	023065
VégzáróTRIO MT 270x30	023064
VégzáróTRIO MT 270x24/25	023062
VégzáróTRIO MT 270x20	023061
VégzáróTRIO MT 120x35/36	023072
VégzáróTRIO MT 120x30	023071
VégzáróTRIO MT 120x24/25	023069
VégzáróTRIO MT 120x20	023068

Végzáró MT	Leírás	Instrukció	Fizetési kondíciók	Típus
	<p>Panel horpadt, deformálódott</p> <ul style="list-style-type: none"> ■ > 8 mm 			
	<p>Belső lemez sérült / deformálódott</p> <ul style="list-style-type: none"> ■ Ha lehetséges (hegesztés sérülése nélkül) ■ Ha nem lehetséges vagy sérült a hegesztés 	 	 088244 	 

PERI Bérleti kritériumok

MAXIMO



TRIO Végzáró MTF

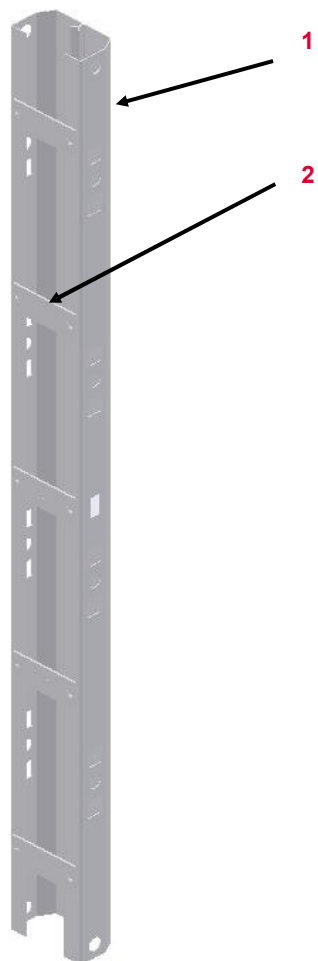

Sorszám	Megnevezés	Cikkszám
---------	------------	----------

1 Profil

2 Lemez

Megnevezés	Cikkszám
Végzáró TRIO MTF 270x35/36	023076
Végzáró TRIO MTF 270x30	023077
Végzáró TRIO MTF 270x24/25	023075
Végzáró TRIO MTF 270x20	023074
Végzáró TRIO MTF 120x35/36	023079
Végzáró TRIO MTF 120x30	023078
Végzáró TRIO MTF 120x24/25	023080
Végzáró TRIO MTF 120x20	023081

Vágzáró MTF	Leírás	Instrukció	Fizetési kondíciók	Típus
-------------	--------	------------	--------------------	-------

Panel elgörbült

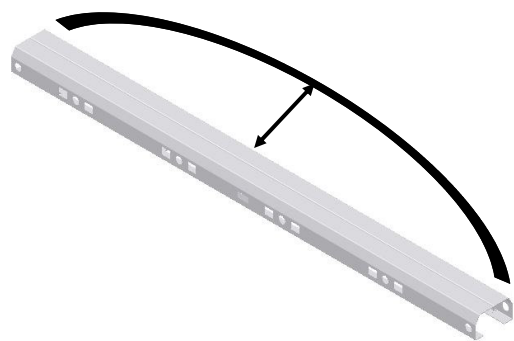

■ > 8 mm

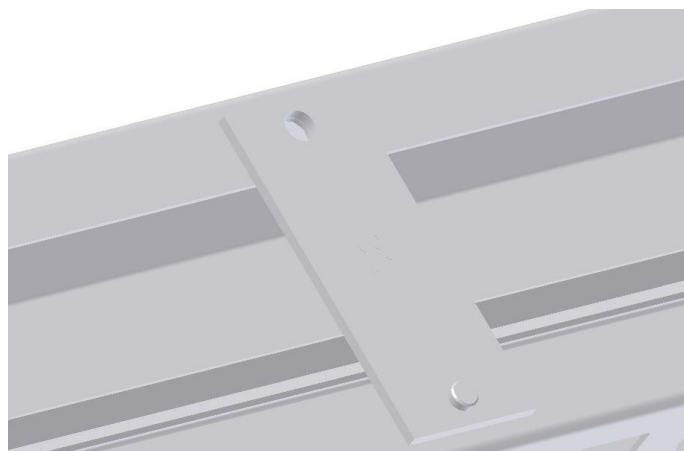

Deformálódott / hiányzó lemez









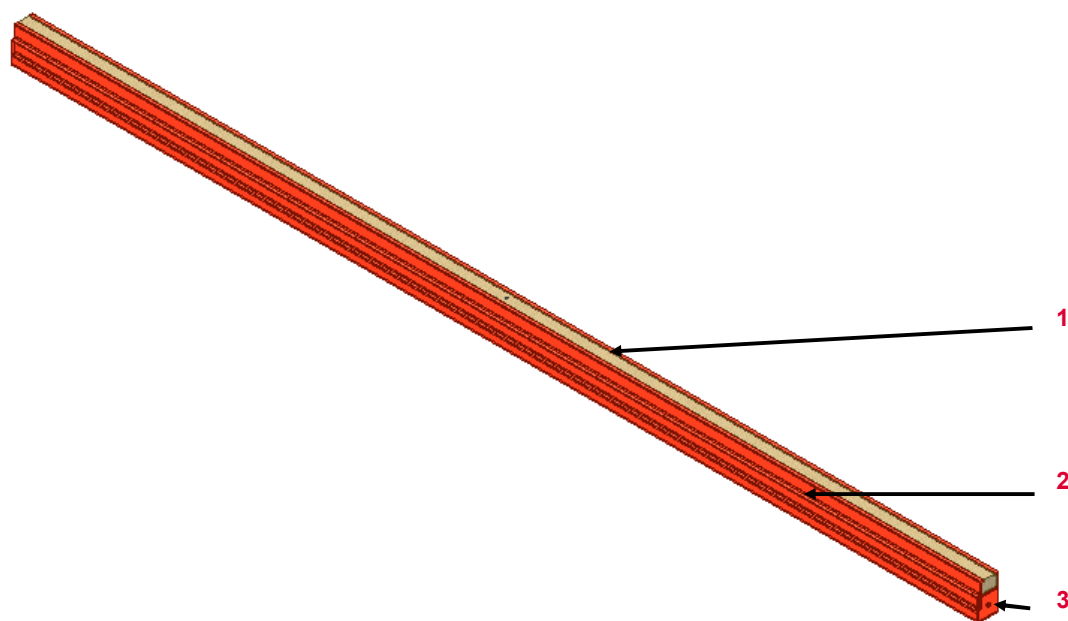







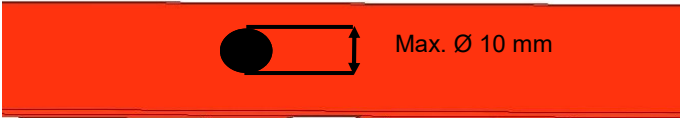

Kiegészítő profil

Sorszám	Megnevezés	Cikkszám
---------	------------	----------

- | | |
|---|------------|
| 1 | Fabetét |
| 2 | Profil |
| 3 | Talp lemez |

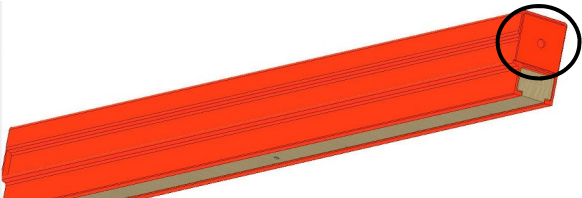















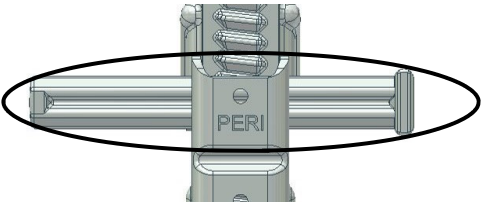

Cikk	Cikkszám
Kiegészítő profil TPP 120 Alu	101823
Kiegészítő profil TPP 270 Alu	101813
Kiegészítő profil TPP 330 Alu	101829

Kiegészítő profil	Leírás	Instrukció	Fizetési kondíciók	Típus
	<p>Kopott fa</p>			
	<p>Profil elgörbült</p> <ul style="list-style-type: none"> ■ > 8 mm 			
	<p>Lyuk a profilon</p> <ul style="list-style-type: none"> ■ $\varnothing > 10$ mm 			
	<p>Deformálódott talplemez</p>			

PERI Bérleti kritériumok

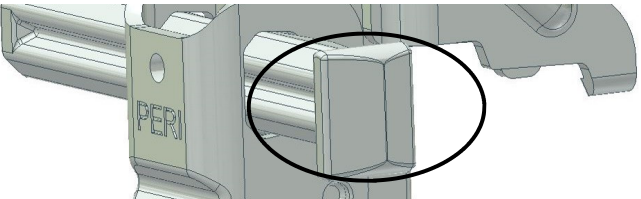
MAXIMO



BFD Kapocs (023500)	Leírás	Instrukció	Fizetési kondíciók	Típus
	<p>Deformálódott karom</p>		 088244	
	<p>Szétesik</p>		 088032	
	<p>Ék elgörbült / használhatatlan</p>	 		
	<p>Repedés az ütőfelületen</p>	 		

PERI Bérleti kritériumok

MAXIMO



MX Anker	Sorszám	Megnevezés	Cikkszám
----------	---------	------------	----------

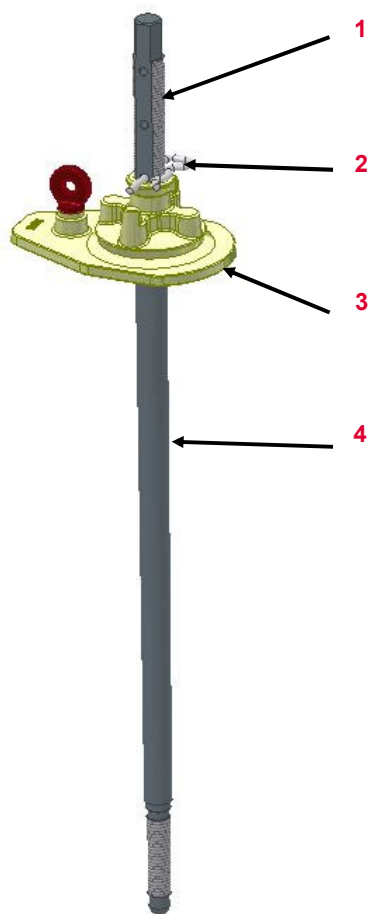











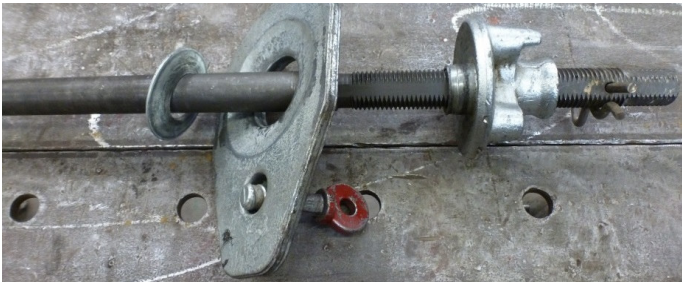

1	Menet	
2	Sasszeg MX	113256
3	Anker lemez anyával	123910
4	Anker	

Cikk	Cikkszám
MX 15 Anker 15-25	113847
MX 15 Anker 20-30	112387
MX 15 Anker 30-40	112464
MX 18 Anker 15-25	123901
MX 18 Anker 20-30	123902
MX 18 Anker 30-40	123903
MX 18 Anker 40-50	123904
MX 18 Anker 50-60	123905

PERI Bérleti kritériumok

MAXIMO



MAXIMO Anker	Leírás	Instrukció	Fizetési kondíciók	Típus
	Szennyezett menet		 088075	
	Szétesett alkatrészek		 088075	
	Sérült menet		 088075	

PERI Bérleti kritériumok

MAXIMO



MX Szárnyasanya (112386, 123900)	Leírás	Instrukció	Fizetési kondíciók	Típus
----------------------------------	--------	------------	--------------------	-------



Deformálódott / hiányzó csap















Deformálódott hüvely



PERI Bérleti kritériumok

MAXIMO



Anker kulcs MX15 (116841)	Leírás	Instrukció	Fizetési kondíciók	Típus
	Kiesett hatszögletű fej (2. generációs kulcsnál)			
	Hatszögletű fej szorul szennyeződés miatt (2. generációs kulcsnál)			
	Sérült rugó			

PERI Bérleti kritériumok

MAXIMO



MX Homlokhorgony DW20 (115640)	Leírás	Instrukció	Fizetési kondíciók	Típus
--------------------------------	--------	------------	--------------------	-------

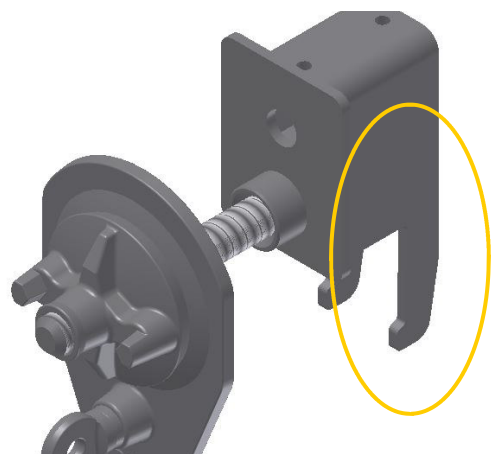

Deformálódott karom



088244

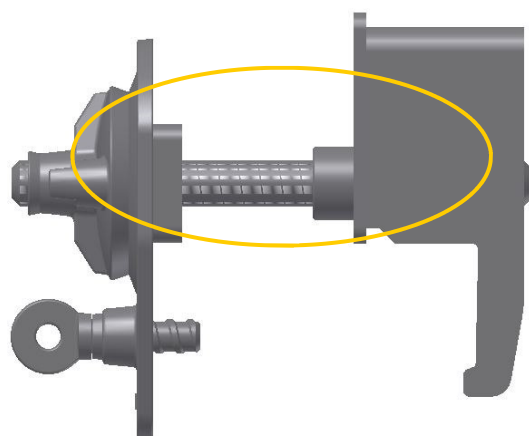

Szennyezett menet



PERI Bérleti kritériumok

MAXIMO



MAR Kiegyenlítő heveder (124941; 124942)	Leírás	Instrukció	Fizetési kondíciók	Típus
--	--------	------------	--------------------	-------



Kettős horog deformálódott



088035



Kettős horog eltört



088035



PERI Bérleti kriériumok

MAXIMO



MAR Kiegyenlítő heveder (124941; 124942)	Leírás	Instrukció	Fizetési kondíciók	Típus
--	--------	------------	--------------------	-------



Profil deformálódott



088244



Vezető deformálódott



124940





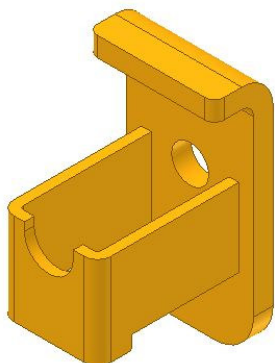









088076



PERI Bérleti kritériumok

MAXIMO



TRIO Támaszkapcsoló (023660)	Leírás	Instrukció	Fizetési kondíciók	Típus
	Repedés a hegesztésben	 		
	Deformálódott részek		 088244	
	Törött anya	 030190 (Háromszárnyú anya)	 088541	

PERI Bérleti kritériumok

MAXIMO



TRIO Húzó nyomó heveder (123842; 115350)	Sorszám	Megnevezés	Cikkszám
--	---------	------------	----------

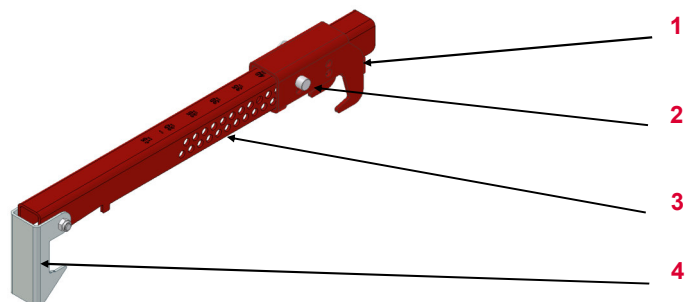

1	Rögzítő fej	115349
2	Csap D=12	115331
3	Távtartó sín	123841
4	Biztosító horog	114390

TRIO Húzó nyomó heveder	Leírás	Instrukció	Fizetési kondíciók	Típus
-------------------------	--------	------------	--------------------	-------



Deformálódott karmok



088244



Bevágás a lyukaknál



PERI Bérleti kritériumok

MAXIMO

















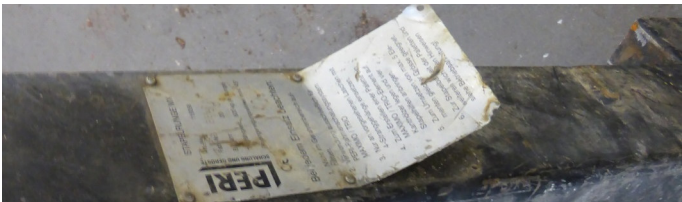

Állító konzol MX (101633)	Leírás	Instrukció	Fizetési kondíciók	Típus
	Deformálódott alkatrészek		 088244	
	Szennyezett részek	 Utána funkció tesztelése		

PERI Bérleti kritériumok

MAXIMO



Szállító rakonca MX (115058)	Leírás	Instrukció	Fizetési kondíciók	Típus
	Deformálódott profil		 088244	
	Repedés a hegesztésben			
	Olvashatatlan, hiányzó adattábla		 088037	
	Deformálódott részek		 088244	

PERI Bérleti kriériumok MAXIMO



Mágneses kónusz (112937; 127425)

Leírás

Instrukció

Fizetési kondíciók

Típus

Sérülés a műanyagon



Betonnal szennyezett

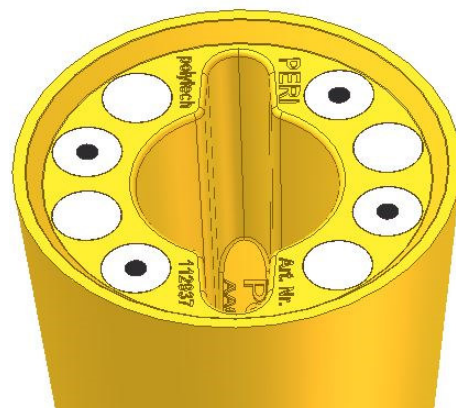

Mágneses csavarkulcs (126696)	Leírás	Instrukció	Fizetési kondíciók	Típus
-------------------------------	--------	------------	--------------------	-------

Deformálódott kulcs

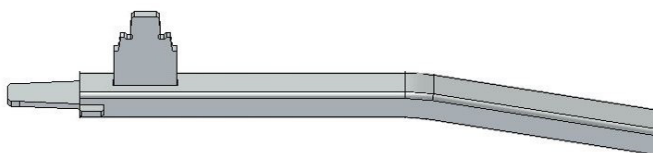

Deformálódott fej



088244

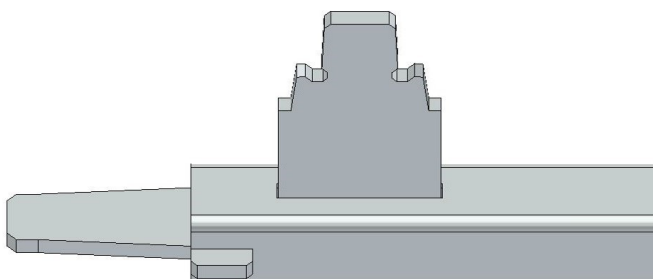

PERI Bérleti kritériumok

MAXIMO



MXP Munkaállvány nyílással (115935; 115937)

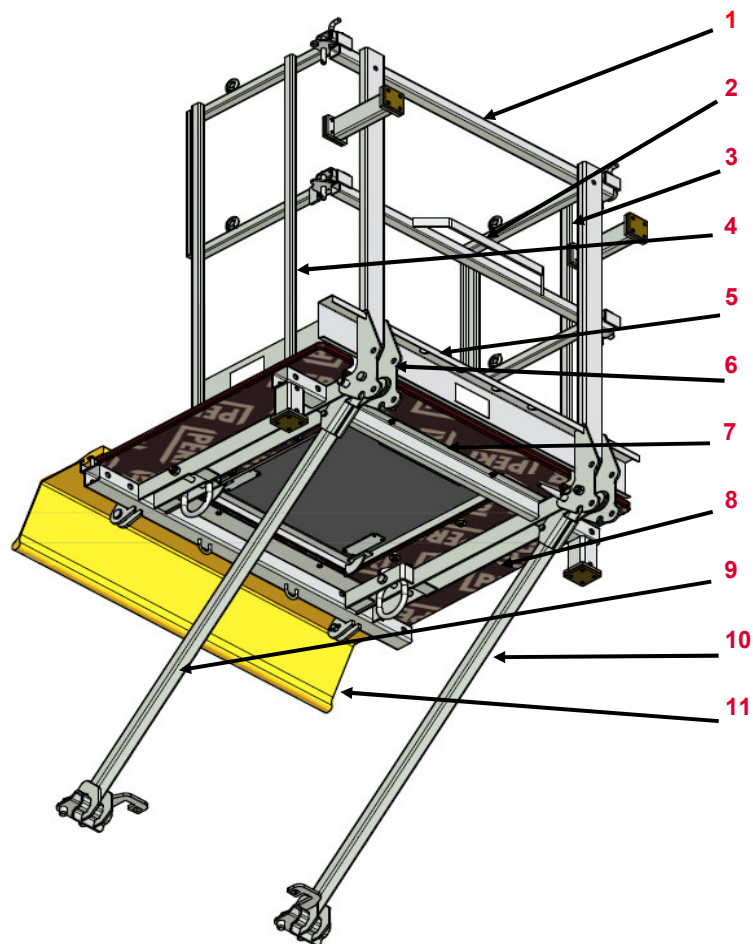









Sorszám	Megnevezés	Cikkszám MXP240	Cikkszám MXP120
1	Védőkorlát	116171	116402
2	Merevítő konzol	116349	116349
3	Jobb oldali védőkorlát	115946	115946
4	Bal oldali védőkorlát	115945	115945
5	Láblemez	116169	116399
6	Csukló	116618	116618
7	Merevítő borda	116160	116396
8	Fedélzet nyílással MXP	116080	116105
9	Merevítő csatlakozó bal	116012	116012
10	Merevítő csatlakozó jobb	116015	116015
11	Gumi porvédő	114600	116390

Felület	Leírás	Instrukció	Fizetési kondíciók	Típus
	<p>Korlát deformálódott</p> <ul style="list-style-type: none"> ■ ≤ 5 mm ■ Vagy > 5 mm 			
		<p>MXP 240 (116171) MXP 120 (116402)</p>	<p>088086 088085</p>	
	<p>Merevítő konzol deformálódott</p> <ul style="list-style-type: none"> ■ Hegesztés repedése nélkül ■ Hegesztés repedésével 		<p>088244</p>	

PERI Bérleti kritériumok

MAXIMO



Felület	Leírás	Instrukció	Fizetési kondíciók	Típus
	Láblemez deformálódott		 088244	
	Láblemezen lévő lyukak deformálódtak, szakadtak	 116399 (120x100) 116169 (240x100)		

PERI Bérleti kritériumok

MAXIMO











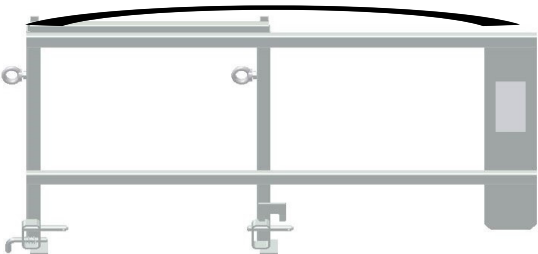



Felület	Leírás	Instrukció	Fizetési kondíciók	Típus
	Csukló deformálódott			
	■ ≤ 5 mm		 088244	
	■ Vagy > 5 mm	 116618		

PERI Bérleti kritériumok

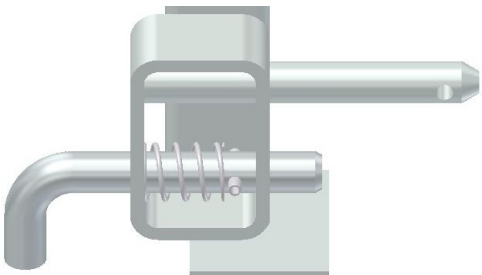
MAXIMO



Oldalsó védőkorlát bal és jobb	Leírás	Instrukció	Fizetési kondíciók	Típus
	<p>Oldalsó védőkorlát deformálódott</p> <p>■ > 5 mm</p>			
	<p>Merevítő deformálódott , megtört</p>	 116050		
	<p>Csap sérült / hiányzik</p>	 117956 (csap) 114288 (rugó) 722930 (hasított ék)	 088192	

PERI Bérleti kritériumok

MAXIMO





Járófelület	Leírás	Instrukció	Fizetési kondíciók	Típus
	Felület kopott	 116080 (240x100) 116105 (120x100)	 088079 088080	
	Járófelület erőszak miatt sérült	 116080 (240x100) 116105 (120x100)	 088079 088080	

PERI Bérleti kritériumok

MAXIMO



Nyílás	Leírás	Instrukció	Fizetési kondíciók	Típus
	Funkcióját nem tölti be, erőszakos hatás miatt	 115141	 088099	

PERI Bérleti kritériumok

MAXIMO



Felület	Leírás	Instrukció	Fizetési kondíciók	Típus
	Gumi porvédőn vágás, szakadás	 114600 (240x100) 116390 (120x100)	 088095 088094	
	Csatlakozó merevítő elgörbült ■ > 5 mm	 116015 (jobb) 116012 (bal)	 088089	

PERI Bérleti kritériumok







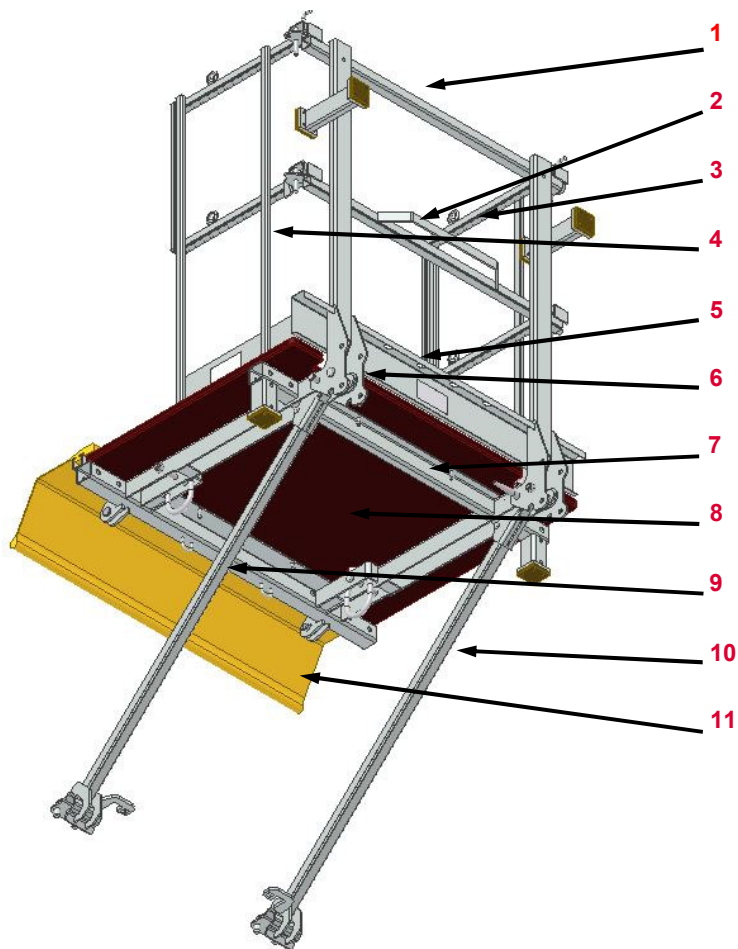







MAXIMO



MXP Munkaállvány (115936; 115938)











Sorszám	Megnevezés	Cikkszám MXP240	Cikkszám MXP120
1	Korlát	116171	116402
2	Merevítő konzol	116349	116349
3	Oldalsó védőkorlát jobb	115946	115946
4	Oldalsó védőkorlát bal	115945	115945
5	Láblemez	116169	116399
6	Csukló	116618	116618
7	Merevítő borda	116160	116396
8	MXP Felület nyílás nélkül	116088	116089
9	Csatlakozó merevítő bal	116012	116012
10	Csatlakozó merevítő jobb	116015	116015
11	Gumi porvédő	114600	116390

Felület	Leírás	Instrukció	Fizetési kondíciók	Típus
	<p>Korlát deformálódott</p> <ul style="list-style-type: none"> ■ ≤ 5 mm ■ Vagy > 5 mm 	<ul style="list-style-type: none">    116171 (MXP 240) 116402 (MXP 120) 	<ul style="list-style-type: none">   088086 088085 	<ul style="list-style-type: none">  
	<p>Merevítő konzol deformálódott</p> <ul style="list-style-type: none"> ■ Hegesztés sérülése nélkül ■ Hegesztés sérülésével 	<ul style="list-style-type: none">   	<ul style="list-style-type: none">  088244  	<ul style="list-style-type: none">  

PERI Bérleti kritériumok

MAXIMO



Felület	Leírás	Instrukció	Fizetési kondíciók	Típus
	Láblemez deformálódott		 088244	
	Láblemezen lévő lyukak deformálódtak, szakadtak		 116399 (120x100) 116169 (240x100)	

PERI Bérleti kritériumok

MAXIMO











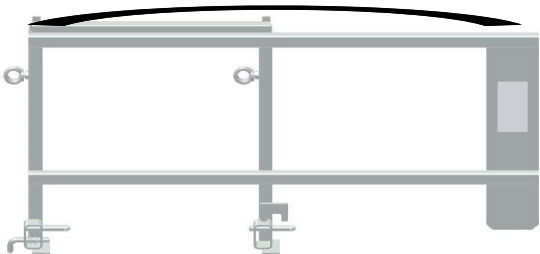



Felület	Leírás	Instrukció	Fizetési kondíciók	Típus
	Csukló deformálódott			
	■ ≤ 5 mm		 088244	
	■ Vagy > 5 mm	 116618		

PERI Bérleti kritériumok

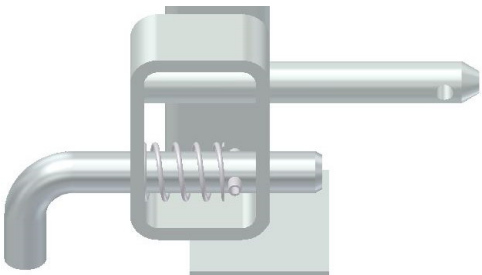
MAXIMO









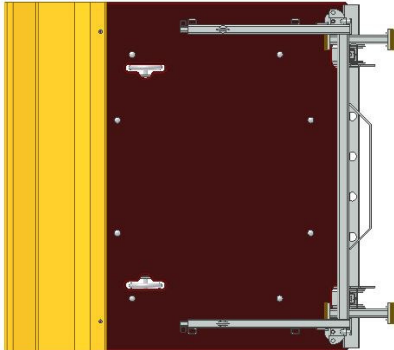

Oldalsó védőkorlát bal és jobb	Leírás	Instrukció	Fizetési kondíciók	Típus
	<p>Oldalsó védőkorlát deformálódott</p> <ul style="list-style-type: none"> ■ > 5 mm 			
	<p>Láblemez deformálódott, megtört</p>	 116050		
	<p>Csap sérült, hiányzik</p>	 117956 (csap) 114288 (rugó) 722930 (hasított ék)	 088192	

PERI Bérleti kritériumok

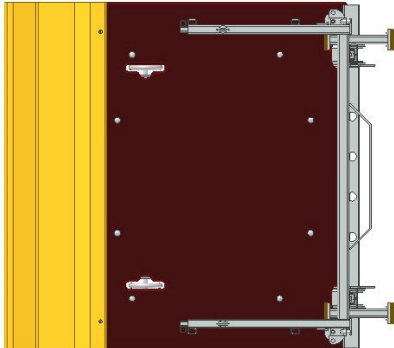
MAXIMO



Járófelület	Leírás	Instrukció	Fizetési kondíciók	Típus
	Felület kopott	 116088 (240x100) 116089 (120x100)		
	Járófelület erőszakos hatás miatt sérült	 116088 (240x100) 116089 (120x100)	 088082 088078	

PERI Bérleti kritériumok

MAXIMO



Felület	Leírás	Instrukció	Fizetési kondíciók	Típus
	Porvédő gumi vágott, szakadt	 114600 (240x100) 116390 (120x100)	 088095 088094	
	Csatlakozó merevítő elgörbült ■ > 5 mm		 088089	

PERI Bérleti kritériumok

MAXIMO



Munkaállvány MXP (115939; 115940)

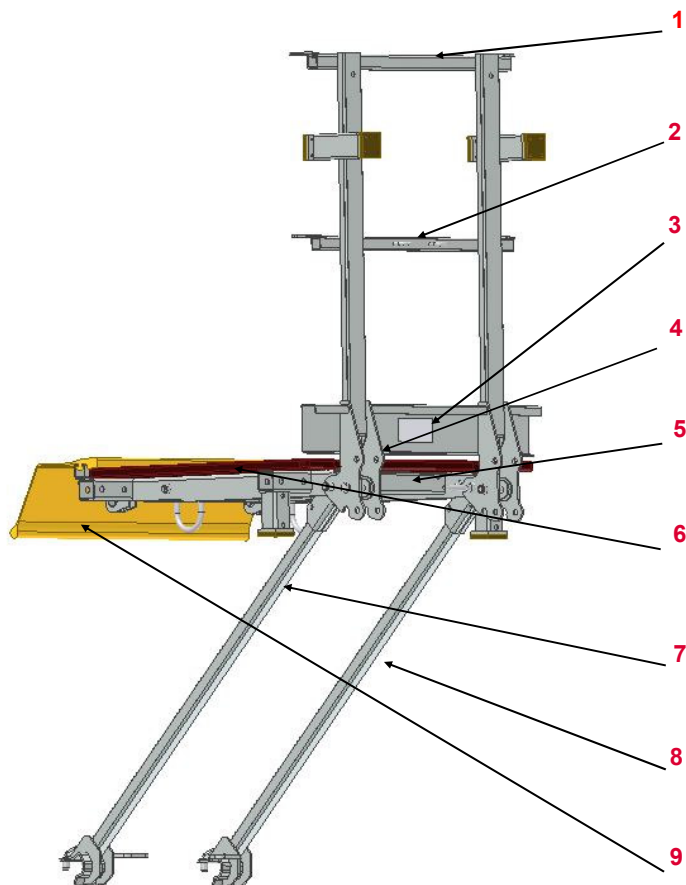

Sorszám	Megnevezés	Cikkszám MXP 90	Cikkszám MXP 72
---------	------------	-----------------	-----------------

1	Korlát	116244	116558
2	Merevítő konzol		
3	Láblemez	116242	116556
4	Csukló	116618	116618
5	Merevítő borda	116239	116553
6	Rétegelt lemez MXP	116245	116559
7	Csatlakozó merevítő bal	116012	116012
8	Csatlakozó merevítő jobb	116015	116015
9	Porvédő gumi	116091	116547

Felület	Leírás	Instrukció	Fizetési kondíciók	Típus
---------	--------	------------	--------------------	-------

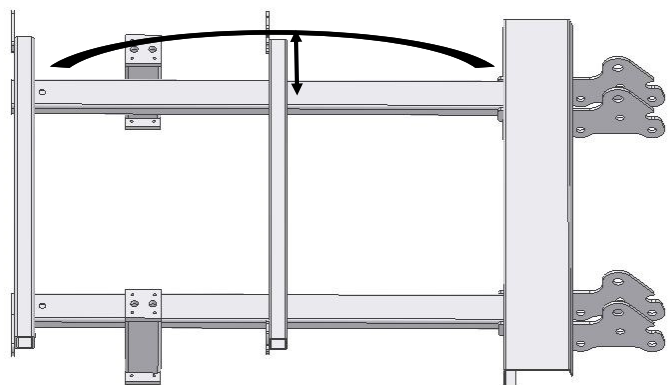

Korlát deformálódott

- ≤ 5 mm
- Vagy > 5 mm



116244 (MXP 90)
116658 (MXP 72)



088084
088087

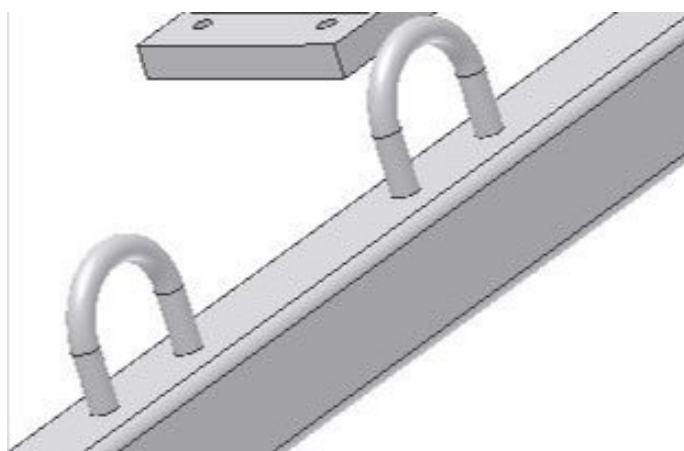

Konzol deformálódott

- Hegesztés sérülése nélkül
- Hegesztés sérülésével











088244



PERI Bérleti kritériumok

MAXIMO



Felület	Leírás	Instrukció	Fizetési kondíciók	Típus
	Láblemez deformálódott		 088244	
	Láblemezen lévő lyukak deformálódtak, szakadtak	 116242 (90x100) 116556 (72x100)		

PERI Bérleti kritériumok

MAXIMO









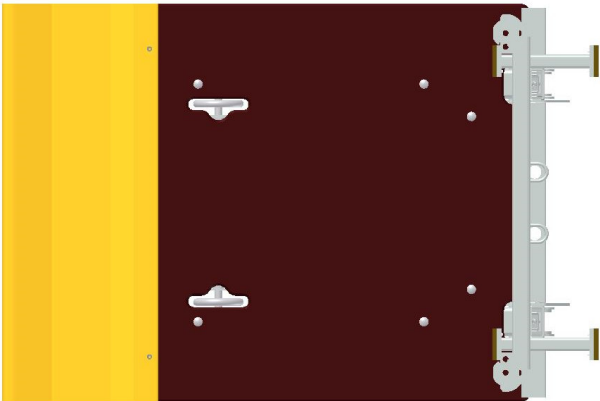

Felület	Leírás	Instrukció	Fizetési kondíciók	Típus
	Csukló deformálódott			
	■ ≤ 5 mm			
	■ Vagy > 5 mm	 116618		

PERI Bérleti kritériumok

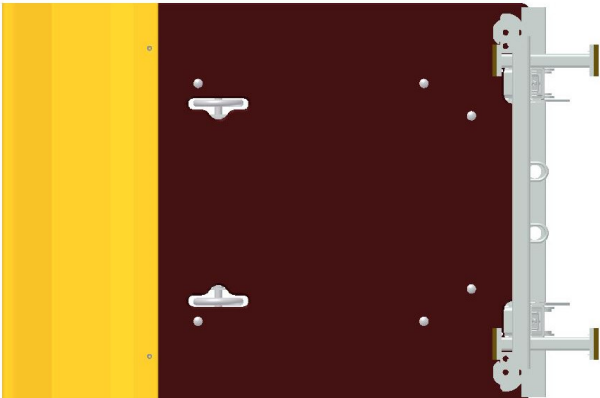
MAXIMO



Rétegelt lemez	Leírás	Instrukció	Fizetési kondíciók	Típus
	Felület kopott	 116245 (90x100) 116559 (72x100)		
	Erőszakor hatás miatt sérült	 116245 (90x100) 116559 (72x100)	 088077 088081	

PERI Bérleti kritériumok

MAXIMO



Felület	Leírás	Instrukció	Fizetési kondíciók	Típus
	Porvédő gumi vágott, szakadt	 116091 (90x100) 116547 (72x100)	 088093 088096	
	Csatlakozó merevítő elgörbült ■ > 5 mm	 116012 (bal) 116015 (jobb)	 088089	

PERI Bérleti kritériumok

MAXIMO



Munkaállvány MXK

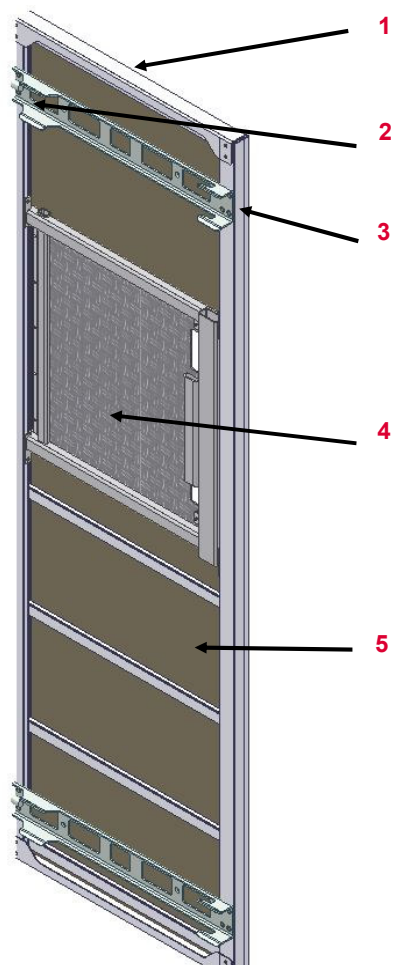











Sorszám	Megnevezés	Cikkszám
1	Rövid oldalprofil	127007
2	Vezető csap	126751
3	Heveder	126745
4	Ajtó	128720
5	Járófelület	

Megnevezés	Cikkszám
Állványfedélzet MXK 240 Ajtóval	128740
Állványfedélzet MXK (Acél) Ajtóval	128812
Állványfedélzet MXK 240	126463
Állványfedélzet MXK 120	125693
Állványfedélzet MXK 90	126927
Állványfedélzet MXK (Acél)	128310
Állványfedélzet MXK (Acél)	128311
Állványfedélzet MXK (Acél)	128312

PERI Bérleti kritériumok

MAXIMO























Munkaállvány MXK	Leírás	Instrukció	Fizetési kondíciók	Típus
	<p>Rétegelt lemez</p> <ul style="list-style-type: none"> ■ Kopott ■ Erőszakos hatás miatt sérült 	<p>Kopott: </p> <p>Sérült: </p>	<p>Kopott: </p> <p>Sérült: </p>	<p>Kopott: </p> <p>Sérült: </p>
	<p>Ajtó törött</p>	<p></p>	<p></p>	<p></p>

PERI Bérleti kritériumok

MAXIMO











Munkaállvány MXK	Leírás	Instrukció	Fizetési kondíciók	Típus
	Vezető csap deformálódott			
	■ Ha lehetséges			
	■ Ha nem lehetséges			
	■ Vagy repedés az anyagban			
	Heveder deformálódott			
	■ Ha lehetséges			
	■ Ha nem lehetséges			
	■ Vagy repedés az anyagban			

PERI Bérleti kritériumok

MAXIMO



Munkaállvány MXK	Leírás	Instrukció	Fizetési kondíciók	Típus
	Rövid oldalprofil sérült			
	Állvány elgörbült ■ > 5 mm			

PERI Bérleti kritériumok

MAXIMO



Közbenső állvány (126541)

Sorszám	Megnevezés	Cikkszám
---------	------------	----------

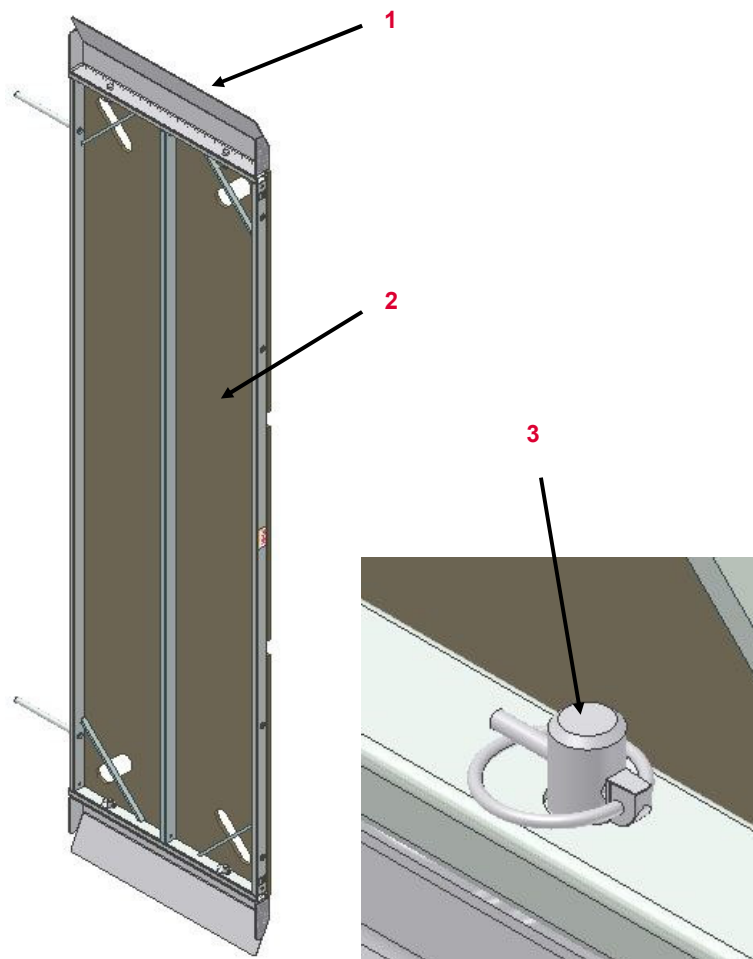

1	Átjáró	128846
2	Felület	128856
3	Sasszeg	127005

Közbenső állvány (126541)	Leírás	Instrukció	Fizetési kondíciók	Típus
	Átjáró deformálódott <ul style="list-style-type: none"> ■ Ha lehetséges 			
	<ul style="list-style-type: none"> ■ Ha nem lehetséges 	 128846 (Átjáró) 117285 (Szegecs)		
	Felület <ul style="list-style-type: none"> ■ Kopott 			
	<ul style="list-style-type: none"> ■ Vagy erőszakos hatás miatt sérült 			
	Sasszeg <ul style="list-style-type: none"> ■ Hiányzik 	 127005 (Sasszeg)		
	<ul style="list-style-type: none"> ■ Vagy sérült 	 127005 (Sasszeg)		

PERI Bérleti kritériumok

MAXIMO



Betonozó konzol MXK (126356)

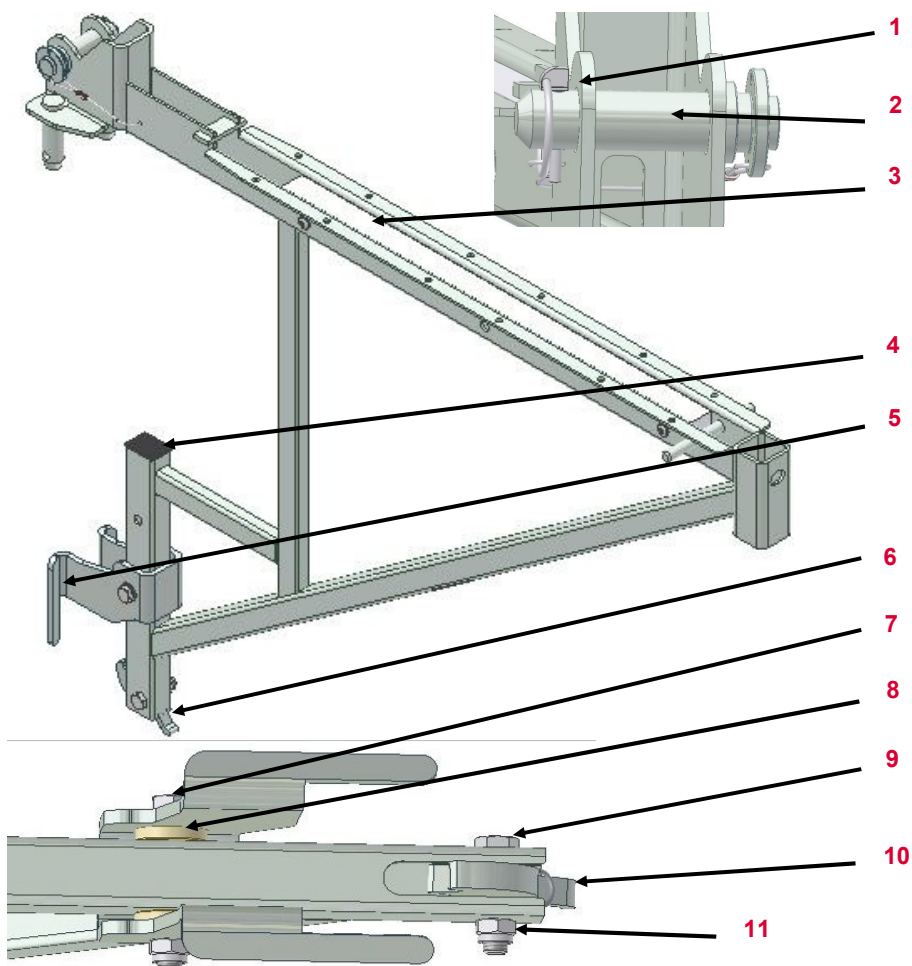













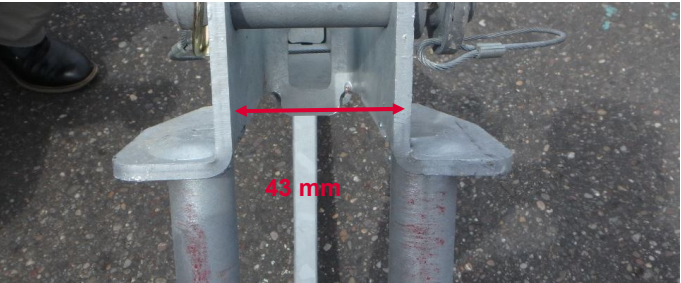

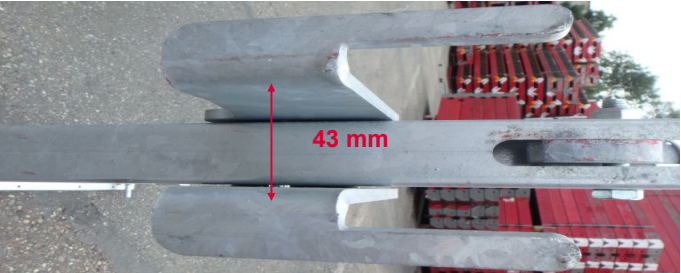

Sorszám	Megnevezés	Cikkszám
1	Sasszeg	127005
2	Biztosító csap	126730
3	Szegelő elem MXK 580	126819
4	Műanyag kupak	128592
5	Csatlakozó fej alsó	126728
6	Horog	126732
7	Csavar M 10x70	128356
8	Alátét	128621
9	Csavar M 10x45	104692
10	Rugó	127004
11	Anyá M 10	780356

PERI Bérleti kritériumok

MAXIMO



















Betonzó konzol	Leírás	Instrukció	Fizetési kondíciók	Típus
	<p>Szegelő elem kopott</p>	 126819		
	<p>Csatlakozó fej (felső) deformálódott</p> <ul style="list-style-type: none"> ■ > 43.5 mm 			
	<ul style="list-style-type: none"> ■ Vagy < 42 mm 			
	<p>Csatlakozó fej (alsó) deformálódott</p> <ul style="list-style-type: none"> ■ > 43.5 mm 			
	<ul style="list-style-type: none"> ■ Vagy < 42 mm 			

PERI Bérleti kritériumok

MAXIMO



Betonozó konzol	Leírás	Instrukció	Fizetési kondíciók	Típus
	Horog törött	 126732		
	Rugó <ul style="list-style-type: none"> ■ Törött ■ Vagy kopott 	 127004  127004	 	 
	Sodronykötél	 127303		
	<ul style="list-style-type: none"> ■ Hiányzik ■ Vagy sérült 	 127303		

PERI Bérleti kritériumok

MAXIMO



Betonozó konzol MXK-RS (126540)

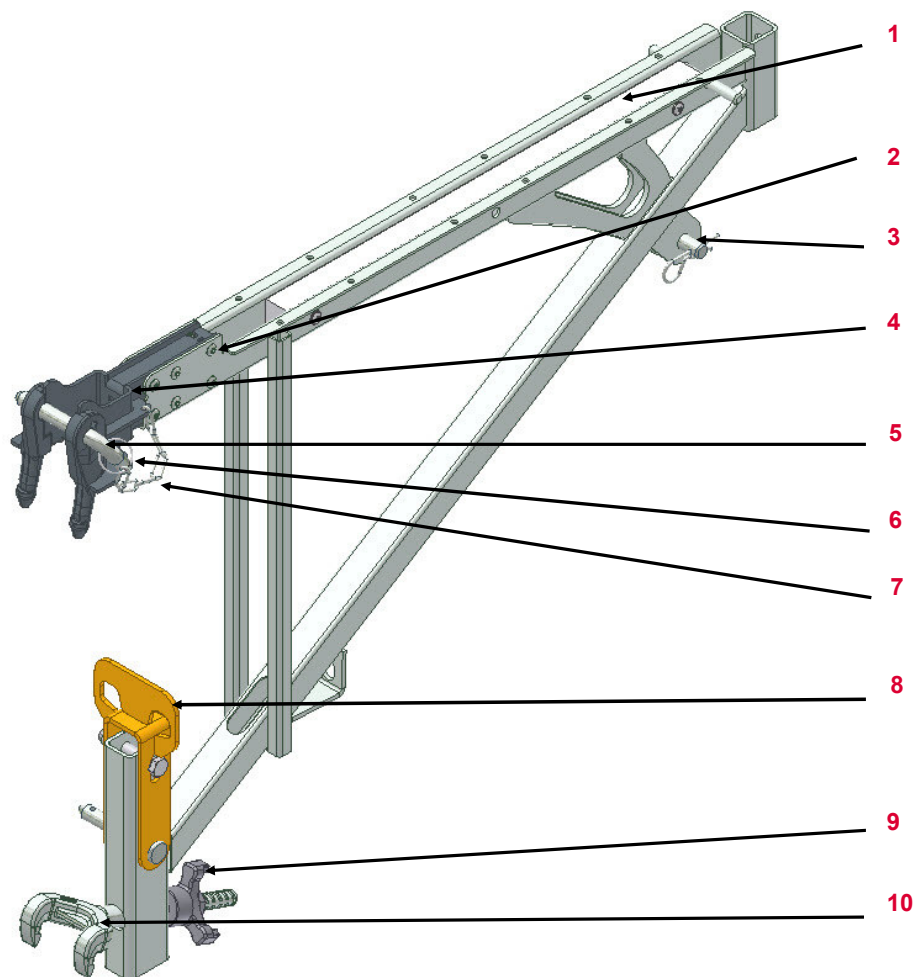









Sorszám	Megnevezés	Cikkszám
1	Szegelő elem	126819
2	Szegecs 6,5x12,5	130151
3	Csap 16x42	027170
4	Csatlakozó fej	130280
5	Csap D16	127406
6	Lánc gyűrű	710929
7	Lánc	724152
8	Feszítő retesz	127411
9	Háromszárnyú anya	030190
10	Horog MAR	124936

PERI Bérleti kritériumok

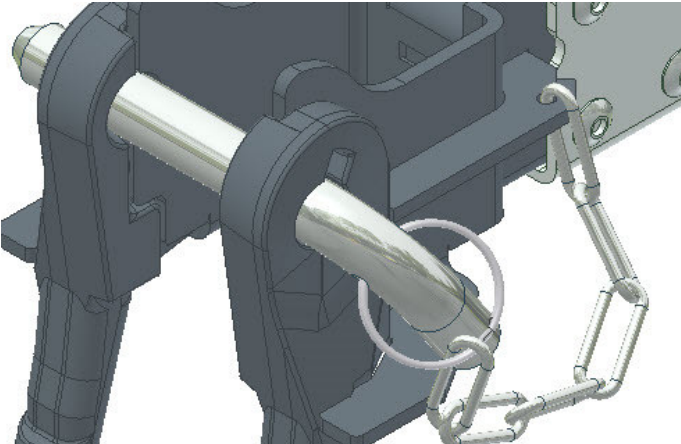
MAXIMO



















Betonozó konzol	Leírás	Instrukció	Fizetési kondíciók	Típus
	Csatlakozó fej Feszítő retesz deformálódott			
	Hiányzó alkatrészek			









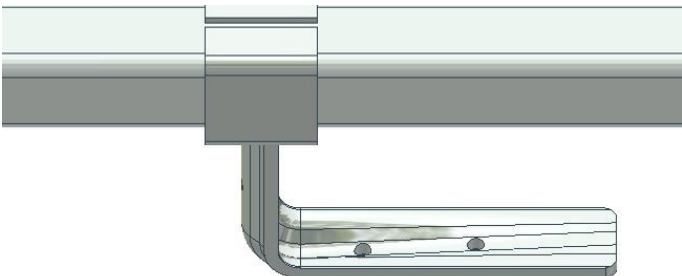
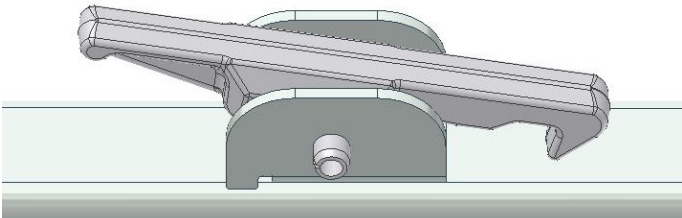







PERI Bérleti kritériumok

MAXIMO

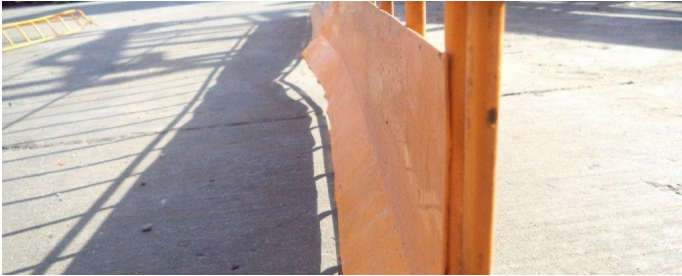

Végkorlát MXK (126357)	Leírás	Instrukció	Fizetési kondíciók	Típus
	<p>Ék</p> <ul style="list-style-type: none"> ■ Hiányzik 			
	<ul style="list-style-type: none"> ■ Vagy deformálódott (Repedés az anyagban) 			
	<p>Láblemez deformálódott</p>			
	<p>Zsanér deformálódott</p>			

















Védőkorlát MXK (126360)	Leírás	Instrukció	Fizetési kondíciók	Típus
	<p>Deformálódott</p> <ul style="list-style-type: none"> ■ > 10 mm 			
	<p>Lábdeszka rögzítő fül</p> <ul style="list-style-type: none"> ■ Hiányzik 			
	<ul style="list-style-type: none"> ■ Vagy erőszakos hatás miatt sérült 			
	<p>Biztosító horog</p> <ul style="list-style-type: none"> ■ Hiányzik 	710418 (Biztosító horog) 710420 (Rugó) 724567 (Hasított ék)		
	<ul style="list-style-type: none"> ■ Vagy erőszakos hatás miatt sérült 	710418 (Biztosító horog) 710420 (Rugó) 724567 (Hasított ék)		

Rácsos korlát (126371; 126376;126381)	Leírás	Instrukció	Fizetési kondíciók	Típus
	Rúd eltört		 088072	
	■ Deformálódott > 15 mm			
	■ Vagy megtört			
	Láblemez deformálódott			
	■ Ha lehetséges		 088244	
	■ Vagy ha nem lehetséges			

PERI Bérleti kritériumok

MAXIMO



Létra (115915; 114871)	Leírás	Instrukció	Fizetési kondíciók	Típus
	Cső rögzítő <ul style="list-style-type: none"> ■ Hiányzik 	 123480	 088007	
	<ul style="list-style-type: none"> ■ Vagy erőszakos hatás miatt sérült 	 123480	 088007	
	Létrafok deformálódott <ul style="list-style-type: none"> ■ Ha lehetséges 			
	<ul style="list-style-type: none"> ■ Ha nem lehetséges 			
	<ul style="list-style-type: none"> ■ Vagy repedés a hegesztésben 			

PERI Bérleti kritériumok







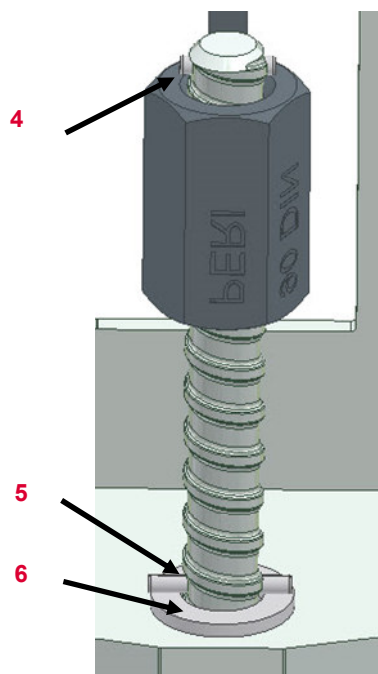
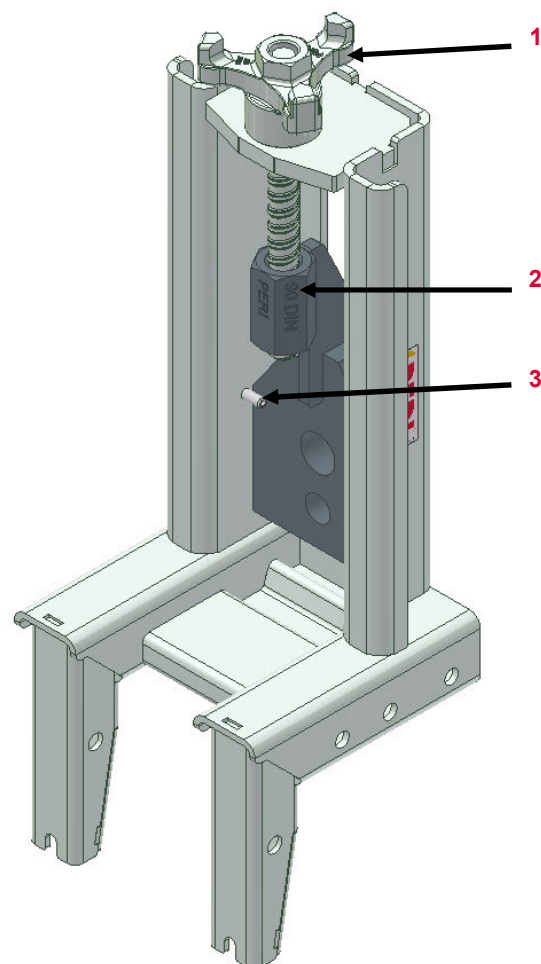



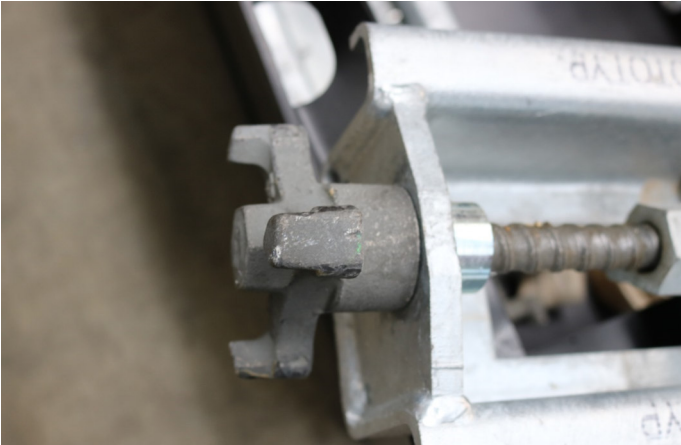

MAXIMO

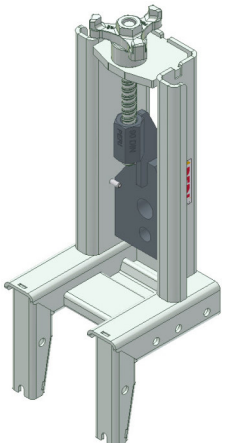

Falzsalu tartó konzol MX WK (135327)



Sorszám	Megnevezés	Cikkszám
1	Rúd anyával	135314
2	Fali konzol	
3	Hasított ék 6.0x18	710910
4	Hasított ék 4.0x20	722930
5	Hasított ék 4.0x30	113790
6	Alátét	724337

Falzsalu tartó konzol	Leírás	Instrukció	Fizetési kondíciók	Típus
	Alkatrészek <ul style="list-style-type: none"> ■ Hiányoznak 			
	<ul style="list-style-type: none"> ■ Vagy erőszakos hatás miatt sérült 			
	Deformálódott <ul style="list-style-type: none"> ■ Ha lehetséges 			
	<ul style="list-style-type: none"> ■ Ha nem lehetséges 			

Csúszó egység MX WK (135282)	Leírás	Instrukció	Fizetési kondíciók	Típus
------------------------------	--------	------------	--------------------	-------

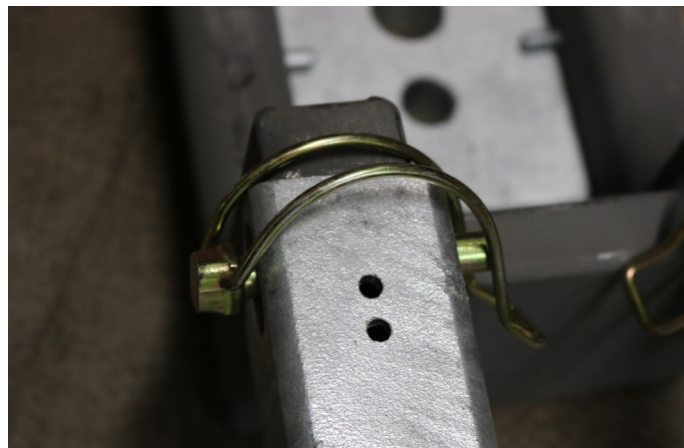

Cső biztosító

- Hiányzik
- Vagy erőszakos hatás miatt sérült



710914
123480



710914
123480



Deformáció

- Ha lehetséges
- Ha nem lehetséges



PERI Bérleti kritériumok







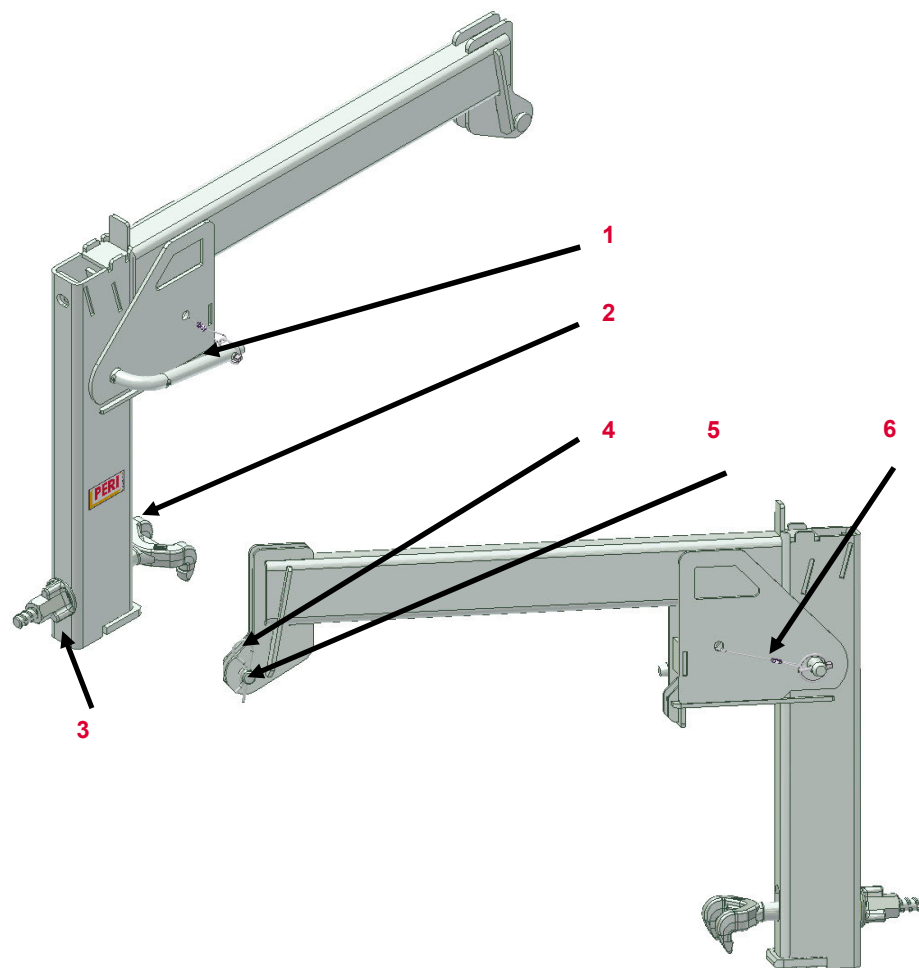



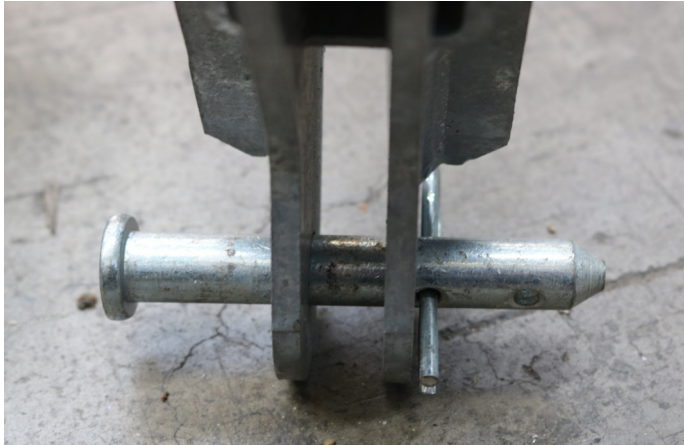

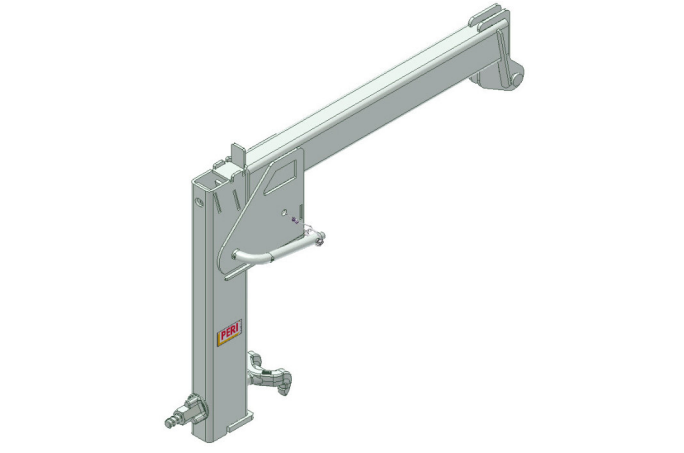

MAXIMO



Konzol csatlakozó (134623)



Sorszám	Megnevezés	Cikkszám
1	Csap RS 1000	715949
2	Horog MAR	124936
3	Bütykös anya	127005
4	Sasszeg	018060
5	Csap	027170
6	Acélsodrony	127303

Konzol csatlakozó	Leírás	Instrukció	Fizetési kondíciók	Típus
	<p>Hiányzó alkatrészek</p>			
	<p>Deformáció</p> <ul style="list-style-type: none"> ■ Ha lehetséges ■ Ha nem lehetséges, és cserélhető ■ Vagy ha nem lehetséges 	  	  	  

PERI Bérleti kritériumok

MAXIMO



Kapocs MX VS (134321)	Leírás	Instrukció	Fizetési kondíciók	Típus
-----------------------	--------	------------	--------------------	-------

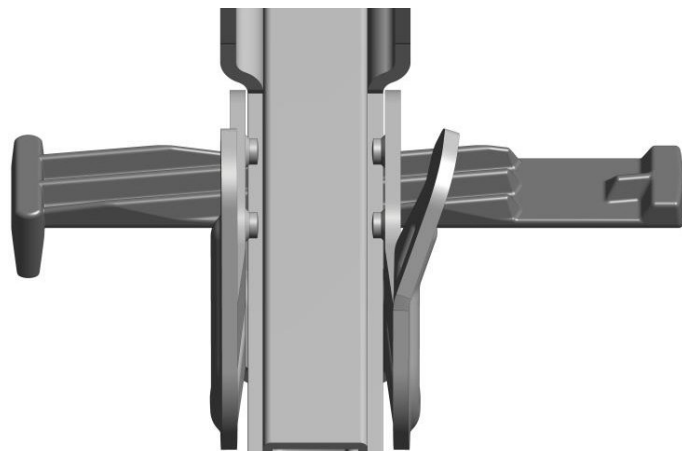

Karom deformálódott













Alkatrészek szétestek



PERI Bérleti kritériumok

MAXIMO



Szerelő rúd MX VS (134337)	Leírás	Instrukció	Fizetési kondíciók	Típus
	Alkatrészek <ul style="list-style-type: none"> ■ Hiányoznak ■ Vagy erő hatására sérültek 	 <ul style="list-style-type: none"> 134333 (Adapter BFD) 134336 (Határoló) 126908 (Csavar) 711071 (Anyá)  <ul style="list-style-type: none"> 134333 (Adapter BFD) 134336 (Határoló) 126908 (Csavar) 711071 (Anyá) 	 	 
	Lemezek deformálódtak			

PERI Bérleti kritériumok

MAXIMO



Speciális szárnyasanya (135167)	Leírás	Instrukció	Fizetési kondíciók	Típus
	Alkatrészek <ul style="list-style-type: none">■ Hiányoznak■ Vagy erő miatt sérült	 	 	
	Hüvely deformálódott			

PERI Bérleti kritériumok

MAXIMO





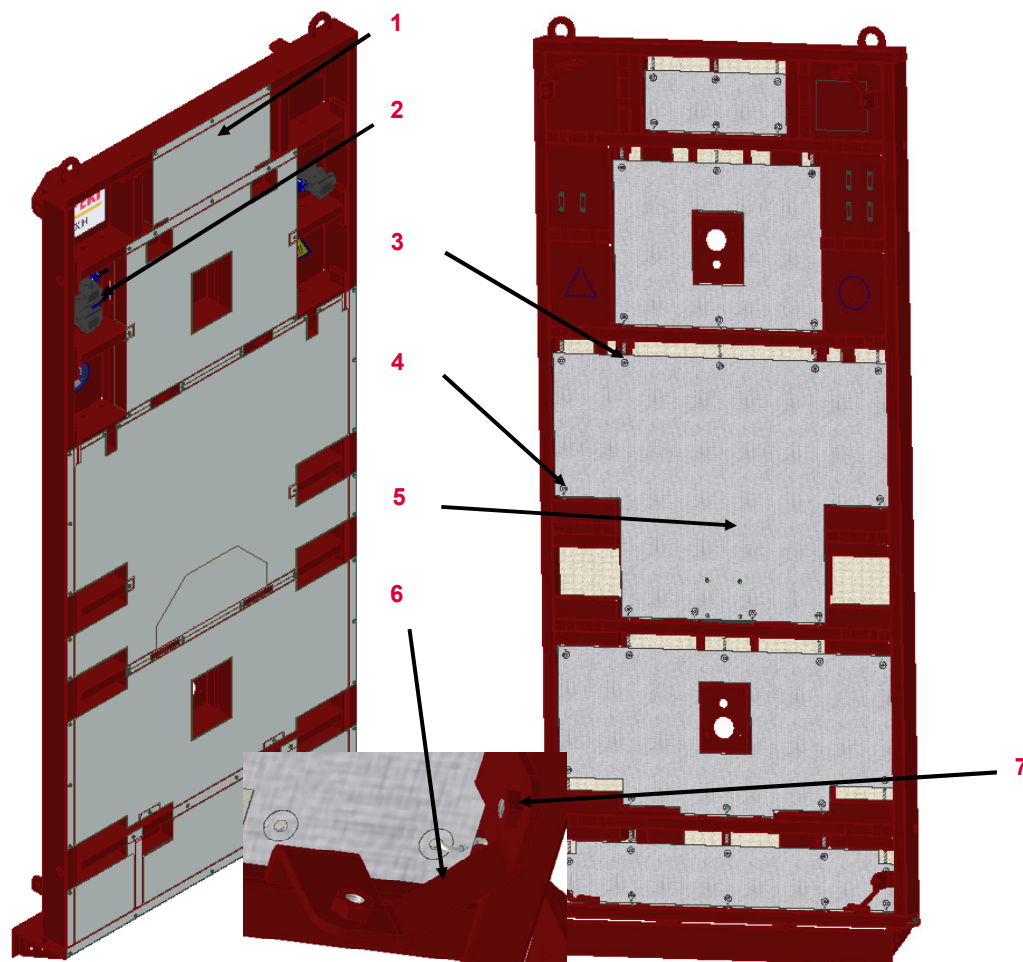









Fűtött panel MXH



Sorszám	Megnevezés	Cikkszám
1	Fedőlap	
2	Csatlakozó	
3	Feszítő rugó	113065
4	S- Horog	113066
5	Fűtő elem	
6	Lemez	129161
7	Hegeszthető anya	125662













Megnevezés	Cikkszám
Fűtött panel MXH 270x240	129132
Fűtött panel MXH 270x120	129133
Fűtött panel MXH 120x240	129370
Fűtött panel MXH 120x120	129375
Fűtött panel MXH 60x240	129134
Fűtött panel MXH 60x120	129135













Fűtött panel MXH	Leírás	Instrukció	Fizetési kondíciók	Típus
	Fedőlap kiáll	 Helyezzen be egy csavart (129242)		
	Fedőlap behajlott			
	Sérülés a fedőlapon ■ Fűtőelem károsodása nélkül			

PERI Bérleti kritériumok

MAXIMO



Fűtött panel MXH	Leírás	Instrukció	Fizetési kondíciók	Típus
	Hatszögletű aljzat szennyeződéssel telített			
	Csavar deformálódott törött	 129242		
	Fedőlap szennyeződéssel telített			









Fűtött panel MXH	Leírás	Instrukció	Fizetési kondíciók	Típus
	Menet sérült <ul style="list-style-type: none"> ■ Ha lehetséges 			
	<ul style="list-style-type: none"> ■ Ha nem lehetséges 		125662 (Hegeszthető anya)	
	Csatlakozó lemez deformálódott <ul style="list-style-type: none"> ■ Ha lehetséges 			
	<ul style="list-style-type: none"> ■ Ha nem lehetséges 		126919 (Lemez) 125662 (Hegeszthető anya)	

Fűtött panel MXH	Leírás	Instrukció	Fizetési kondíciók	Típus
	Fűtő elem sérült <ul style="list-style-type: none"> ■ Erő hatására sérült ■ Vagy elhasználódott (kopott) 	 Szakképzett villanyszerelő végezheti	 	
	Csatlakozó dugó sérült	 Szakképzett villanyszerelő végezheti		

PERI Bérleti kritériumok

MAXIMO



Fűtött panel MXH	Leírás	Instrukció	Fizetési kondíciók	Típus
	Csatlakozó fedele eltört hiányzik			
	Csatlakozás laza	 Meghúzás (különben beázás veszély)		

PERI Bérleti kritériumok

MAXIMO



Csatlakozó RS MXH (129136)	Leírás	Instrukció	Fizetési kondíciók	Típus
----------------------------	--------	------------	--------------------	-------



Csatlakozó deformálódott



Szárnyas anya

■ Nem mozgatható



030190



■ Vagy eltört a szárnya





















030190



PERI Bérleti kritériumok

Magyarázat



Ikon	Jelentés	Ikon	Jelentés	Ikon	Jelentés
	Nem Ok– Selejtezendő		Ügyfélnek számlázandó		Optikai kár
	OK– marad a bérleti parkban		Nincs számlázás		Funkcionális sérülés
	Selejt anyag– biztonsági okokból az anyagot tilos kiadni		Anyagot levágni		Funkcionális sérülés— anyag kiadása nem engedélyezett
	Javítás az előírások szerint		Anyagot megjelölni		Statikai sérülés— anyag kiadása nem engedélyezett
	Hideg egyengetés– utána a varratokat és a környékét ellenőrizni kell		Sérült anyag cseréje		
	Javítás gazdaságosság függvényében		Hiányzó anyag pótlása		
	Megtisztítani az anyagot		Figyelem feszültség		