

PERI Bérleti kritériumok

QUATTRO Pillérzsaluzat



Kapcsolat

PERI kft,
zsaluzatok, állványzatok,
mérnöki szolgáltatás

H-1181 Budapest
Zádor u. 9.
Tel.: +36-1-296-09-60
www.peri.hu

Tartalom	Oldal
Zsaluhéj	2
Keretváz	6
Betonozó állvány	9
Daruemelő betonozó podesz	13
Létra 180/6	16
QUATTRO áthelyező kerék	17
QUATTRO feszítőkészlet	18
QUATTRO támaszkapcsoló	19
QUATTRO tétracsatlakozó	20

Változás	Dátum ü	Oldal
Új verzió	10/2015 O.L.	

PERI Bérleti kritériumok

QUATTRO Pillérzsaluzat



QUATTRO

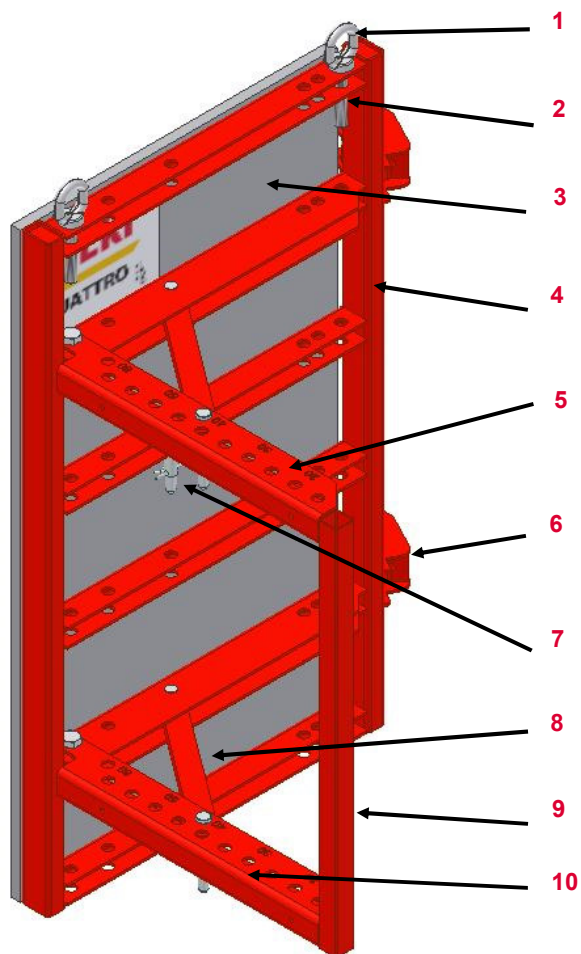















Sorszám	Megnevezés	Cikkszám
1	Szemcsavar	724812
2	Hatl.anya M20	710045
3	SABO zsaluhéj	
4	Fém keretváz	
5	Támasztó merevítőkeret	
6	QE csatlakozófej	724447
7	Csap	105400
8	Támasztó merevítőelem	725568 724543 724450
9	Tám.,merevítőkeret profil	
10	QE lyukheveder	

Megnevezés	Cikkszám
QUATTRO Elem QES 125	109924
QUATTRO Elem QES 275	109925
QUATTRO Elem QES 350	109926
QUATTRO Elem QES 50	109923

PERI Bérleti kritériumok

QUATTRO Pillérzsaluzat











Zsaluhéj	Leírás	Instrukció	Fizetési kondíciók	Típus
	17.20.01 Szeg lyukak			
	<ul style="list-style-type: none"> ■ Szögelés előlről 	 Sorjázás kaparóval		
	<ul style="list-style-type: none"> ■ Vagy szegelés hátulról 			
	17.20.02 Lyukak			
	<ul style="list-style-type: none"> ■ ≤ 35 mm 			
	<ul style="list-style-type: none"> ■ Vagy > 35 mm 	 <ul style="list-style-type: none"> SABO 500 mm (052164) SABO 1250 mm (052165) SABO 2750 mm (052166) SABO 3500 mm (052167) 	 <ul style="list-style-type: none"> 084223 084222 084221 084220 	

PERI Bérleti kritériumok

QUATTRO Pillérzsaluzat











Zsaluhéj	Leírás	Instrukció	Fizetési kondíciók	Típus
	17.20.03 Bevágás / karcolások ■ > 1 mm			
	17.20.04 Szegély sérülések ■ > 5 mm			

PERI Bérleti kritériumok

QUATTRO Pillérzsaluzat









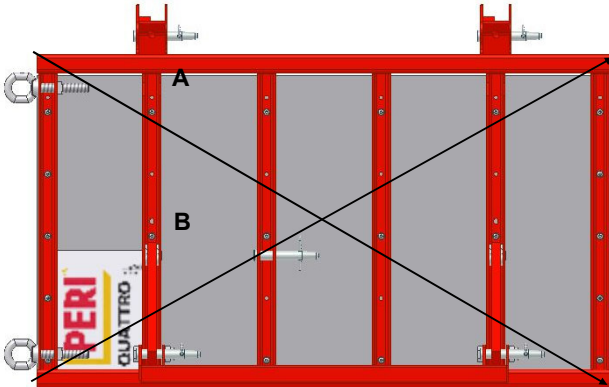

Zsaluhéj	Leírás	Instrukció	Fizetési kondíciók	Típus
	17.20.05 Hőhatás okozta sérülés	 SABO 500 mm (052164) SABO 1250 mm (052165) SABO 2750 mm (052166) SABO 3500 mm (052167)	 084223 084222 084221 084220	
	17.20.06 Nem eltávolítható szennyeződés	 SABO 500 mm (052164) SABO 1250 mm (052165) SABO 2750 mm (052166) SABO 3500 mm (052167)	 084223 084222 084221 084220	

PERI Bérleti kritériumok

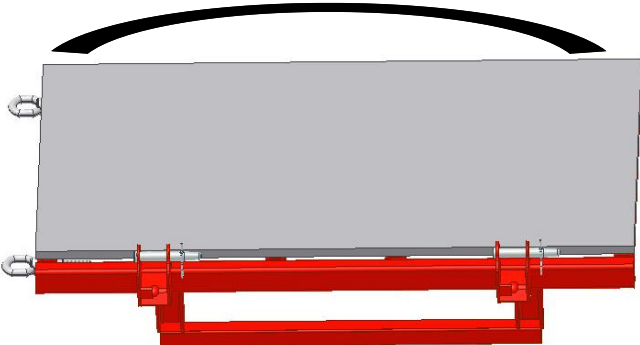
QUATTRO Pillérzsaluzat



Keretváz	Leírás	Instrukció	Fizetési kondíciók	Típus
	<p>17.20.07 Keretváz nem szimmetrikus</p> <ul style="list-style-type: none">■ Eltérés A és B > 10 mm			
	<p>17.20.08 Keretváz deformálódott</p> <ul style="list-style-type: none">■ > 6 mm			

PERI Bérleti kritériumok

QUATTRO Pillérzsaluzat



















Keretváz	Leírás	Instrukció	Fizetési kondíciók	Típus
<p>QE 125 Rahmen verbogen</p>	17.20.09 Borda deformálódott <ul style="list-style-type: none"> ■ Ha lehetséges 		088244	
	<ul style="list-style-type: none"> ■ Vagy ha nem lehetséges 		0883589	
	17.20.10 Talplemez deformálódott <ul style="list-style-type: none"> ■ Ha lehetséges 		088244	
	<ul style="list-style-type: none"> ■ Vagy ha nem lehetséges 		088292	

PERI Bérleti kritériumok

QUATTRO Pillérzsaluzat



Keretváz	Leírás	Instrukció	Fizetési kondíciók	Típus	
	17.20.11 QE csatlakozófej deformálódott				
	<ul style="list-style-type: none"> ■ Ha lehetséges 		 088244		
	<ul style="list-style-type: none"> ■ Vagy ha nem lehetséges 				
	17.20.12 Támasztó merevítőkeret				
	<ul style="list-style-type: none"> ■ Támasztó merevítőkeret rögzítő lyukak deformálódtak 		Tám.m.keret QE 125 (724527) Tám.m.keret QE 275 (724537) Tám.m.keret QE 350 (104646)	 088350 088354 088353	
	<ul style="list-style-type: none"> ■ Vagy a merevítő deformálódott 		Tám.m.keret QE 125 (724527) Tám.m.keret QE 275 (724537) Tám.m.keret QE 350 (104646)	 088350 088354 088353	
	<ul style="list-style-type: none"> ■ Vagy a támasztó merevítőkeret profilja deformálódott 		Tám.m.keret QE 125 (724527) Tám.m.keret QE 275 (724537) Tám.m.keret QE 350 (104646)	 088350 088354 088353	

PERI Bérleti kritériumok

QUATTRO Pillérzsaluzat



Betonozó állvány (037400)

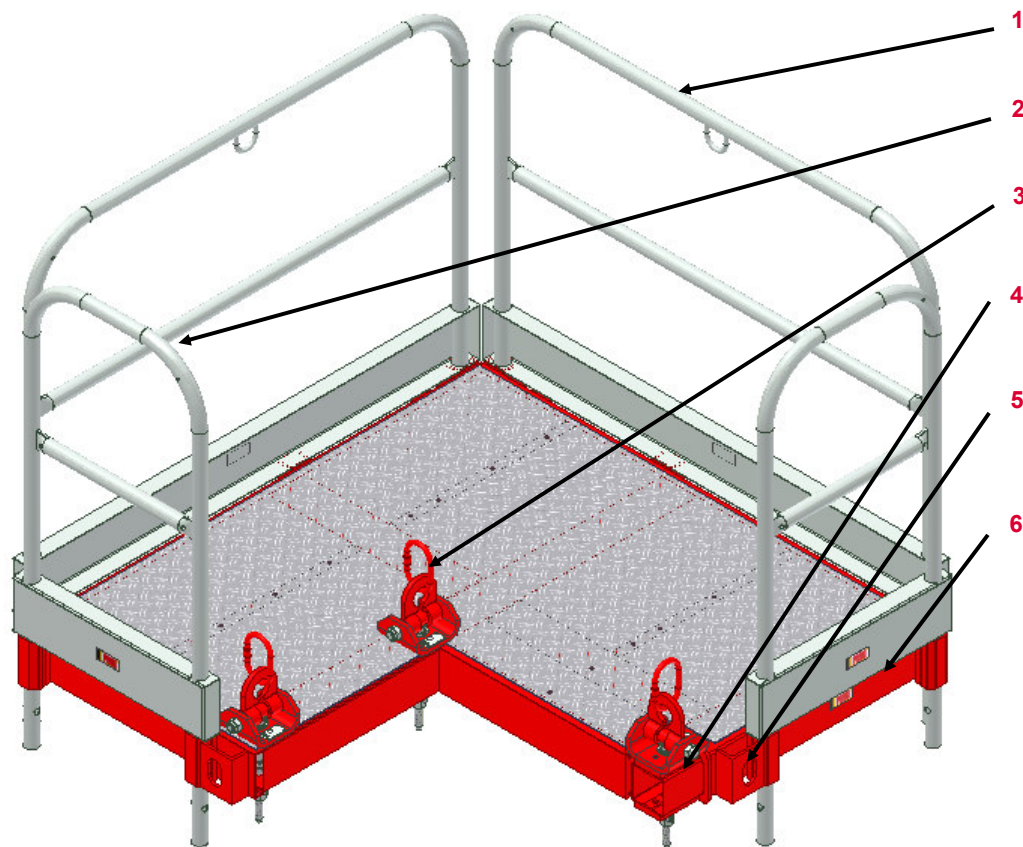

Sorszám	Megnevezés	Cikkszám
1	Védőkorlát 134	037430
2	Védőkorlát 52	037420
3	Daruemelő	037440
4	Teleszkóp cső	786108
5	Védőkorlát felfüggesztés	
6	Betonozó podesz	037410

PERI Bérleti kritériumok

QUATTRO Pillérzsaluzat



Betonozó állvány	Leírás	Instrukció	Fizetési kondíciók	Típus
	17.20.13 Védőkorlát 134 <ul style="list-style-type: none"> ■ Hegesztés szakadt 	Védőkorlát 134(037430)	088590	
	<ul style="list-style-type: none"> ■ Vagy deformálódott 	Védőkorlát 134 (037430)	088590	
	17.20.14 Védőkorlát 52 <ul style="list-style-type: none"> ■ Hegesztés szakadt 	Védőkorlát 52 (037420)	088589	
	<ul style="list-style-type: none"> ■ Vagy deformálódott 	Védőkorlát 52 (037420)	088589	

PERI Bérleti kritériumok

QUATTRO Pillérzsaluzat

















Betonozó állvány	Leírás	Instrukció	Fizetési kondíciók	Típus
	17.20.15 Teleszkóp cső <ul style="list-style-type: none"> ■ Deformálódott 	Teleszkóp cső (786108)	088582	
	<ul style="list-style-type: none"> ■ Vagy a lyukak deformálódtak 	Teleszkóp cső (786108)	088582	
	17.20.16 Lyuk a platformon <ul style="list-style-type: none"> ■ ≤ 30 mm 			
	<ul style="list-style-type: none"> ■ > 30 mm 			

PERI Bérleti kritériumok

QUATTRO Pillérzsaluzat



Betonozó állvány	Leírás	Instrukció	Fizetési kondíciók	Típus
	17.20.17 Korláttartó nagy <ul style="list-style-type: none"> ■ Deformálódott, az anyag vagy hegesztés repedése nélkül 		 088244	
	<ul style="list-style-type: none"> ■ Deformálódott, az anyag vagy a hegesztés repedésével 			
	17.20.18 Korláttartó kicsi <ul style="list-style-type: none"> ■ Deformálódott, az anyag vagy hegesztés repedése nélkül 		 088244	
	<ul style="list-style-type: none"> ■ Deformálódott, az anyag vagy a hegesztés repedésével 			

PERI Bérleti kritériumok

QUATTRO Pillérzsaluzat



Betonozó podesz daruemelő 1T (037440)

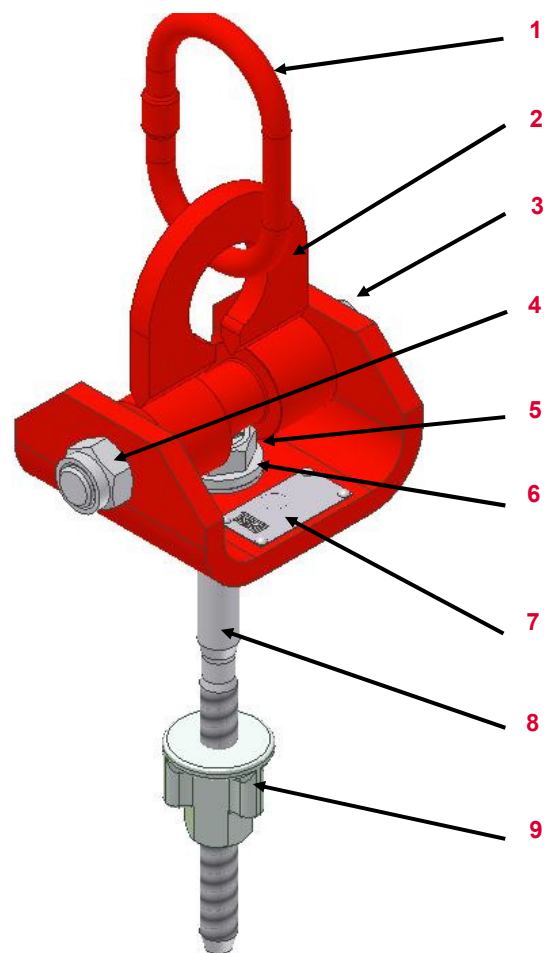















Sorszám	Megnevezés	Cikkszám
1	Daru felfüggesztés	
2	Daruszem	
3	Hatl. csavar	781051
4	Hatl. anya	781053
5	Rugós alátét	105513
6	Alátét	781016
7	Típustábla	710539
8	TRS átkötő csavar	054230
9	Bütykös anya	030130

PERI Bérleti kritériumok

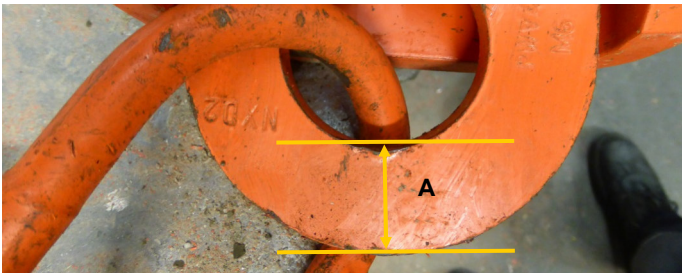
QUATTRO Pillérzsaluzat



Daruemelő	Leírás	Instrukció	Fizetési kondíciók	Típus
	17.20.19 Típusábra olvashatatlan elveszett	 Típusábra (710539)  Szegecs (767043)		
	17.20.20 Függesztő tartó <ul style="list-style-type: none"> ■ $\varnothing \leq 12,5 \text{ mm}$ 	 		
	17.20.21 Daru felfüggesztés <ul style="list-style-type: none"> ■ $A \leq 22,5 \text{ mm}$ 	 		

PERI Bérleti kritériumok

QUATTRO Pillérzsaluzat













Daruemelő	Leírás	Instrukció	Fizetési kondíciók	Típus
	17.20.22 Sérült bütykös anya	 Bütykös anya(030130)		
	17.20.23 A TRS csavar elgörbült, törött vagy vágott	 TRS átkötő csavar (054230)		
	17.20.24 A daru felfüggesztése nem mozog	 Használjon kenőanyagot		

PERI Bérleti kritériumok

QUATTRO Pillérzsaluzat













Létra 180/6 (051410)	Leírás	Instrukció	Fizetési kondíciók	Típus
	17.20.25 Létrafok deformálódott <ul style="list-style-type: none"> ■ > 3 mm 			
	17.20.26 Hegesztés szakadt <ul style="list-style-type: none"> ■ Az alapanyag deformációja nélkül ■ Vagy deformációval 	 	 	 

PERI Bérleti kritériumok

QUATTRO Pillérzsaluzat



QUATTRO áthelyező kerék (105791)	Leírás	Instrukció	Fizetési kondíciók	Típus
	<p>17.20.27 Kerék</p> <ul style="list-style-type: none"> ■ Kopott ■ Vagy erőszakos hatások által okozott sérülés 	<p> Kerék (105783)</p> <p> Kerék (105783)</p>	<p></p> <p></p>	<p></p> <p></p>
	<p>17.20.28 Fogantyú deformálódott törött</p>	<p> Fogantyú (105758) Feszítőhüvely (710683)</p>	<p></p>	<p></p>

PERI Bérleti kritériumok

QUATTRO Pillérzsaluzat



QUATTRO feszítőkészlet (037540)	Leírás	Instrukció	Fizetési kondíciók	Típus
---------------------------------	--------	------------	--------------------	-------



17.20.29 Villa deformálódott



088244



17.20.30 Szárnyas anya selejt



Szárnyas anya (724811)



PERI Bérleti kritériumok

QUATTRO Pillérzsalu



QUATTRO támaszkapcsoló (037530)

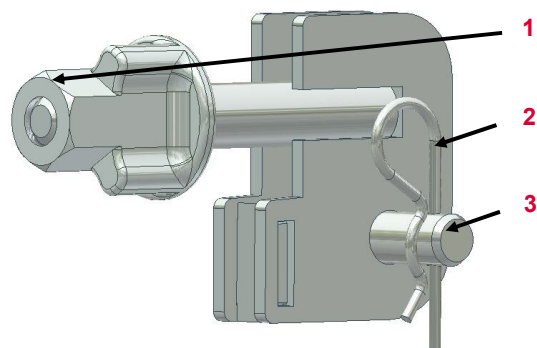

Sorszám	Megnevezés	Cikkszám
1	Bütykös anya	030130
2	Sasszeg	018060
3	Csap d16x42	027170

Sérülés	Leírás	Instrukciók	Fizetési kondíciók	Típus
---------	--------	-------------	--------------------	-------



17.20.31 Bütykös anya selejt



Bütykös anya (030130)



088429

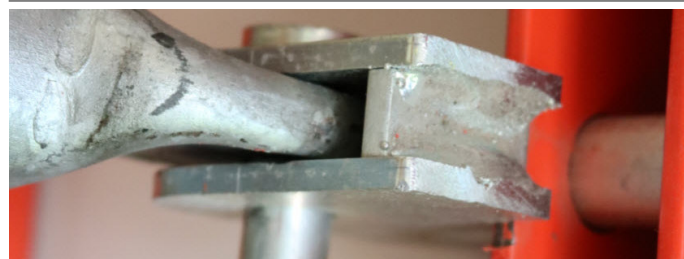

17.20.32 Deformálódott

■ Ha lehetséges



088244



■ Vagy ha nem lehetséges



PERI Bérleti kritériumok

QUATTRO Pillérzsalu



QUATTRO létracsatlakozó (103391)

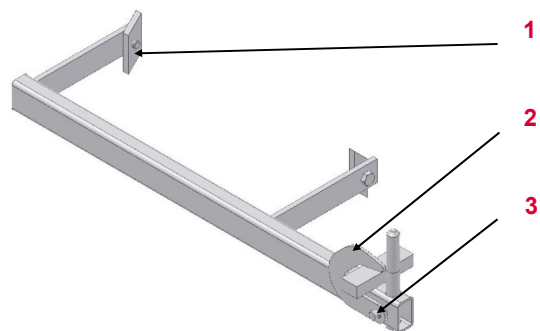

Sorszám	Megnevezés	Cikkszám
1	Szorítólemez	701763
2	Rögzítő fül	104076
3	Feszítő hüvely	780803

Sérülés	Leírás	Instrukciók	Fizetési kondíciók	Típus
---------	--------	-------------	--------------------	-------



17.20.33 Szorítólemez deformálódott | törött



Szorítólemez (701763)
Csavar (710266)



088295



17.20.34 Rögzítő fül deformálódott | törött



Rögzítő fül (104076)
Feszítő hüvely (780803)



















088291



PERI Bérleti kritériumok

Magyarázat



Ikon	Jelentés	Ikon	Jelentés	Ikon	Jelentés
	Nem OK — kicselezendő		Ügyfélnek leszámházandó		Optikai kár
	OK– marad a bérleti parkban		Nincs számlázás		Funkcionális sérülés
	Selejt anyag – biztonsági okokból az anyagot tilos kiadni		Anyagot levágni		Funkcionális sérülés — anyag kiadása nem engedélyezett
	Javítás az előírások szerint		Anyagot megjelölni		Statikai sérülés — anyag kiadása nem engedélyezett
	Hideg egyengetés — utána a varratokat és a környékét ellenőrzni kell		Sérült anyag cseréje		
	Javítás gazdaságosság függvényében		Hiányzó anyag cseréje		
	Megtisztítani az anyagot				