

# RCS Rail Climbing System

## The universal climbing construction kit for safe working at great heights

Product Brochure

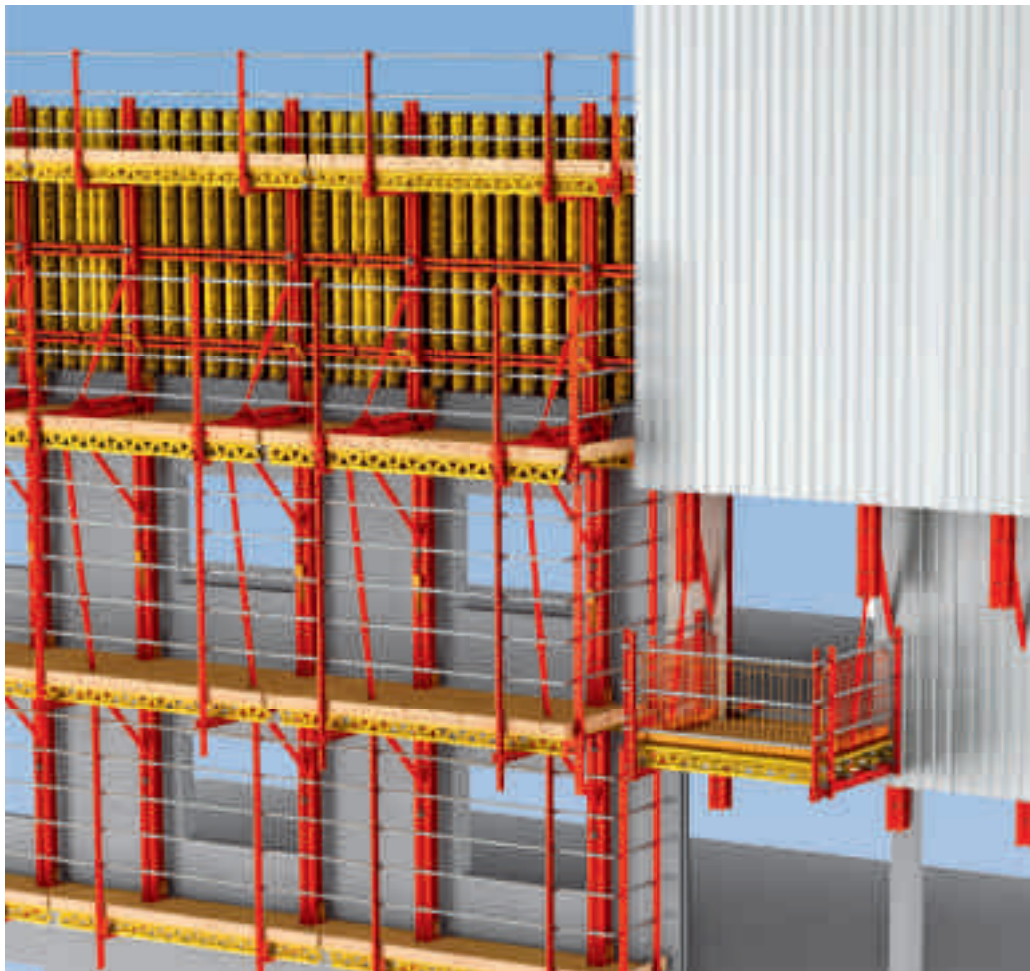

Edition 04 | 2016

**PERI GmbH**  
**Formwork Scaffolding Engineering**

Rudolf-Diesel-Strasse 19  
89264 Weissenhorn  
Germany  
Tel. +49 (0) 7309.950-0  
Fax +49 (0) 7309.951-0  
info@peri.com  
www.peri.com

**Important notes**

All current safety regulations and guidelines must be observed in those countries where our products are used.

The images shown in this brochure feature construction sites in progress. For this reason, safety and anchor details in particular cannot always be considered as conclusive or final. These are subject to the risk assessment carried out by the contractor.

In addition, computer graphics are used which are to be understood as system representations. For ensuring a better understanding, these and the detailed illustrations shown have been partially reduced to certain aspects. The safety installations which have possibly not been shown in these detailed descriptions must nevertheless be available.

The systems or items shown might not be available in every country.

Safety instructions and load specifications are to be strictly observed at all times. Separate structural calculations are required for any deviations from the standard design data.

The information contained herein is subject to technical changes in the interests of progress. Errors and typographical mistakes reserved.

# Content

## **RCS Rail Climbing System**

- 2 The universal climbing construction kit for safe working at great heights

## **Climbing formwork solutions for your projects**

- 4 Detailed planning and competent support throughout the entire project

## **RCS Climbing Formwork**

- 8 RCS C with Carriage for standard applications
- 10 The lightweight RCS CL Self-Climbing Formwork
- 12 The non-guided, crane-climbed RCS CB version
- 14 Reference projects

## **RCS P Climbing Protection Panel**

- 16 Fall protection, weather protection and advertising space all at the same time
- 18 Enclosure variants for all requirements
- 20 Reference projects

## **RCS MP Landing Platform and RCS ML Material Lifter**

- 22 Flexible solutions for moving loads with and without a crane

## **Special solutions with the RCS Rail Climbing System**

- 26 Wide range of possibilities thanks to the construction kit logic

## **RCS Anchoring**

- 28 Flexible mounting solutions for the RCS Rail Climbing System

## **RCS Self-Climbing Hydraulics**

- 30 Cost-effective climbing without use of a crane with mobile RCS Climbing Devices

- 32 Components

# RCS Rail Climbing System

## The universal climbing construction kit for safe working at great heights

**PERI RCS (Rail Climbing System) combines the advantages of different climbing systems to create one single construction kit. The rail climbing system can be used as climbing formwork as well as a climbing protection panel and can easily be adapted to meet specific site requirements.**

As climbing formwork as well as climbing protection panel, RCS is the most cost-effective solution for a wide range of projects. Through the rail guidance, the climbing procedure is fast and safe, even in windy conditions. The climbing units are moved with the crane or optionally using mobile climbing hydraulics.

In addition, the RCS components can be used for countless, site-specific solutions. In combination with components of the VARIOKIT Engineering Construction Kit, this results in e.g. landing platforms for transporting materials or optimized project-specific truss constructions.

### ■ Safe rail-guided procedure

The moving unit is connected to the building at all times by means of climbing shoes

### ■ Flexible mounting

The climbing shoe can be attached to walls as well as slab edges

### ■ Variable assembly

Due to the 125 mm hole arrangement of the climbing rails, the platforms can be optimally adapted to suit the respective storey heights

RCS C Climbing Formwork and  
RCS P Climbing Protection Panel

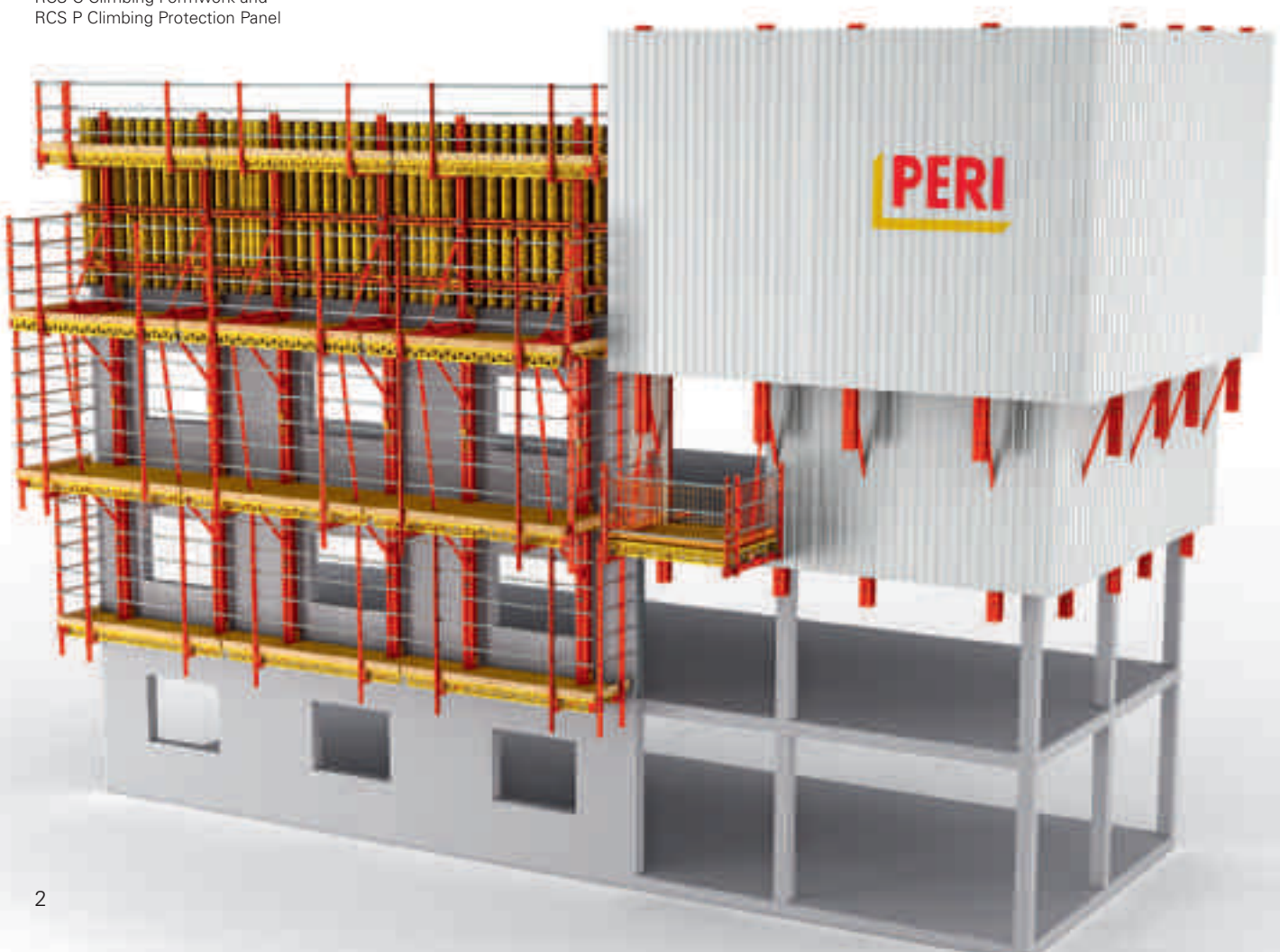



**RCS core components**

**RCS Climbing Rail**

The universal steel profile for climbing applications and as a core component in the VARIOKIT Engineering Construction Kit available in lengths from 1.48 m to 9.98 m

**RCS Climbing Shoe**

Guidance and bearing support for RCS Climbing Rails with foldable guidance skids and self-acting bearing pawl

**RCS 50 Climbing Device**

For crane-independent climbing of RCS climbing units with 5 t lifting force



**RCS as RCS C Climbing Formwork**

Rail-guided and optional self-climbing platforms with retractable wall formwork

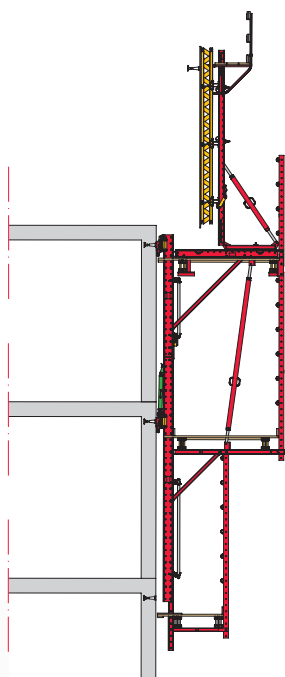

**RCS as RCS P Climbing Protection Panel**

Windshield, anti-fall protection and protection against falling objects

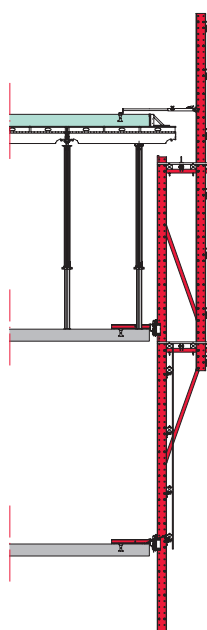

**RCS for special applications**

Here as self-climbing shaft platform with shaft internal formwork

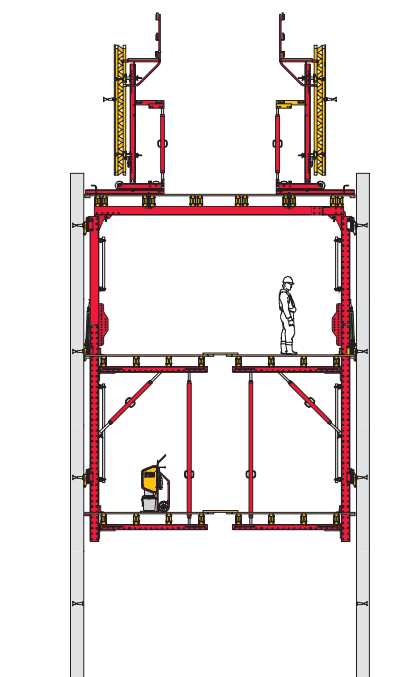

# Climbing formwork solutions for your projects

## Detailed planning and competent support throughout the entire project



**PERI Engineering stands for project-specific complete solutions comprised of efficient formwork and scaffolding systems, optimized planning and continuous support for the execution.**

Planning is teamwork: with their expert knowledge and experience from hundreds of projects, PERI engineers optimize the customized solutions for our customers.

In very close cooperation with our customers, PERI engineers plan technically and cost-effectively optimized climbing solutions. In the process, they use their extensive experience gained from a wide range of projects worldwide. The solution also includes extensive technical documentation – from detailed execution drawings through to verifiable static calculations. In addition, 3D animations can be used to simulate extremely clearly the workflows and safety concepts in advance and to ensure interference-free planning.

The 3D animation in comparison with the realized project. The clear presentation is particularly suitable for training purposes and helps with the optimization of the work processes.

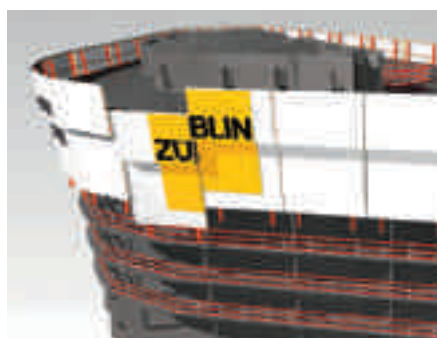



Protected by the RCS Climbing Protection Panel, the two twisted Absolute World Towers in Mississauga, Canada, were climbed upwards using regular weekly cycles – on the northern tower, even winding around the building like a spiral. Integrated landing platforms ensure simple and fast transport of materials.





# Climbing formwork solutions for your projects

## Detailed planning and competent support throughout the entire project

**We also provide the best support for cost-effective implementation of the planning – continuously from material delivery, installation and execution through to final return deliveries.**

Worldwide, over 110 logistics centres guarantee high material availability and fast delivery of materials. As the RCS system components are available in the rental park, they can be rented on a project-related basis according to specific needs. This makes RCS solutions extremely economical for our customers.

On request, our supervisors will provide the briefing regarding the operation and handling of the PERI system equipment on the construction site, for any necessary assembly work and during initial operations. As a result, use of the PERI formwork and scaffolding technology is safe and efficient right from the very beginning.



### PERI Engineering means

#### Optimized solutions

Project-specific customized planning

#### A personal contact Partner

Continuous project support and technical advice from a PERI specialist – if required, also directly on the jobsite

#### Application safety and reliability

Through detailed drawings and, if required, auditable static calculations



PERI sales engineers and supervisors provide active on-site assistance in order to ensure the most efficient execution.

From the Instructions for Assembly and Use along with Instructions for Use through to auditable, static calculations – we provide the respective technical documentation required for every project.

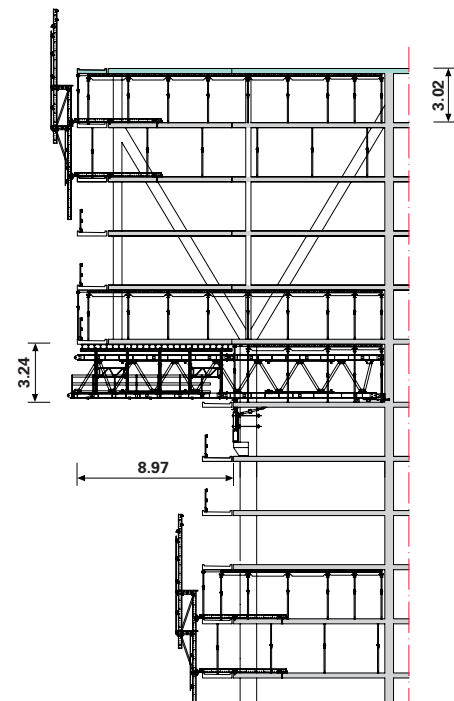

**De Rotterdam, Rotterdam, Netherlands**  
 Complete enclosure with the RCS P Climbing Protection Panel provided maximum protection and facilitated a safe and fast working environment in the two topmost floors under construction. An important element of the PERI solution was the VARIOKIT truss construction for supporting the up to 9 m cantilevered floors at the halfway point of the building.



# RCS Climbing Formwork

## RCS C with Carriage for standard applications

**The RCS C Rail Climbing Formwork is the system for standard applications with 2.70 m to 4.50 m high wall formwork.**

The climbing procedure with RCS C is fast and safe at all times because the moving unit is always connected to the building by means of climbing rails. The 125 mm hole pattern of the climbing rails allows optimum adaptation of the platforms to suit the floor height. The climbing units can be quickly and safely moved with the crane through the continuous climbing rail. As an option, the mobile self-climbing hydraulics provide crane-independent climbing to the next floor.

The formwork is securely installed on a smooth running, roller-mounted carriage which can be retracted by up to 90 cm.

### The formwork

Both the VARIO GT 24 Girder Wall Formwork as well as panel formwork such as TRIO can be adjusted in all directions when mounted on the strongback.

### The working platforms

The position of the working platforms is adjusted to suit the floor height. This results in safe and fast access possibilities to the platforms through openings in the building.

### The guardrails

Handrail boards or scaffold tubes provide the required level of safety when working on the platforms. 2.00 m high guardrails on the main working platform guarantee an enhanced level of safety. Alternatively, a complete enclosure is possible.

RCS C with Carriage for rail-guided climbing of wall formwork – self-climbed is available as an option.

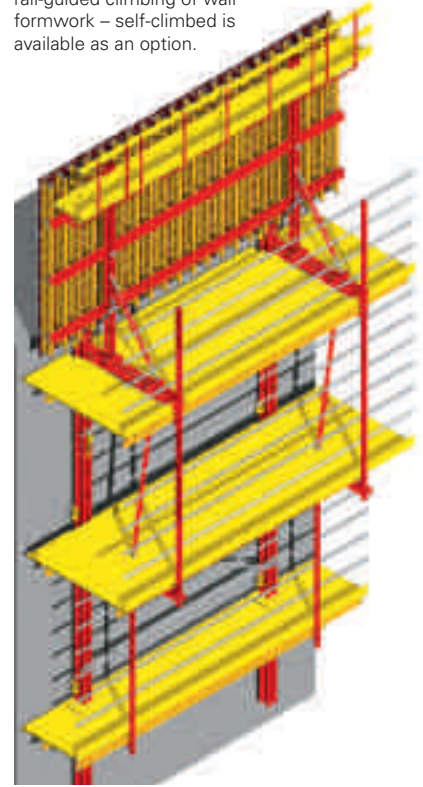

### The climbing procedure

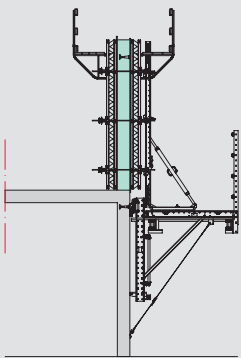

Use of climbing formwork on the first casting segment.

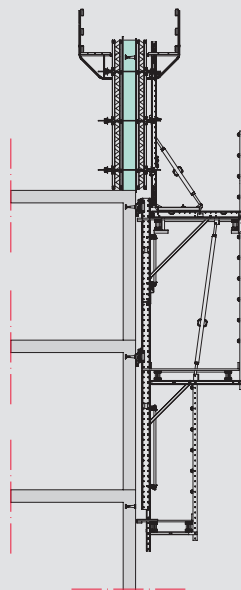

Concreting of the standard cycle with the complete system.

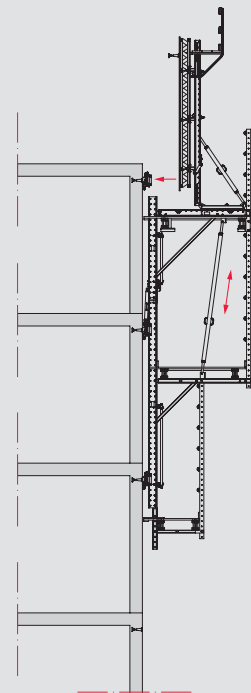

Rail-guided climbing with the crane or mobile climbing hydraulics.

**The structural system**

The RCS structural system consists of two bracket units arranged on top of each other which are connected with each other by a hinge in the climbing rail and a spindle. When extending the spindles, the movable construction tilts inwards thus allowing wall recesses to be climbed over.

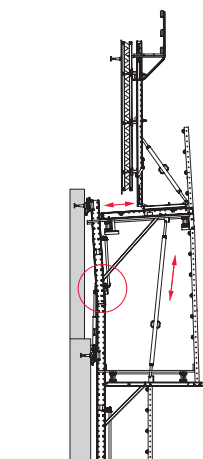

**The RCS Carriage**

The formwork is connected to the carriage by means of SRU Strongbacks and SLS Spindles. Due to the front roller bearings, it can be easily and smoothly retracted up to 90 cm. The self-locking capability of the gear safely fixes the carriage in every position without requiring any additional tools. The SLS Spindle is used for adjusting the formwork inclination whereby the height is adjusted using the height adjustment unit.



**The anchoring**

Standard anchoring of the RCS Climbing Scaffold is carried out with the Wall Shoe and RCS Climbing Shoe. The components are very light and can be quickly mounted. PERI Climbing Anchors have a building authority approval, so the high load-bearing capacity and quality are certified.



The RCS Climbing Formwork with continuous high side protection provides safe working areas at great heights.

# RCS Climbing Formwork

## The lightweight RCS CL Self-Climbing Formwork for medium-height buildings with limited crane availability

The lightweight RCS CL Self-Climbing Formwork is ideally suited for external facades as well as cores of medium-height structures formed in advance. Also on construction sites with limited crane availability, this variant of crane-free climbing provides enormous advantages.

The RCS CL differs in that only one finishing platform is used. For this variant, climbing rail extensions and intermediate climbing shoes are utilized.

### The Climbing Rail Extension

After installation of the Climbing Rail Extension, the mobile climbing device is mounted from a position on the main platform. This allows the system to climb without a crane from the first section onwards.

### The Intermediate Climbing Shoe

The additional shoes, positioned at the halfway point of the section height, allow rail-guided climbing even with shorter climbing rails. Dismantling of the Intermediate Climbing Shoe is carried out from the finishing platform. Therefore the climbing procedure is briefly interrupted.

The variant with only one finishing platform saves assembly time and space requirements down below.

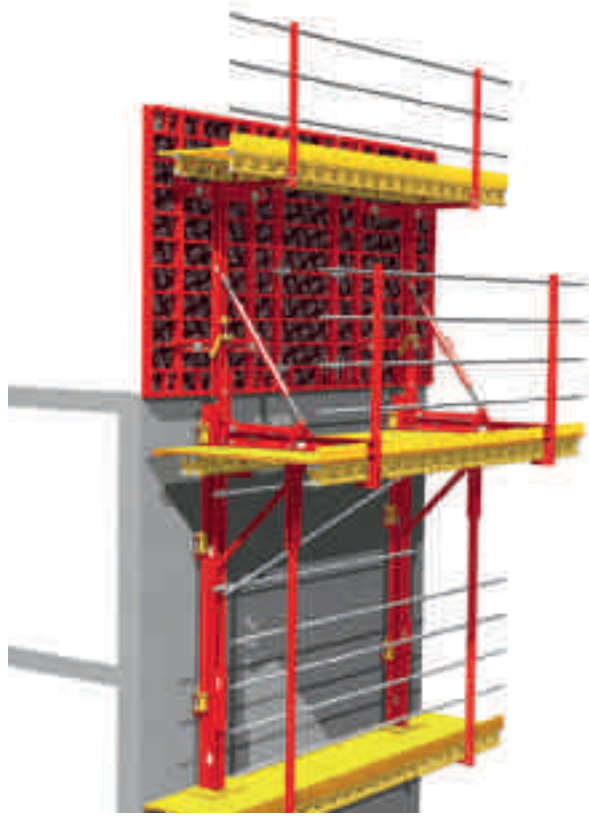

### The climbing procedure

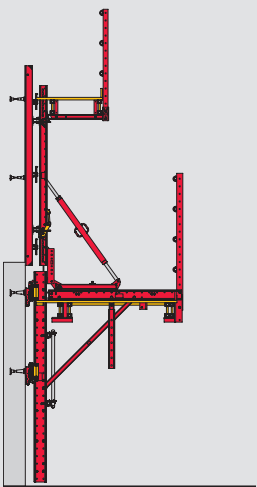

Use of the RCS CL on the first casting segment.

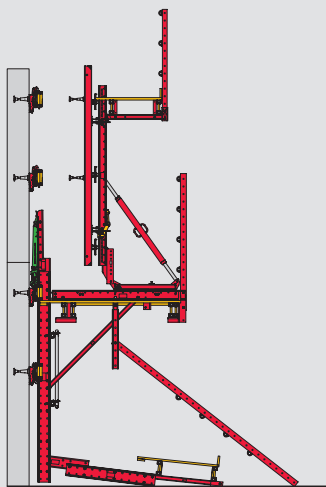

Mounting of the finishing platform and installation of the self-climbing hydraulics.

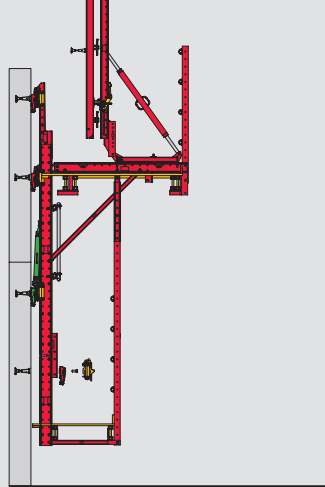

Dismantling the Intermediate Climbing Shoe from the finishing platform.

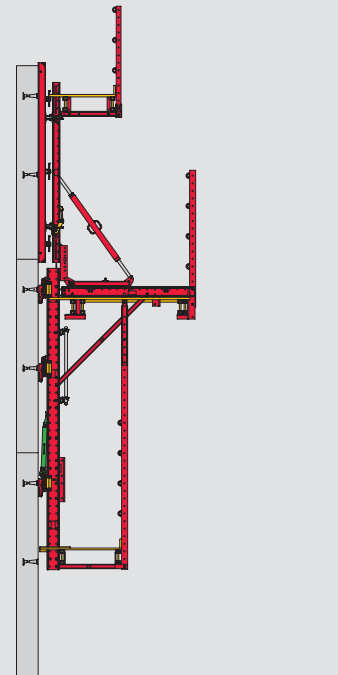

Concreting of the standard cycle with the RCS CL Self-Climbing Formwork.



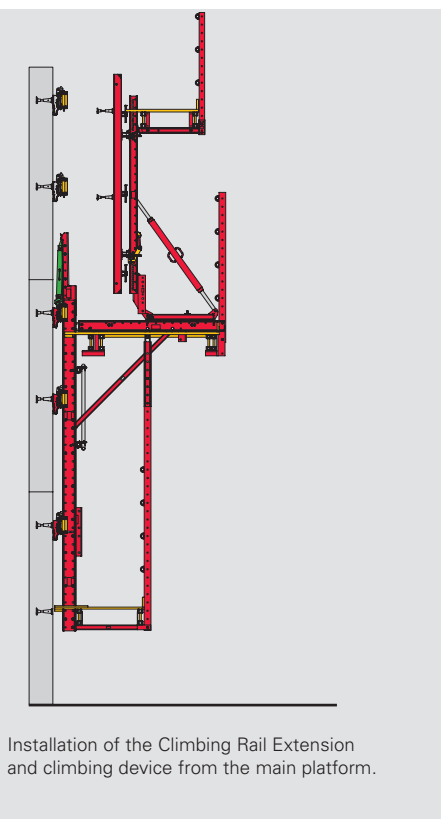

Installation of the Climbing Rail Extension and climbing device from the main platform.



The use of the lightweight rail-guided climbing formwork for a circular structure with the VARIO GT 24 Girder Wall Formwork.

The RCS CL climbs steadily upwards on these building cores without a crane – in part even without finishing platform. Dismantling of the Intermediate Climbing Shoes is carried out from a safe position on the following slab.

# RCS Climbing Formwork

## The non-guided, crane-climbed RCS CB version

**Especially for construction sites with sufficient crane capacity or if rail-guided climbing is not feasible, the non-guided, crane-climbed RCS CB version is a useful solution.**

Areas of application for the RCS CB are medium-height buildings with a limited number of storeys. An advantage of the non-guided version is that laterally off-set climbing is likewise possible as in those situations when climbing over obstacles.

If required, the traditional climbing procedure can be converted into self-climbing, rail-guided climbing units using the same components. This saves costs regarding material requirements and transport, and leads to greater efficiency through mixed application.

Platform and formwork are moved together as one unit. The formwork is connected to the smooth-running carriage – complete with roller bearings – by means of SRU Strongbacks and SLS Spindles.

### **Bridging larger openings**

The pressure point of the bracket is adjustable in 125 mm increments, and can also bridge large openings in the structure thanks to the RCS Climbing Rail. The Tension Belt 25 kN serves as wind bracing.



### **The RCS Lifting Beam**

The Lifting Beam 10 t is a lifting accessory for moving heavy RCS Climbing Units with the crane. The length of the Lifting Beam can be adjusted to suit the respective bracket spacing in 125 mm increments. A compression brace between the strongbacks is therefore not required as no diagonal pull occurs.

For symmetrical loads, the maximum load-bearing capacity is 10 t. With asymmetrical units, each lifting chain carries a maximum of 5 t. In this case, the one-sided chain shortener is to be used in order to position the crane hook above the centre of gravity. In this way, the load is horizontally aligned.

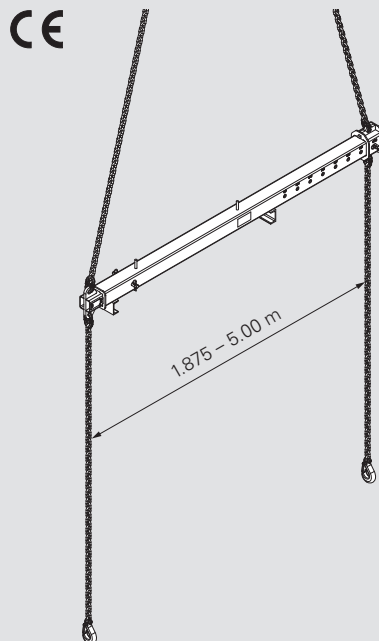

### **The suspension**

The Mounting Ring Adapter M30 with safety pins provides the connection to the climbing anchor with the scaffold mounting ring. This simple suspension allows very large units due to the high load-bearing capacity.







#### **Avala TV Tower, Belgrade, Serbia**

A gigantic tripod forms the base of the 200-metre high TV tower. The base supports with changing cross-sections were formed using VARIO GT 24, raised formwork units comprised of VARIOKIT elements supported the forward and reversed-inclined formwork panels. Diagonally arranged climbing RCS CB Climbing Formwork could subsequently be converted to RCS C Self-Climbing Units for the vertical upper part of the tower.



# RCS Climbing Formwork

## Reference projects



RCS provides safe working areas at the highest level – here completely enclosed.



As an alternative to complete enclosure, scaffold tubes or handrail boards also provide safe lateral protection.



This column formwork in the facade area climbs crane-independently upwards with the RCS Self-Climbing Technology. At the same time, the enclosure provides protection against wind and weather.



With the RCS Rail Climbing System, different wall formwork systems are used as well as the proven TRIO panel formwork.



Safe working conditions with continuous lateral and rear protection on and under the RCS C Climbing Formwork.





Complicated layouts can also be cost-effectively climbed with the RCS C formwork scaffold thanks to the flexibility – rail-guided and crane-independently.



Another typical area of application for the RCS Rail Climbing System is bridge piers.



The RCS Rail Climbing System used as formwork scaffold for the building core and as a climbing protection panel on the facade.

# RCS P Climbing Protection Panel

## Fall protection, weather protection and advertising space all at the same time

The RCS Climbing Protection Panel completely encloses the top floors of the building shell which are under construction. The enclosure protects site personnel against falling and strong winds at great heights. A positive side effect is that the protection panel can be used as highly visible advertising billboards.

Anchoring to the building is carried out by means of Slab Shoes or Slab Stopend Shoes with Climbing Shoes which guide the climbing rails and panel up the building during the climbing procedure. This ensures a fast and safe climbing procedure in all weathers.

The Climbing Protection Panel can also be efficiently moved with mobile, weight-optimized climbing hydraulics. The cylinders and hydraulic pump are conveniently transported on the floor slab.



### Assembly versions

With 4 different assembly versions, the RCS P Climbing Protection Panel can be optimally adapted to suit the respective requirements.

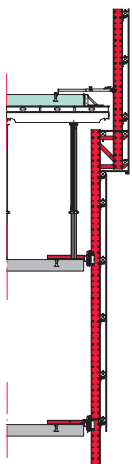

**Version 1**  
Standard assembly with narrow working platform.

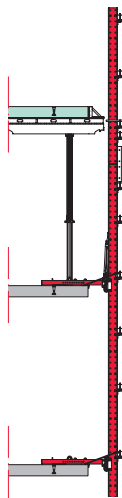

**Version 2**  
The simplest version with a continuous climbing rail in case no working platform is required.

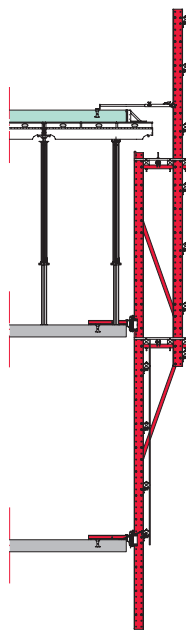

**Version 3**  
This version with 2 wide working platforms provides surrounding access and space for pre-tensioning the floor slab.

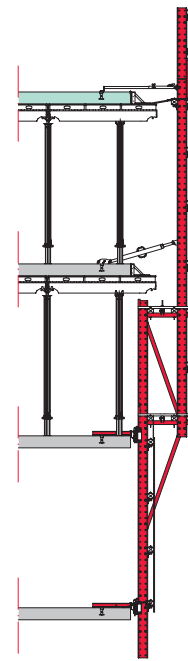

**Version 4**  
The version with 2 wide working platforms for enclosing the 2 topmost floors under construction accommodating double on-site formwork material quantities.



The completely shielded working area provides protection against the wind and weather. In addition, the enclosure creates a sense of safety that significantly increases the working productivity.



For special solutions with hydraulic folding units of the Climbing Protection Panel, large-sized slab tables can easily be moved.

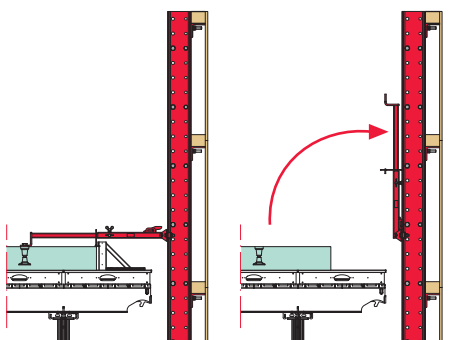

**Slab Anchor Template**

The Leading Anchor can be quickly and easily positioned with the foldable Slab Anchor Template. This saves time-consuming measuring procedures. After concreting, the template is simply folded up whereby it automatically locks in a vertical position.



**Complete all-round safety**

Flaps with overlying rubber mats ensure that the gaps between the enclosure and slab are completely covered. During the climbing process, the flaps can be fixed to the Climbing Protection Panel.



**Adapter VT 20/RCS P**

With the Adapter, VT 20 Formwork Girders can be used as a supporting Climbing Protection Panel. These are available from the rental parks which in turn increases the cost-effectiveness of the climbing solution.



# RCS P Climbing Protection Panel

## Enclosure variants for all requirements



**PERI offers a number of enclosure versions. This facilitates optimal protection for all construction site requirements and for any climate.**

The enclosure is selected according to the project and region. In cold weather conditions, for example, enclosed storeys with wooden multilayer panels or corrugated steel sheets can be heated. Permeable structures such as perforated steel sheets or LPS Mesh Panels, however, have the advantage that they prevent heat accumulation inside buildings in warmer climate zones. In addition, they provide sufficient light inside in the building.

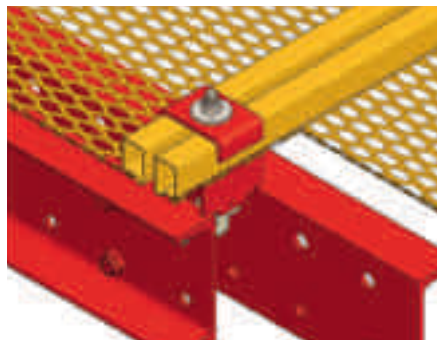

The lightweight LPS Mesh panels are easily and quickly mounted to the climbing rail by means of clamp connectors.



Here, the Climbing Protection Panel not only serves as all-round anti-fall protection for the top 3 floors under construction but also as highly visible advertising space.



**LPS Mesh Panel**

Working safety is guaranteed thanks to the close-meshed expanded metal grating in spite of the strongly reduced wind exposure area.

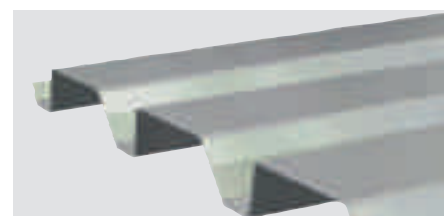

**Closed corrugated steel sheets**

An alternative to the wooden multilayer panels for colder and moderate climate zones, in particular for multiple usage.

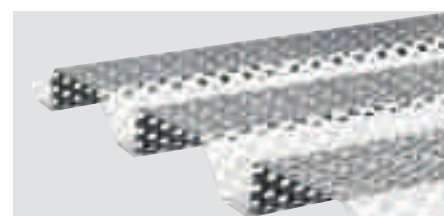

**Perforated corrugated steel sheets**

In warmer regions, the perforation prevents heat accumulation in the building whereby working safety is unaffected.

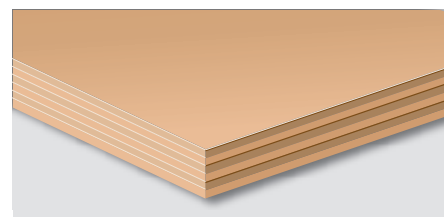

**Wooden multilayer panels**

The inexpensive version for colder regions if the floor is to be heated. In addition, the outer surface is ideally used for advertising purposes.



# RCS P Climbing Protection Panel

## Reference projects



In Australia, mesh enclosures are frequently used due to the high temperatures. This allows not only air but also light to enter the building.



The repeatedly recessed facade construction characterizes the DC Tower in Vienna. The Climbing Protection Panel could be continually adjusted to match the variable floor areas.



This gap-free mesh enclosure in Japan ensured a high level of safety while simultaneously providing light and air permeability.



The RCS Climbing Protection Panel in use for the construction of the Asia Square Tower in Singapore. The integrated landing platforms ensure easy transport of materials from floor to floor.





The RCS Climbing Protection Panel secures the leading edges of the subsequently realized floor slabs in the Vodafone Office Tower in Düsseldorf. The core of the elliptically-shaped structure rose steadily in height with the help of RCS and ACS Self-Climbing Technology.



# RCS MP Landing Platform

## The flexible solution for moving loads by crane

**The RCS MP Landing Platform serves to move formwork and materials on high-rise buildings. The platform can either be anchored in the slab or clamped between two floor slabs by means of MULTIPROP props.**

The RCS MP Steel solution includes anti-slip checkered steel sheeting and all-round side protection on the platform using LPS Mesh Panels. This guarantees a very high level of working safety. The additional scaffold tubes positioned above also provide safe working conditions when attaching formwork tables.

As standard, the RCS MP Steel Landing Platform is available as a preassembled unit with lengths of 3.75 m and 5.50 m, with a minimum clear width of 2.52 m. Integrated attachment points simplify the moving procedure.

The high load-bearing capacity and flexible mounting options make the RCS MP an ideal piece of work equipment on any construction site – for moving building materials from one floor to any other floor in the building.

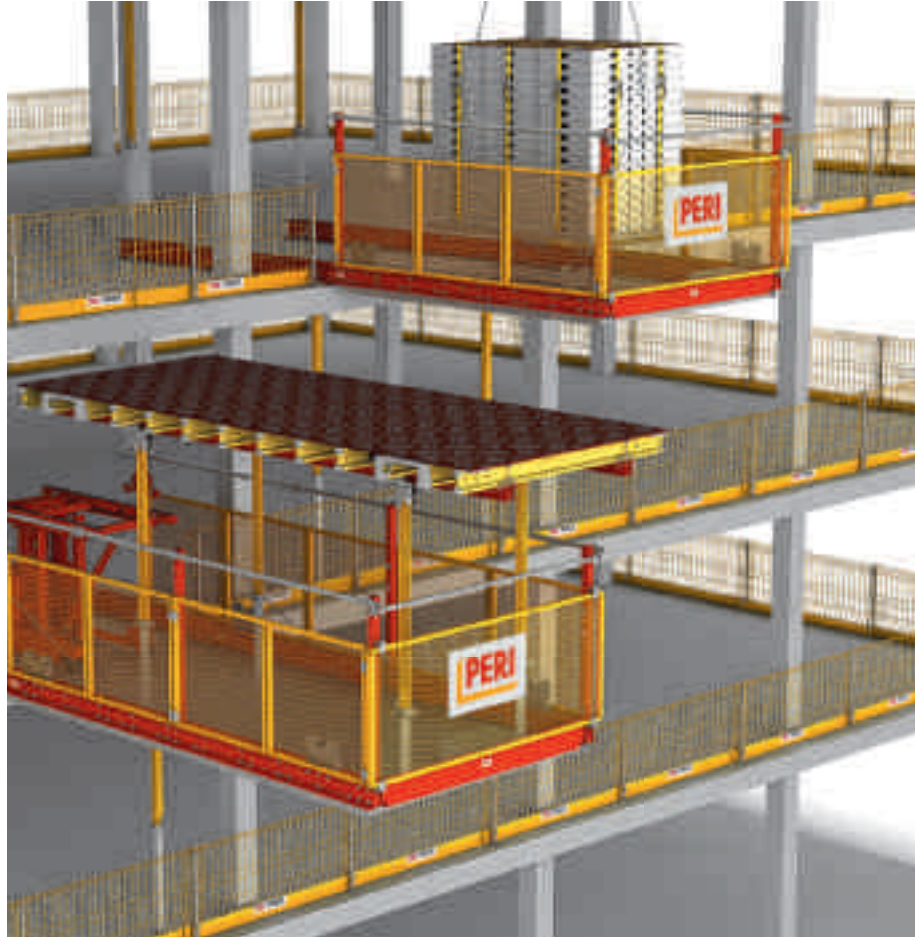

The RCS MP Steel Landing Platform is the flexible solution for moving loads by crane.



The platforms are 3.00 m wide. They can be stacked pre-assembled and space-savingsly transported. The guardrails are simply inserted on the construction site and secured by means of bolts.





**Special platforms with GT 24 Formwork Girders**

Alternatively, platforms for the Landing Platform can be realized with GT 24 Formwork Girders and RCS Climbing Rails. Such special platforms are planned and mounted according to site-specific requirements.

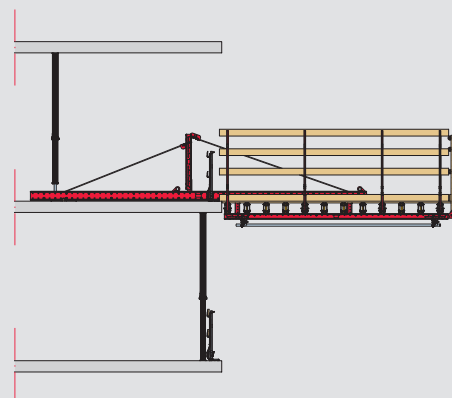

With additional loads, RCS Climbing Rails serve as load-bearing profiles of the RCS Landing Platform depending on the cantilever and load.

**Variable positioning**

The platform can be freely positioned at any place on the building whereby different mounting options are available:

1. Anchoring of the RCS carrier profiles in the slab with climbing anchors or tied through the concrete by means of DW 15 Tie Rods.
2. Clamping of the carrier profiles between the floor slabs with MULTIPROP Slab Props – without any mounting parts or drilling into the slabs.

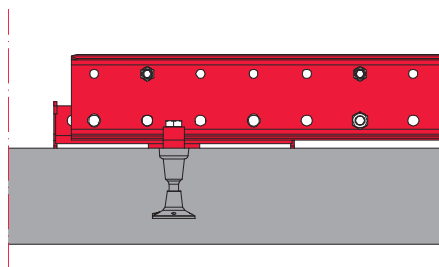

**Anchoring in the slab**

Through the use of the RCS M24 Slab Support Anchor Shoe and the certified M24 Climbing Anchor, the platform can be anchored in the slabs of the building.

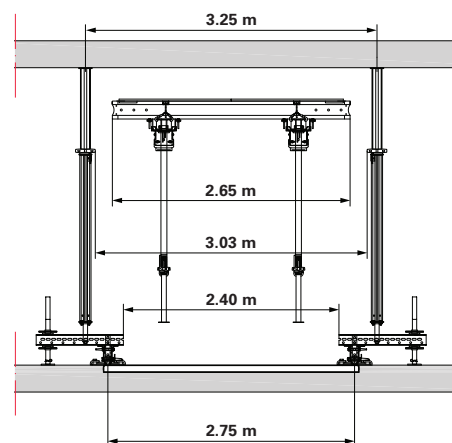

**Clamping between the slabs**

If MULTIPROP props are positioned on additional SRU Walers, the passage opening is over 3.00 m wide and therefore also suitable for large-sized tables.

# RCS ML Material Lifter

## The complete solution for moving slab tables without a crane

**The two-piece material lifter consists of a self-climbing landing platform and a lifting bracket with integrated Hoisting Trolley. As a result, slab tables can be moved up to 3 storeys (max. 20 m) without any crane assistance.**

The rail-guided climbing of 2 transportable units is carried out with the help of RCS Self-Climbing Devices. As the Landing Platform and Lifting Unit are separated from each other, the weight to be moved during assembly and when climbing is only 3.5 t. For the transportation of slab tables or pallets with panel slab formwork, a Hoisting Trolley is used with a 1.6 t lifting capacity.

An additional safety feature: the Hoisting Trolley raises the load over the assembled guardrails on the top floor slab; time-consuming opening and closing of loading gates is not required.

### Climbing procedure

When using the RCS Climbing Hydraulics, the Lifting Bracket is climbed to the next storey first; materials can now be lifted through a height of 2 floors up to the topmost floor slab. Following this, the Landing Platform is also climbed one floor.



### Lifting Bracket and Landing Platform

The topmost set of guardrails remains in position – the load is simply lifted over them.

### Lifting procedure

Simple moving procedure with the PERI RCS ML Material Lifter in only 4 steps over 2 storeys:

1. Move the table form onto the landing platform using the Table Trolley and attach with slings
2. Hoist the table form by means of the chain hoist
3. Move the table form over the mounted guardrails into the building by means of the Hoisting Trolley
4. Lower the table form onto the top Table Trolley

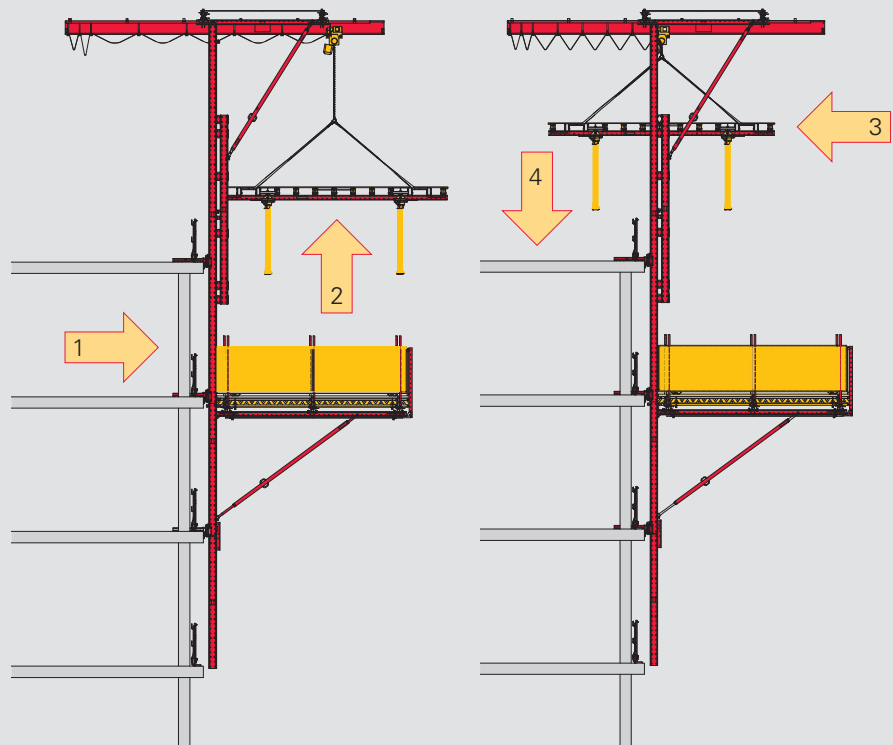



**The self-climbing Landing Platform can also be used without Lifting Brackets. It is rail-climbed using RCS Self-Climbing Technology – no crane is required thereby saving a significant amount of time.**

As standard, Slab Shoes and RCS Climbing Shoes are used for mounting to the slab while anchoring is carried out with the M24 Anchoring System. One big advantage: the platform along with the supporting structure is mounted on the outermost edge of the slab. As a result, there are no load-bearing profiles or slab props causing obstructions inside the building. Working areas are therefore free of any restrictions. With the RCS Wall Shoe, anchoring is also possible in perforated facades or columns.

The Landing Platform is delivered already pre-assembled, and it can be transported as a foldable unit on a truck. The dimensions can be easily adapted to suit the respective jobsite requirements.

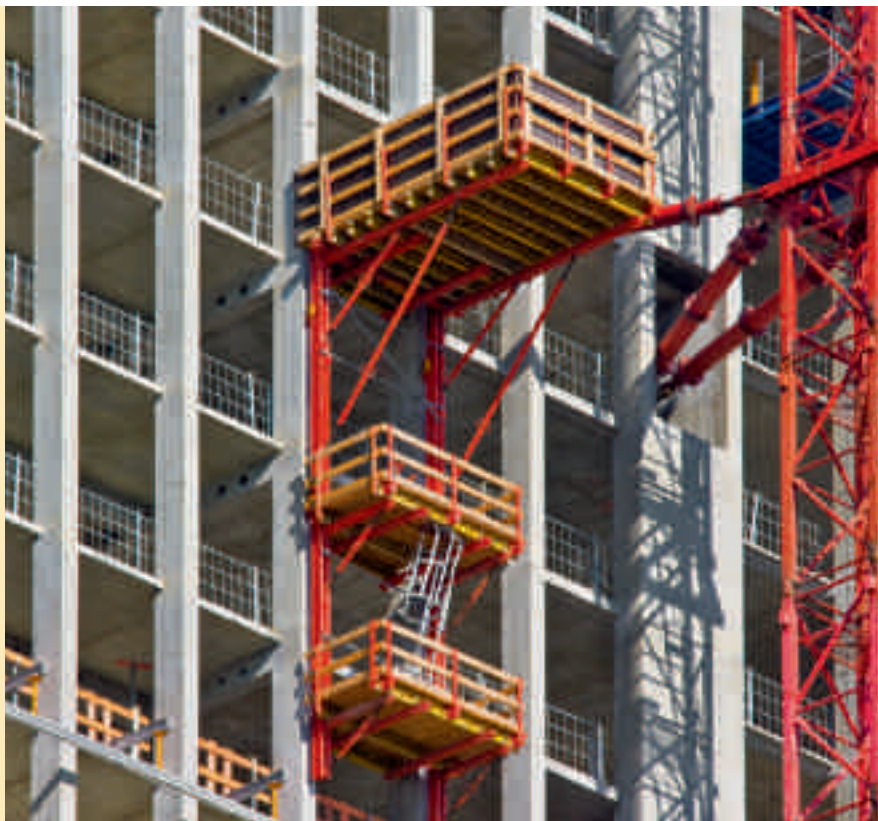

This self-climbing RCS Bracket Platform with 2 finishing platforms on a high-rise building is anchored in the facade columns by means of the RCS Wall Shoe.

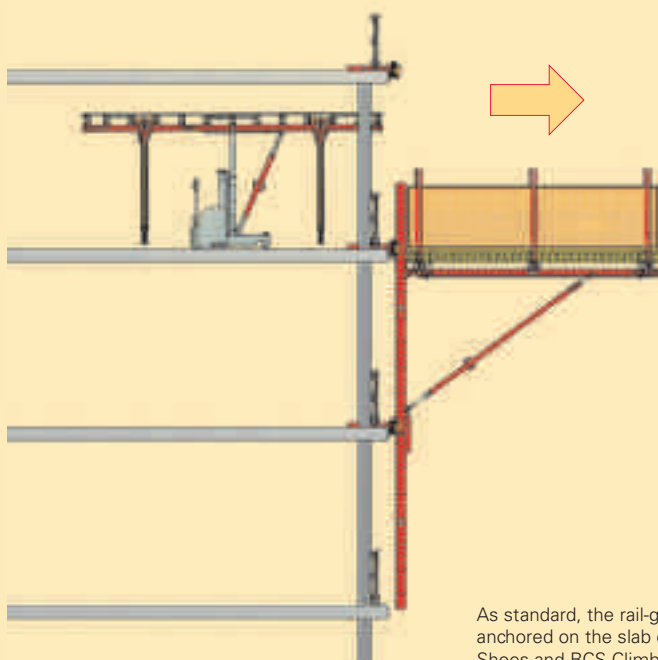

As standard, the rail-guided Landing Platform is anchored on the slab edge. For this, RCS Slab Shoes and RCS Climbing Shoes are used.

# Special solutions with the RCS Rail Climbing System

## Wide range of possibilities thanks to the construction kit logic

The system components of the RCS Construction Kit can be used extremely flexibly for special applications – especially in combination with components taken from the ACS Self-Climbing System and the VARIOKIT Engineering Construction Kit.

RCS Climbing Rails with the regular 125 mm hole pattern offer a high level of flexibility and numerous combination possibilities with components of other PERI systems. This results in a wide range of constructions for project-specific requirements with a very small number of special components.

As PERI stores all system components in its rental parks such special applications can be implemented extremely cost-effectively and without high investment costs. In addition, the high proportion of rentable system components guarantees fast material availability.



For the pylon of a bridge in Nigeria, PERI combined the ACS and RCS systems. Crane-independent working ensures rapid construction progress in spite of the continuously changing pylon inclinations.

Integrated access solutions with PERI UP: a climbing stair tower provides safe access to the finishing platform of the self-climbing system or to the topmost storey slabs under construction; it is positioned on a cantilevered platform.





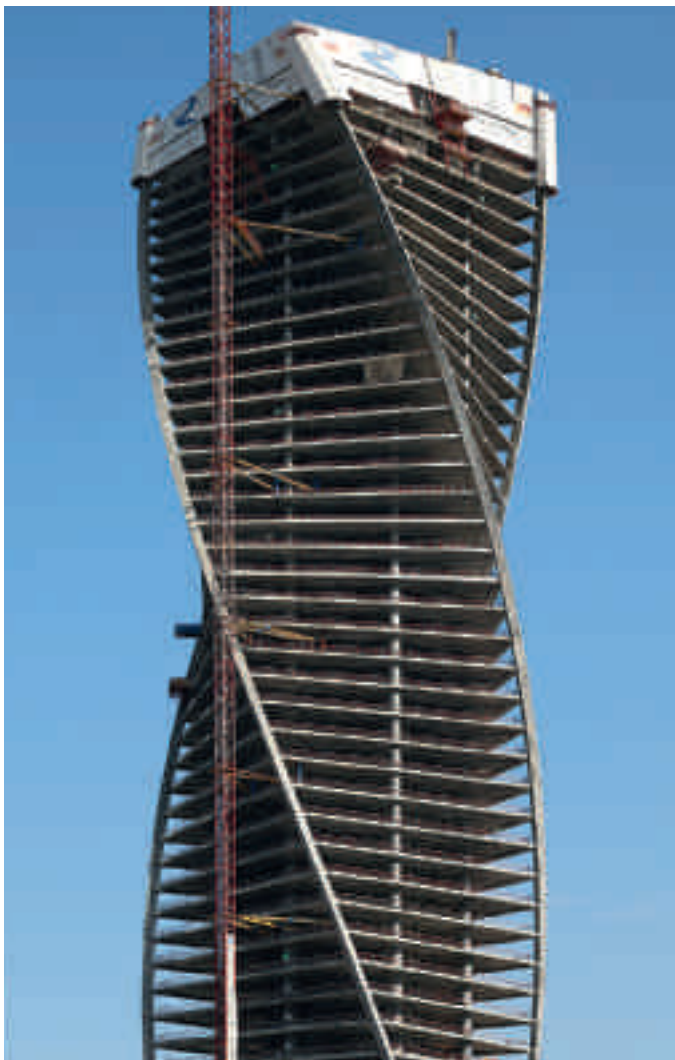

With a 150° rotation, the Evolution Tower twists its way upwards into the Moscow sky reaching a height of almost 250 m. Inclined and crane-independent climbing RCS Protection Panel Units provide a very high level of safety.



Landing Platforms can also be rail-climbed by means of the mobile RCS Climbing Hydraulics – this additionally minimizes crane usage.



Here, the climbing rails of RCS Protection Panel follow the inclined form of the structure. Special slab shoes guarantee secure connection of the rails to the structure.



Trusses comprised of rentable RCS and VARIOKIT System Components not only carry the fresh concrete loads of the balconies but also the protection panel construction for the upper floors.

# RCS Anchoring

## Flexible mounting solutions for the RCS Rail Climbing System

**Flexibly usable anchors ensure that the climbing rails are securely mounted on the structure – suitable for any building geometry.**

The climbing shoe guides as well as provides support for the RCS Climbing Rail. It securely connects the Climbing Formwork Unit or Climbing Protection Panel to the building during the entire climbing procedure. As a result, it is not possible for the RCS Climbing Unit to “drift” during strong winds thus making the climbing procedure extremely safe. The integrated climbing pawl automatically engages the bolts of the climbing rail and secures the unit at 50 cm spacings.

For anchoring the climbing shoe to the wall or slab, the PERI product portfolio features a wide range of wall and slab shoes. With alternating projecting and recessed slab edges, cantilevered RCS Rails with corresponding Adapter provide the most suitable solution.

### Anchoring in the wall

Standard anchoring of the RCS Climbing Formwork is carried out with the RCS Wall Shoe and RCS Climbing Shoe. The Climbing Shoe provides the necessary flexibility in order to attach the Climbing Rail with up to  $\pm 4^\circ$  inclinations. Thus, the formwork can also climb over wall offsets. Due to the foldable skids, the climbing unit can be easily mounted; a complicated threading procedure is not necessary.

For anchoring on circular walls, a rotatable Wall Shoe is available with a pivoting range of  $\pm 15^\circ$ .

The M30 Anchor System is used for both wall shoes.

#### Top view:

##### RCS Wall Shoe and RCS Climbing Shoe

Due to the foldable skids, the climbing shoe can be laterally dismantled. In addition, this simplifies the initial assembly.



#### Section:

##### RCS Wall Shoe and RCS Climbing Shoe

The articulated connection allows vertical inclinations of the climbing rail of up to  $4^\circ$ . For 3.00 m floor heights, wall offsets of up to 20 cm, for example, can be climbed over.

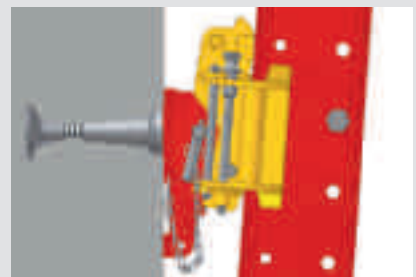
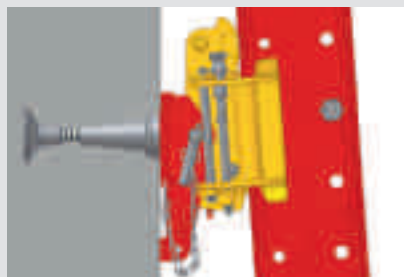

#### Top view:

##### RCS Wall Shoe, pivoted and RCS Climbing Shoe

The right solution for circular structures which feature a pivoting range of  $\pm 15^\circ$ . This ensures that the brackets are arranged parallel to each other, and the carriage together with the formwork can be retracted.





**Anchoring in the slab**

The RCS P Climbing Protection Panel is normally anchored with the RCS Slab Shoe and RCS Climbing Shoe on the floor slab. The Climbing Rail is thereby arranged with a 15 cm clearance to the slab edge. The RCS Slab Shoe Adjustable 30 allows cantilevers from 15 cm to 45 cm. Both slab shoes are anchored with M24 Climbing Anchors.

The Stopend Slab Shoe is used on the corners of a building or in the area of offset columns. A Stopend Slab Anchor serves as anchorage which is fixed in advance to the Stopend Formwork.

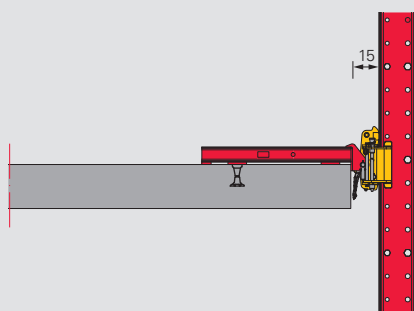

**RCS Slab Shoe**

Standard anchoring of the Climbing Protection Panel: the Climbing Shoe is mounted on the slab edge with the RCS Slab Shoe. On building corners, an RCS Slab Shoe Corner is used transversely.

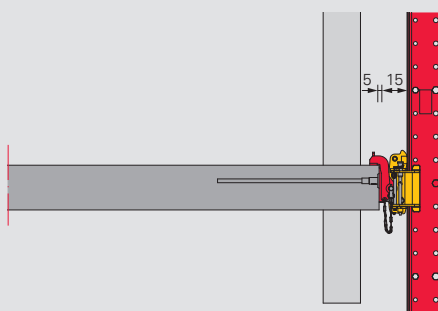

**RCS Stopend Slab Shoe**

The Stopend Slab Shoe is used for mounting the Climbing Shoe on the front end of a slab while the anchoring is carried out by means of a Stopend Slab Anchor.

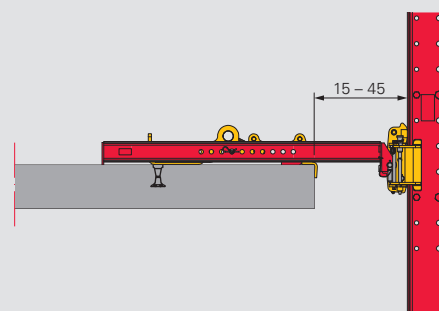

**RCS Slab Shoe Adjustable 30**

The RCS Slab Shoe Adjustable 30 provides a 30 cm adjustment range. It can be used for projections of up to approx. 45 cm.

**RCS Slab Support**

For very large cantilevers, in the order of 2.0 m, the slab support components (Anchor Shoe, Adjusting Shoe, Adapter) are connected with a horizontal RCS Climbing Rail. Thus, for buildings with alternating projecting or recessed slab edges, the RCS Climbing Protection Panel can also be guided up the structure in a line.

- 1 Slab Support Adapter RCS
- 2 Climbing Rail RCS
- 3 Climbing Shoe RCS
- 4 Slab Support Anchor Shoe RCS M24
- 5 Slab Support Alignment RCS

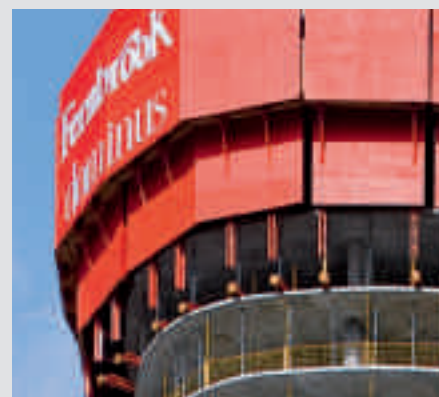
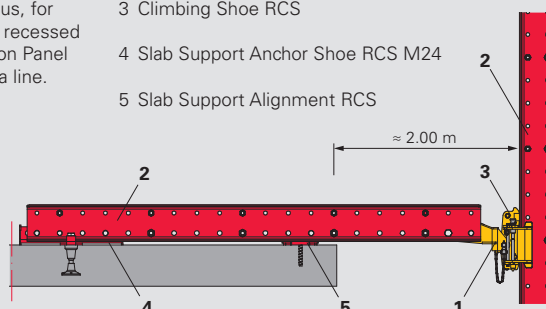

# RCS Self-Climbing Hydraulics

## Cost-effective climbing without use of a crane with mobile RCS Climbing Devices

The weight-optimized components of the mobile climbing hydraulics are easy to transport and extremely simple to handle.

**The RCS C and RCS CL Rail Climbing Formwork along with the RCS P Climbing Protection Panel and the RCS ML Material Lifter can also be hydraulically climbed without a crane.**

The use of mobile self-climbing devices and hydraulic pumps is also cost-effective for structures with lower heights as only one hydraulic kit is required for climbing all the units. As an option, the mobile self-climbing equipment can also be retrofitted at any time.

### Flexible climbing with RCS

With the RCS Rail Climbing System, the Climbing Rail is not climbed in advance but is an integral part of the system. The RCS 50 Climbing Device raises the climbing unit in 50 cm increments. Two climbing units are climbed the height of one storey with one hydraulic kit in each case. In the process, the Climbing Device is positioned on the Climbing Shoe and is moved to the next climbing units after the climbing procedure is completed.

### Functionality details

The Climbing Device works together with the self-operating bearing pawl in the Climbing Shoe. The claw on the upper end of the piston of the hydraulic cylinder engages the climbing bolts of the Climbing Rail and pushes this with the formwork scaffolding or protection panel 50 cm upwards. At the end of the stroke, the bearing pawl of the Climbing Shoe engages the climbing bolts which are arranged below. It accepts the load while the cylinder retracts thereby avoiding the next climbing bolts, and then engages this.



The hydraulic cylinder with its 5 t lifting capacity is positioned on the climbing shoe.



The climbing units are raised with a lifting speed of 1 m/min.



**Anchoring**

Independent of the type of anchoring, the RCS Climbing Device reliably operates in connection with the pawl in the climbing shoe.

**RCS C Climbing Formwork**

Anchoring in the wall

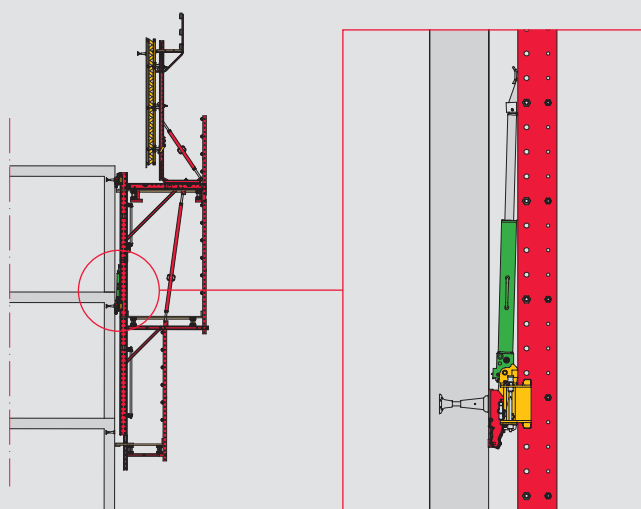

**RCS P Climbing Protection Panel**

Anchoring in the slab

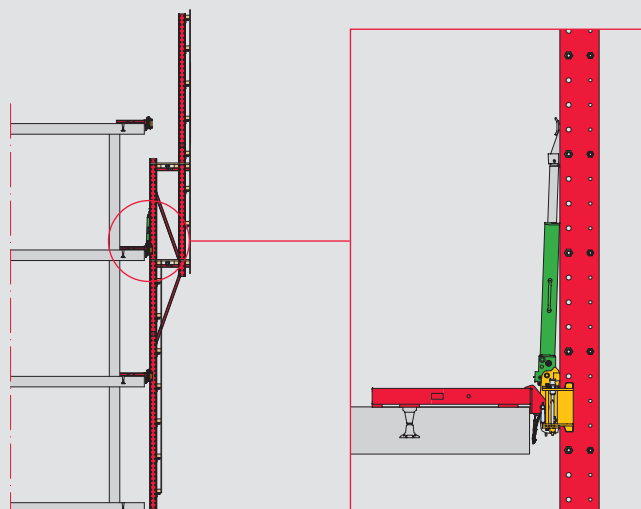

On the RCS Hydraulic Pump, up to four RCS 50 Climbing Devices with hydraulic double hoses can be connected. The integrated flow divider ensures synchronous climbing thus preventing a collision of the climbing units.



The quick couplings of the double hoses are connected within seconds to the hydraulic cylinder and pump. The clearly arranged socket and nipple avoids any incorrect connections as well as allowing easy installation.

Item no.	Weight kg		L
114166	78.200	<b>Climbing Rails RCS</b>	1480
109469	130.000	<b>Climbing Rail RCS 148</b>	2480
112102	156.000	<b>Climbing Rail RCS 248</b>	2980
109470	182.000	<b>Climbing Rail RCS 298</b>	3480
112141	209.000	<b>Climbing Rail RCS 348</b>	3980
109471	262.000	<b>Climbing Rail RCS 398</b>	4980
109472	393.000	<b>Climbing Rail RCS 498</b>	7480
109610	524.000	<b>Climbing Rail RCS 998</b>	9980

Steel profile for all-purpose use of climbing application or civil constructions. With Spacers M20-82 and M24-82.

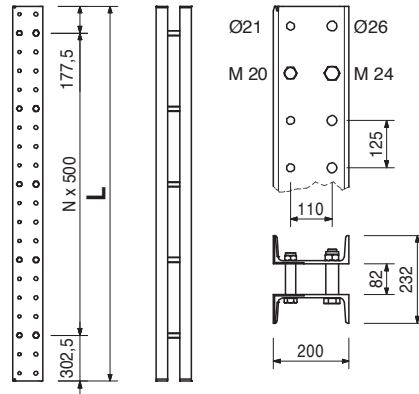

110022	0.493	<b>Spacer M20-82</b> Spacer for Climbing Rails RCS.	<b>Complete with</b> 1 pc. 104477 Bolt ISO 4014 M20 x 120-8.8, galv. 1 pc. 781053 Nut ISO 7042 M20-8, galv.
--------	-------	--	---

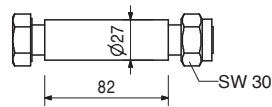
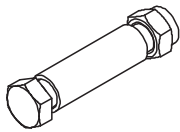

110023	0.910	<b>Spacer M24-82</b> Spacer for Climbing Rails RCS.	<b>Complete with</b> 1 pc. 109612 Bolt ISO 4014 M24 x 130-8.8, galv. 1 pc. 105032 Nut ISO 7042 M24-8, galv.
--------	-------	--	---

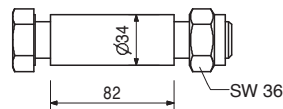
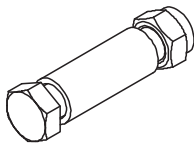

115626	1.880	<b>M24 Kicker Connector RCS</b> Bolted in holes Ø 26 of the Climbing Rail RCS. Serves for connecting Kicker AV or Bracing DW 15.	<b>Complete with</b> 1 pc. 115916 Pin Ø = 16, L = 70 mm, geomet. 2 pc. 018060 Cotter Pin 4/1, galv. 1 pc. 109612 Bolt ISO 4014 M24 x 130-8.8, galv.
--------	-------	---	--

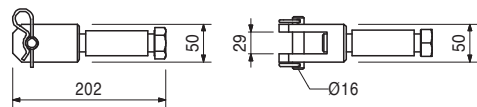
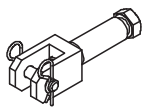



Item no.	Weight kg
110569	16.700

### Climbing Rail Hinge RCS

For an articulated connection of the Climbing Rails RCS and as pressure point on the RCS Climbing Brackets.

### Complete with

3 pc. 710894 Pin  $\varnothing$  25 x 180, geomet.  
4 pc. 018060 Cotter Pin 4/1, galv.

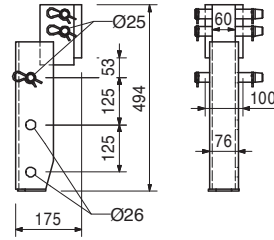
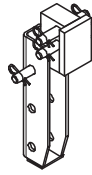

109791	25.900
--------	--------

### Climbing Rail Extension RCS 100

As extension of the Climbing Rail RCS for connecting the finishing platform.

### Complete with

2 pc. 109612 Bolt ISO 4014 M24 x 130-8.8, galv.  
2 pc. 105032 Nut ISO 7042 M24-8, galv.

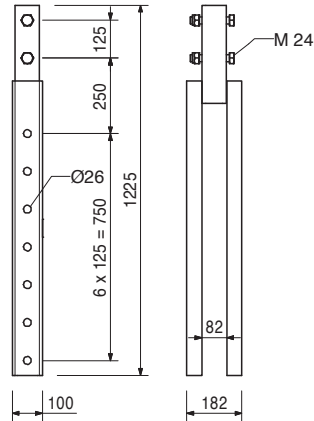

111390	32.800
--------	--------

### Climbing Rail Connector RCS 97

For rigidly connecting the Climbing Rails RCS. With connection for the Heavy-Duty Spindles SLS.

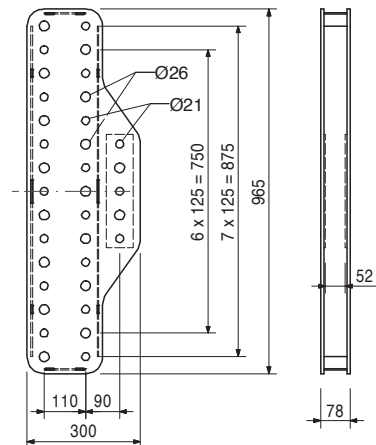
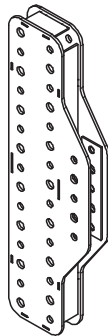

### Accessories

104031	0.462	<b>Fitting Pin <math>\varnothing</math> 21 x 120</b>
018060	0.030	<b>Cotter Pin 4/1, galv.</b>
111567	0.729	<b>Fitting Pin <math>\varnothing</math> 26 x 120</b>
022230	0.033	<b>Cotter Pin 5/1, galv.</b>

Item no.	Weight kg
113744	21.000

## Climbing Rail Connector RCS 73

For rigid connection of Climbing Rails RCS. Perm. bending moment limited.

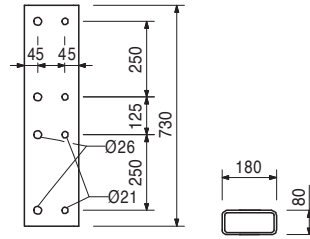

### Accessories

104031	0.462	<b>Fitting Pin Ø 21 x 120</b>
018060	0.030	<b>Cotter Pin 4/1, galv.</b>
111567	0.729	<b>Fitting Pin Ø 26 x 120</b>
022230	0.033	<b>Cotter Pin 5/1, galv.</b>

111833	12.700
--------	--------

## Climbing Rail Connector RCS 40

For an articulated connection or doubling of the RCS Climbing Rails.

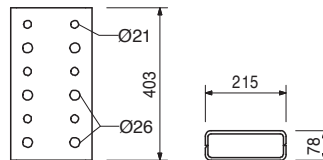
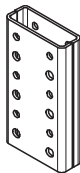

### Accessories

104031	0.462	<b>Fitting Pin Ø 21 x 120</b>
018060	0.030	<b>Cotter Pin 4/1, galv.</b>
111567	0.729	<b>Fitting Pin Ø 26 x 120</b>
022230	0.033	<b>Cotter Pin 5/1, galv.</b>

109743	6.370
--------	-------

## Climbing Rail Connector RCS 33

For an articulated connection of RCS Climbing Rails.



### Complete with

3 pc. 710894 Pin Ø 25 x 180, geomet.  
6 pc. 018060 Cotter Pin 4/1, galv.

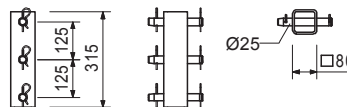



# RCS Rail Climbing System

Item no.	Weight kg
111283	9.950

## Angle Connector RCS/SRU

For right-angled connection of Steel Walers SRU to the Climbing Rails RCS and for attaching guardrail posts to Steel Walers SRU.

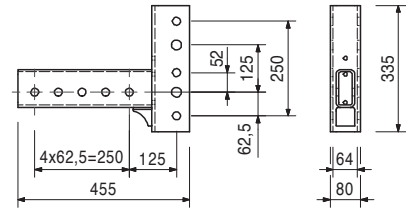
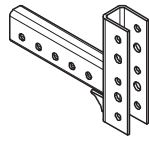

### Accessories

104031	0.462	<b>Fitting Pin Ø 21 x 120</b>
018060	0.030	<b>Cotter Pin 4/1, galv.</b>
111567	0.729	<b>Fitting Pin Ø 26 x 120</b>
022230	0.033	<b>Cotter Pin 5/1, galv.</b>

123534	5.910
--------	-------

## Brace Connector RCS DW 15/M20

For mounting diagonal bracing with Tie Rod DW 15 and a compression strut to the Climbing Rail RCS.

### Complete with

2 pc. 710894 Pin Ø 25 x 180, geomet.  
4 pc. 018060 Cotter Pin 4/1, galv.

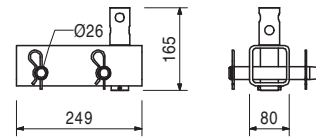
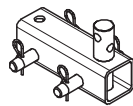

111382	35.200
--------	--------

## Climbing Rail Angle Connector RCS

For rigidly connecting the Climbing Rails RCS at right-angles, for frame construction or as bracket. With connection for the Heavy-Duty Spindle SLS and Tie Rod Cylinder Yoke SRU.

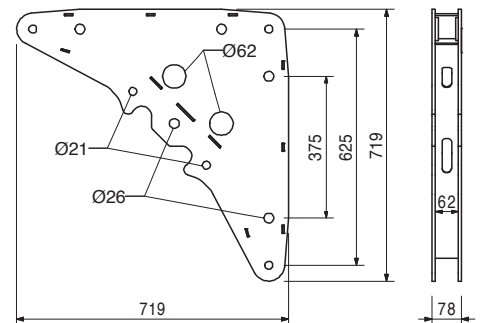
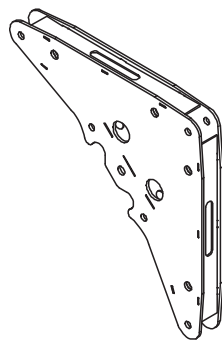

### Accessories

104031	0.462	<b>Fitting Pin Ø 21 x 120</b>
018060	0.030	<b>Cotter Pin 4/1, galv.</b>
111567	0.729	<b>Fitting Pin Ø 26 x 120</b>
022230	0.033	<b>Cotter Pin 5/1, galv.</b>
110755	5.140	<b>Tie Yoke SRU</b>

Item no. Weight kg

104031 0.462

**Fitting Pin Ø 21 x 120**  
For different connections.

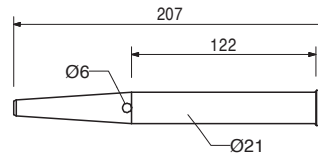
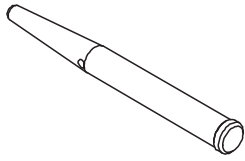

Accessories

018060 0.030

**Cotter Pin 4/1, galv.**

018060 0.030

**Cotter Pin 4/1, galv.**



111567 0.729

**Fitting Pin Ø 26 x 120**  
For different connections.

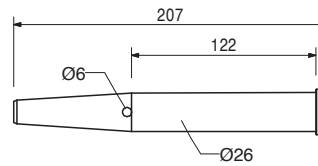
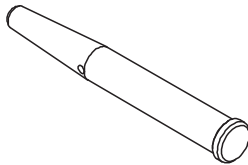

Accessories

022230 0.033

**Cotter Pin 5/1, galv.**

022230 0.033

**Cotter Pin 5/1, galv.**





Item no.	Weight kg
118094	159.000

## Crossbeam Unit RCS 220 VARIO

Platform Beam for RCS climbing formwork.  
Assembly unit of Crossbeam RCS 220,  
Crossbeam Head RCS/VARIO and Carriage RCS.

## Complete with

- 1 pc. 109716 Crossbeam RCS 220
- 1 pc. 110015 Crossbeam Head RCS/VARIO
- 1 pc. 109968 Carriage RCS
- 1 pc. 109612 Bolt ISO 4014 M24 x 130-8.8, galv.
- 1 pc. 105032 Nut ISO 7042 M24-8, galv.
- 1 pc. 104477 Bolt ISO 4014 M20 x 120-8.8, galv.
- 1 pc. 781053 Nut ISO 7042 M20-8, galv.

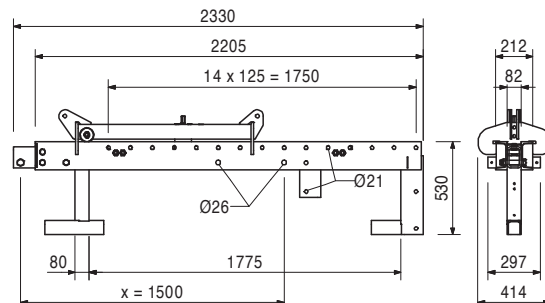
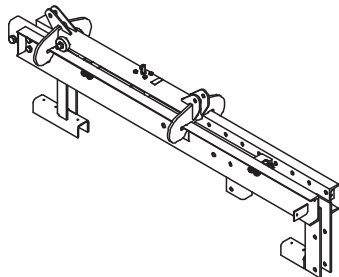

## Accessories

110094	0.895
710240	0.050
024390	0.090
024470	0.008
109720	26.600

## Carriage Crank Lever SW 19

**F.H. Bolt DIN 603 M8 x 100 MU, galv.**

**F.H. Bolt DIN 603 M8 x 200 MU, galv.**

**TSS-Torx 6 x 60, galv.**

**Guardrail Post RCS 226**

110285	7.920
--------	-------

## Crossbeam Head RCS/TRIO

For connecting the Crossbeam RCS 220 to the  
Climbing Rail RCS when using TRIO formwork  
(x = 1364).

## Complete with

- 1 pc. 109612 Bolt ISO 4014 M24 x 130-8.8, galv.
- 1 pc. 105032 Nut ISO 7042 M24-8, galv.
- 3 pc. 104477 Bolt ISO 4014 M20 x 120-8.8, galv.
- 3 pc. 781053 Nut ISO 7042 M20-8, galv.

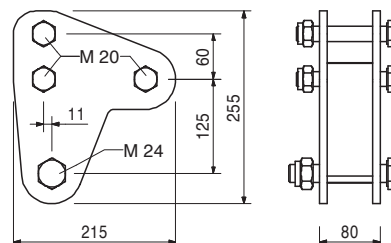
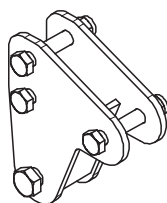

116477	10.600
--------	--------

## Platform Beam Support RCS

Support for additional Platform Beams 2 x GT 24  
or VT 20 when used with Cross Beam RCS 220.  
With connector for Guardrail Post RCS.

## Complete with

- 1 pc. 109612 Bolt ISO 4014 M24 x 130-8.8, galv.
- 1 pc. 105032 Nut ISO 7042 M24-8, galv.

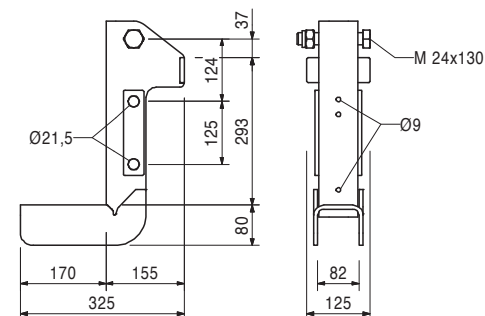
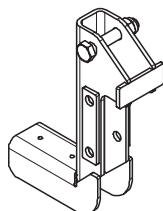

Item no.	Weight kg
109717	59.300

**Intermediate Platform Beam RCS 241**  
Platform beam for climbing platform.

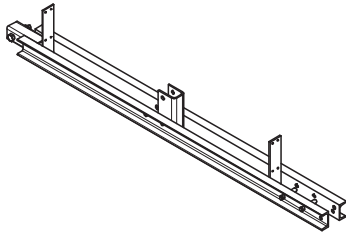

**Complete with**

- 1 pc. 109612 Bolt ISO 4014 M24 x 130-8.8, galv.
- 1 pc. 105032 Nut ISO 7042 M24-8, galv.
- 2 pc. 104031 Fitting Pin Ø 21 x 120
- 2 pc. 018060 Cotter Pin 4/1, galv.

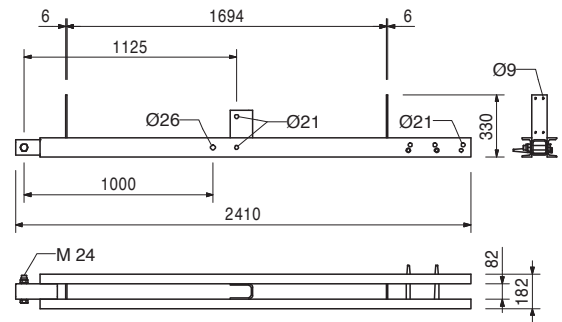

Accessories

710240	0.050
024390	0.090

**F.H. Bolt DIN 603 M8 x 100 MU, galv.**  
**F.H. Bolt DIN 603 M8 x 200 MU, galv.**

109722	14.200
--------	--------

**Finishing Platform Beam RCS 122**  
Platform beam for finishing platform.

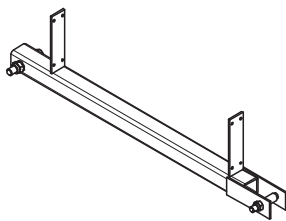

**Complete with**

- 1 pc. 104477 Bolt ISO 4014 M20 x 120-8.8, galv.
- 1 pc. 781053 Nut ISO 7042 M20-8, galv.
- 1 pc. 109612 Bolt ISO 4014 M24 x 130-8.8, galv.
- 1 pc. 105032 Nut ISO 7042 M24-8, galv.

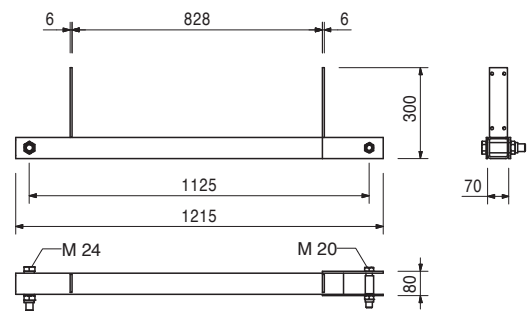

Accessories

710240	0.050
024390	0.090

**F.H. Bolt DIN 603 M8 x 100 MU, galv.**  
**F.H. Bolt DIN 603 M8 x 200 MU, galv.**

109718	16.500
110012	23.400

**Diagonal Struts RCS**  
**Diagonal Strut RCS 142**  
**Diagonal Strut RCS 212**  
For bracing RCS framework brackets.



L	X	Y
1512	1000	1000
2217	1500	1500

**Complete with**

- 2 pc. 109612 Bolt ISO 4014 M24 x 130-8.8, galv.
- 2 pc. 105032 Nut ISO 7042 M24-8, galv.

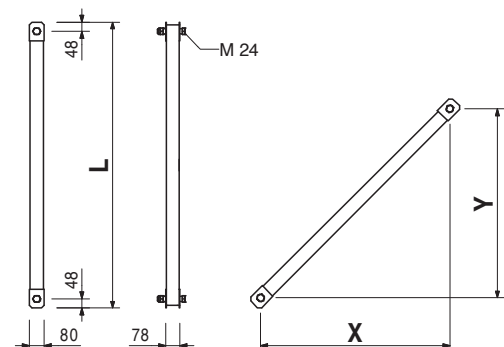

Item no.	Weight kg
114301	17.100

## Platform Beam RCS/SRU 113

For assembling cantilvered platforms on Steel Walers SRU or Climbing Rails RCS.

### Complete with

- 2 pc. 104031 Fitting Pin  $\varnothing 21 \times 120$
- 2 pc. 706454 Washer ISO 7089 200 HV, A 20, galv.
- 2 pc. 022230 Cotter Pin 5/1, galv.
- 2 pc. 706458 Bolt ISO 4017 M20  $\times 40-8.8$ , galv.
- 2 pc. 781053 Nut ISO 7042 M20-8, galv.

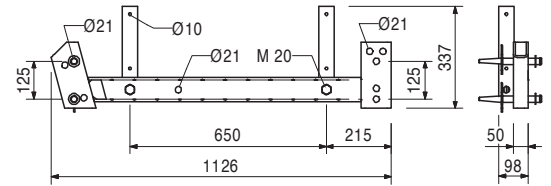
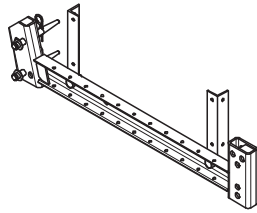

Accessories

114328	16.600
--------	--------

## Guardrail Post RCS/SRU 184

114328	16.600
--------	--------

## Guardrail Post RCS/SRU 184

For assembly of the guardrail on the Platform Beam RCS/SRU or Angle connector RCS/SRU.

### Complete with

- 2 pc. 114727 Bolt ISO 4017 M20  $\times 100-8.8$ , galv.
- 2 pc. 781053 Nut ISO 7042 M20-8, galv.

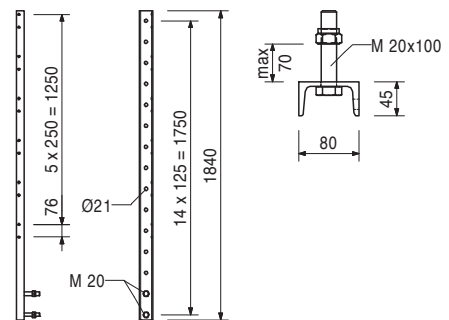

109720	26.600
--------	--------

## Guardrail Post RCS 226

For assembly of the guardrail on the main platform with RCS formwork scaffolding or as horizontal strut in the bracing.

### Complete with

- 2 pc. 104477 Bolt ISO 4014 M20  $\times 120-8.8$ , galv.
- 2 pc. 781053 Nut ISO 7042 M20-8, galv.

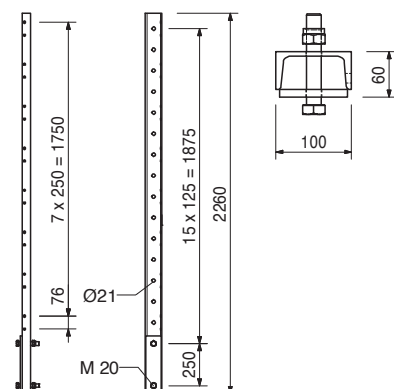



Item no.	Weight kg
109721	40.700
109773	67.900

**Guardrail Posts RCS**  
**Guardrail Post RCS 384**  
**Guardrail Post RCS 509**

For assembly of the guardrail on the intermediate and finishing platforms with RCS formwork scaffolding or as horizontal strut in the bracing.

**Complete with**

- 1 pc. 104477 Bolt ISO 4014 M20 x 120-8.8, galv.
- 1 pc. 781053 Nut ISO 7042 M20-8, galv.

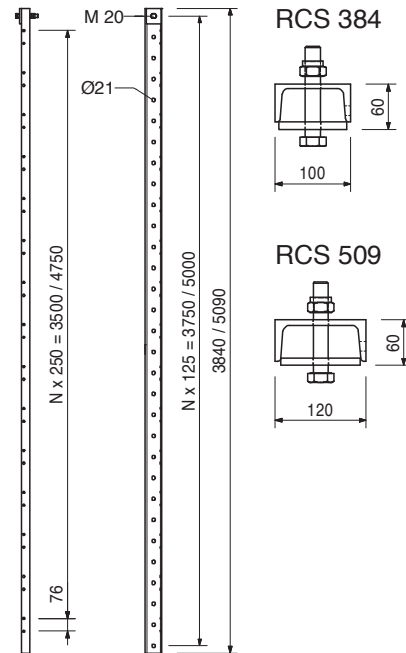

126088	4.390
--------	-------

**Guardrail Post Holder MULTI**

For fixing of an end guardrail post on Girders GT 24, VT 20 or Timbers 80/160. Fixing of the guardrail posts by means of Hex. Bolts M20 or Clamp A64.

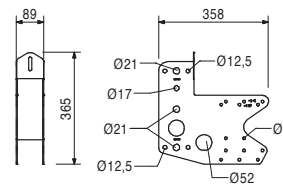
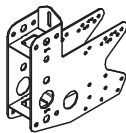

710285	0.050
024090	0.005
024470	0.008

Accessories

- Bolt ISO 4014 M8 x 100-8.8, galv.**
- Nut ISO 4032 M8-8, galv.**
- TSS-Torx 6 x 60, galv.**

Item no.	Weight kg		A	min. L	max. L
111035	12.100	<b>Heavy Duty Spindles SLS</b>	344	400	800
101773	14.700	<b>Heavy Duty Spindle SLS 40/80</b>	746	800	1400
101774	18.200	<b>Heavy Duty Spindle SLS 80/140</b>	946	1000	1800
101776	24.700	<b>Heavy Duty Spindle SLS 140/240</b>	1346	1400	2400
101778	32.100	<b>Heavy Duty Spindle SLS 200/300</b>	1944	2000	3000
101779	38.300	<b>Heavy Duty Spindle SLS 260/360</b>	2544	2600	3600
109726	44.600	<b>Heavy Duty Spindle SLS 320/420</b>	3144	3200	4200
109785	50.800	<b>Heavy Duty Spindle SLS 380/480</b>	3744	3800	4800

Used as adjustable spindle for truss beams made of Steel Walers SRU and Climbing Rails RCS.

**Note**

Permissible load see PERI Design Tables.

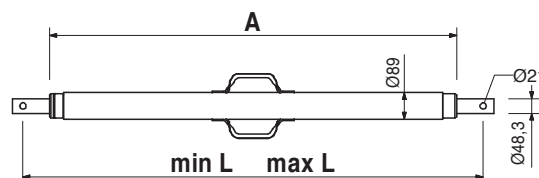
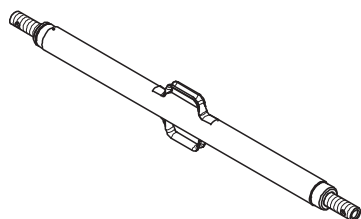

Accessories

104031	0.462	<b>Fitting Pin Ø 21 x 120</b>
018060	0.030	<b>Cotter Pin 4/1, galv.</b>
110477	3.990	<b>Spindle Adapter SLS/RCS</b>

110477	3.990	<b>Spindle Adapter SLS/RCS</b>	<b>Complete with</b>
		For connecting the Heavy-Duty Spindle SLS to the Climbing Rail RCS.	1 pc. 104031 Fitting Pin Ø 21 x 120
			1 pc. 018060 Cotter Pin 4/1, galv.

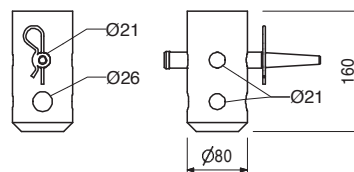
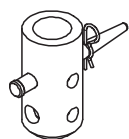

Accessories

104031	0.462	<b>Fitting Pin Ø 21 x 120</b>
018060	0.030	<b>Cotter Pin 4/1, galv.</b>
111567	0.729	<b>Fitting Pin Ø 26 x 120</b>
022230	0.033	<b>Cotter Pin 5/1, galv.</b>

Item no.	Weight kg		L
		<b>Steel Walers Universal SRU U120</b>	
103868	18.100	<b>Steel Waler Universal SRU U120, l = 0.72 m</b>	722
103871	24.200	<b>Steel Waler Universal SRU U120, l = 0.97 m</b>	972
103874	30.900	<b>Steel Waler Universal SRU U120, l = 1.22 m</b>	1222
103877	38.100	<b>Steel Waler Universal SRU U120, l = 1.47 m</b>	1472
103886	44.700	<b>Steel Waler Universal SRU U120, l = 1.72 m</b>	1722
103889	52.000	<b>Steel Waler Universal SRU U120, l = 1.97 m</b>	1972
103898	58.600	<b>Steel Waler Universal SRU U120, l = 2.22 m</b>	2222
103892	65.600	<b>Steel Waler Universal SRU U120, l = 2.47 m</b>	2472
103929	72.000	<b>Steel Waler Universal SRU U120, l = 2.72 m</b>	2722
103903	81.000	<b>Steel Waler Universal SRU U120, l = 2.97 m</b>	2972
103906	92.600	<b>Steel Waler Universal SRU U120, l = 3.47 m</b>	3472
103915	106.000	<b>Steel Waler Universal SRU U120, l = 3.97 m</b>	3972
103918	119.000	<b>Steel Waler Universal SRU U120, l = 4.47 m</b>	4472
103922	135.000	<b>Steel Waler Universal SRU U120, l = 4.97 m</b>	4972
103925	146.000	<b>Steel Waler Universal SRU U120, l = 5.47 m</b>	5472
103928	159.000	<b>Steel Waler Universal SRU U120, l = 5.97 m</b>	5972

Universal steel waler profile U120 used as waling for girder wall formwork and for diverse special applications. With adjustable spacers.

**Note**  
Permissible load: see PERI Design Tables.

**Technical Data**  
U120:  $W_y = 121.4 \text{ cm}^3$ ,  $I_y = 728 \text{ cm}^4$ .

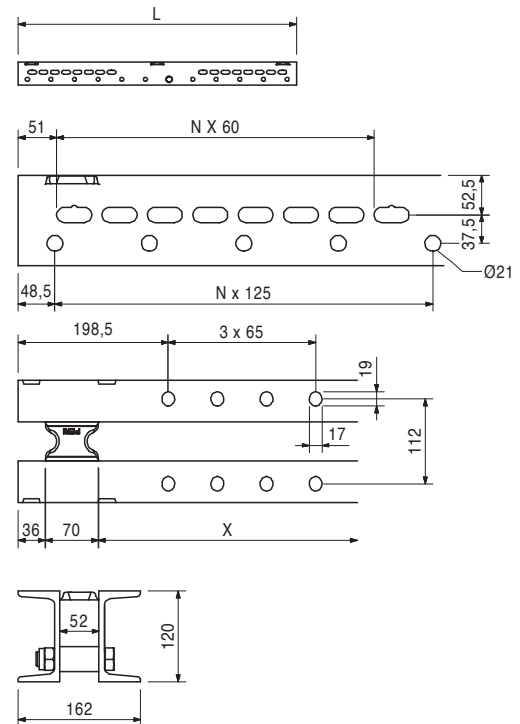
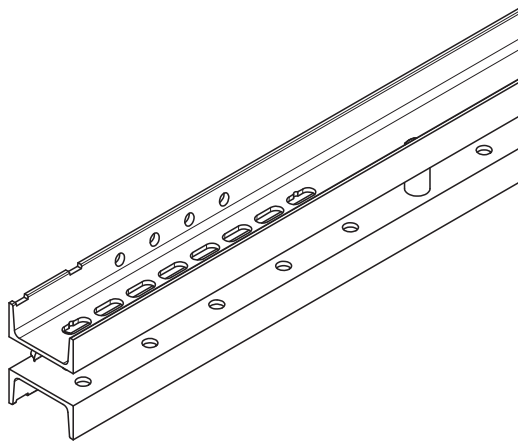

020620 0.561

**Spacer for Platform Beam BR**  
For Platform Beam BR or Steel Walers SRU.

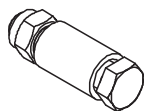

**Complete with**

1 pc. 710226 Bolt ISO 4014 M20 x 90-8.8, galv.  
1 pc. 781053 Nut ISO 7042 M20-8, galv.

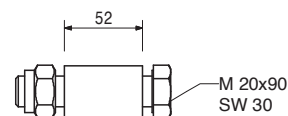



Item no.	Weight kg
110059	2.840

## Waler Fixation U100 – U120

For fixing VARIO GT 24 panels to Strongbacks CB, SCS and Steel Waler SRU.

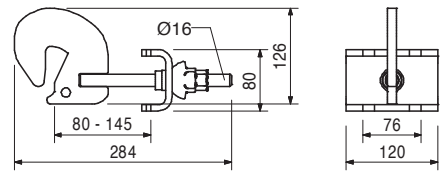
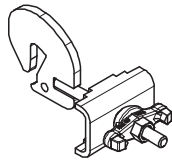

110400	7.160
--------	-------

## Adjusting Unit SRU, external

For the external height adjustment of the formwork element at the strongback (Steel Waler SRU).

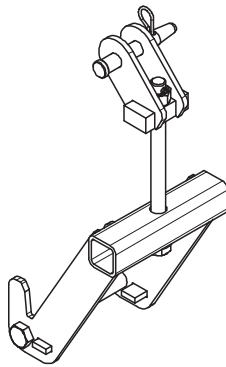

### Complete with

- 1 pc. 105400 Pin Ø 20 x 140, galv.
- 1 pc. 018060 Cotter Pin 4/1, galv.
- 1 pc. 706454 Washer ISO 7089 200 HV, A 20, galv.
- 1 pc. 110637 Schr. ISO 4017-M20X260 BEARB.
- 1 pc. 780807 Sleeve ISO8752-08, 0 x 028, galv.

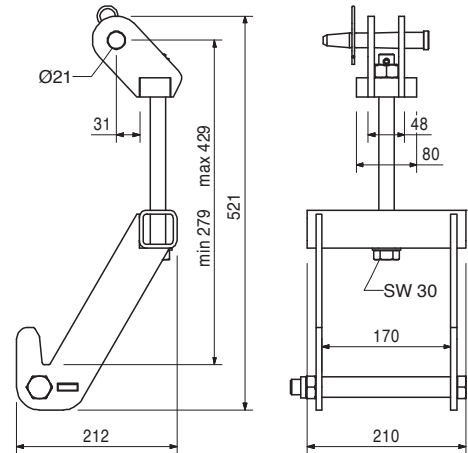

111135	5.620
--------	-------

## Adjusting Unit SRU, internal

For internal height adjustment of the formwork on the strongback (Steel Waler SRU).

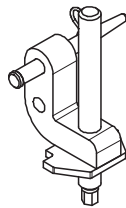

### Complete with

- 1 pc. 105400 Pin Ø 20 x 140, galv.
- 1 pc. 018060 Cotter Pin 4/1, galv.

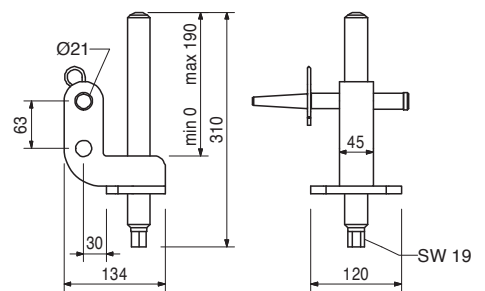

Item no.	Weight kg
115325	16.600

### Strongback Adapter RCS/SRU

For mounting the Strongback SRU to the Carriage RCS when used with TRIO.

### Complete with

2 pc. 105400 Pin  $\varnothing$  20 x 140, galv.  
2 pc. 018060 Cotter Pin 4/1, galv.

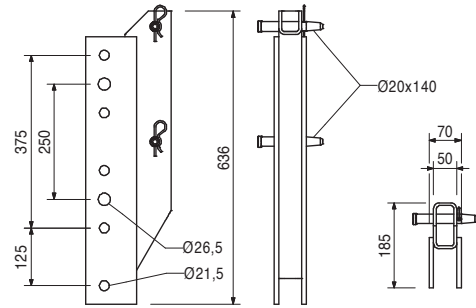
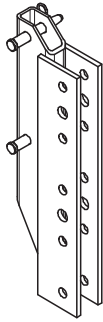

115623	5.060
--------	-------

### Connector SRU VARIOKIT

For a rigid connection of Steel Walers SRU.

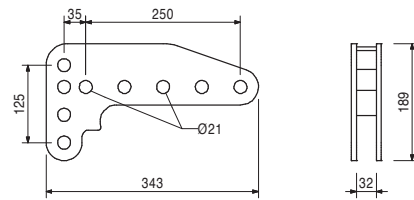
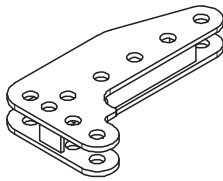

### Accessories

104031	0.462
018060	0.030

**Fitting Pin  $\varnothing$  21 x 120**  
**Cotter Pin 4/1, galv.**

111403	4.840
--------	-------

### Mounting Castor Climbing Rail RCS

For mounting and moving formwork elements on horizontally-positioned Climbing Rails RCS.

### Technical Data

Permissible load-bearing capacity 1.5 t.

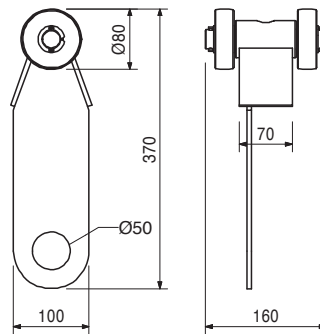
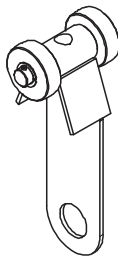

057050	4.450
--------	-------

### Suspension Tube Vario 53

For attaching VARIO GT 24 elements.

### Complete with

2 pc. 710593 Bolt ISO 4014 M10 x 80-8.8, galv.  
2 pc. 710234 Nut ISO 4032 M10-8, galv.

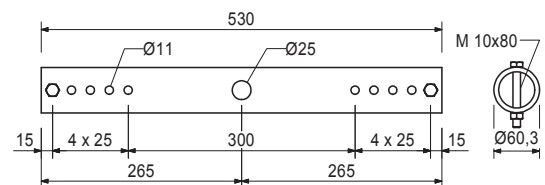
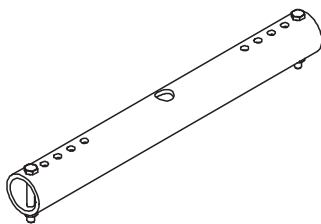

Item no.	Weight kg
125823	2.170

## Formwork Suspension VARIO GT 24, Ø 60

For connecting the Suspension Tube VARIO 53 to Formwork Girders GT 24.

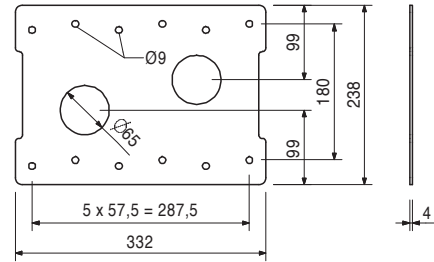
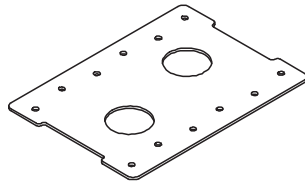

024540	0.005
024470	0.008

### Accessories

**TSS-Torx 6 x 40, galv.**  
**TSS-Torx 6 x 60, galv.**

111631	10.100
--------	--------

## Crossbar RCS 69

As horizontal bar or strut for assembly as Climbing Protection Panel (platform width 1.00 m).

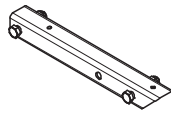

### Complete with

2 pc. 109612 Bolt ISO 4014 M24 x 130-8.8, galv.  
 2 pc. 105032 Nut ISO 7042 M24-8, galv.

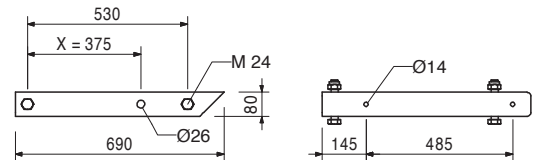

710330	0.017
113348	0.043
110599	0.242

### Accessories

**Nut ISO 4032 M12-8, galv.**  
**Washer ISO 7094 100 HV, A 12, galv.**  
**Bolt ISO 4017 M12 x 240-8.8, galv.**

110234	18.200
--------	--------

## Crossbar RCS 103

As horizontal bar for assembly as Climbing Protection Panel (platform width 1.32 m).

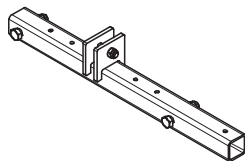

### Complete with

1 pc. 710226 Bolt ISO 4014 M20 x 90-8.8, galv.  
 1 pc. 781053 Nut ISO 7042 M20-8, galv.  
 2 pc. 109612 Bolt ISO 4014 M24 x 130-8.8, galv.  
 2 pc. 105032 Nut ISO 7042 M24-8, galv.

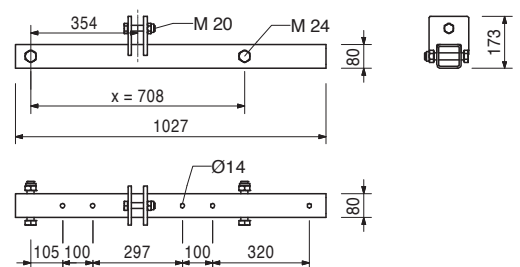

710330	0.017
113348	0.043
110599	0.242

### Accessories

**Nut ISO 4032 M12-8, galv.**  
**Washer ISO 7094 100 HV, A 12, galv.**  
**Bolt ISO 4017 M12 x 240-8.8, galv.**



Item no.	Weight kg
110012	23.400

**Diagonal Strut RCS 212**  
For bracing RCS framework brackets.

**Complete with**  
2 pc. 109612 Bolt ISO 4014 M24 x 130-8.8, galv.  
1 pc. 105032 Nut ISO 7042 M24-8, galv.

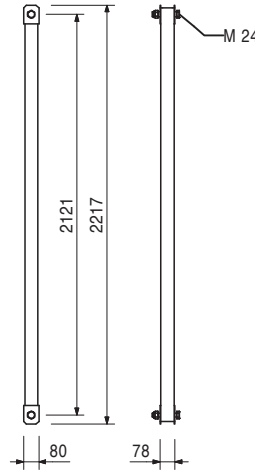
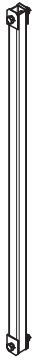

128671	19.100
--------	--------

**Climbing Rail Connector RCS/LPS 73**  
For height extension of Climbing Rails RCS in combination with Screen Elements LPS.

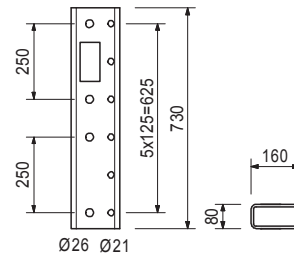

Accessories

127875	1.960
--------	-------

**Screen Support LPS M20**

127875	1.960
--------	-------

**Screen Support LPS M20**  
For vertical support of Screen elements LPS in combination with Climbing Rail Connector RCS/LPS 73.

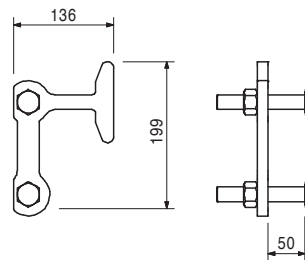
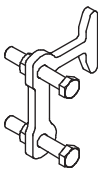

Item no.	Weight kg
110290	5.030

## Timber Fixation RCS 12/20

For assembly of timbers on the Climbing Rails RCS for use as climbing protection panel.

## Complete with

1 pc. 110281 Eye Bolt M20, right, galv.  
1 pc. 781053 Nut ISO 7042 M20-8, galv.

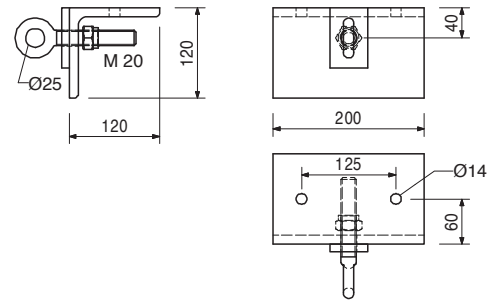
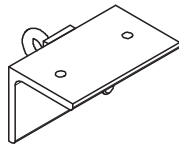

## Accessories

070030	0.015	<b>Bulldog-Spike Ø 48/12 mm</b>
018330	0.140	<b>Bolt ISO 4016 M12 x 140-4.6 MU, galv.</b>
027340	0.180	<b>Bolt ISO 4016 M12 x 180-4.6 MU, galv.</b>
113348	0.043	<b>Washer ISO 7094 100 HV, A 12, galv.</b>

126430	4.460
--------	-------

## Adapter VT 20 / RCS-P

For mounting a horizontal positioned girder VT 20 onto the climbing profile RCS.

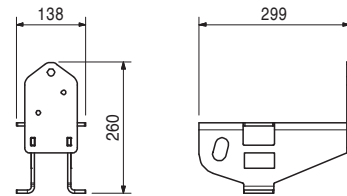
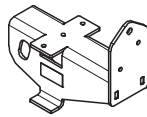

## Accessories

024470	0.008	<b>TSS-Torx 6 x 60, galv.</b>
109612	0.600	<b>Bolt ISO 4014 M24 x 130-8.8, galv.</b>
105032	0.070	<b>Nut ISO 7042 M24-8, galv.</b>
104477	0.300	<b>Bolt ISO 4014 M20 x 120-8.8, galv.</b>
781053	0.065	<b>Nut ISO 7042 M20-8, galv.</b>

127568	41.000
127572	47.600
127576	54.500
127580	77.600

## Screen Elements DX LPS

**Screen Element DX LPS 250 x 123**  
**Screen Element DX LPS 300 x 123**  
**Screen Element DX LPS 350 x 123**  
**Screen Element DX LPS 500 x 123**

Standard protection panels. Duplex coated.  
Mesh size 40 x 17 x 3.

## L

2500  
3000  
3500  
5000

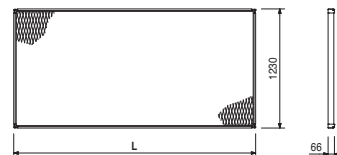
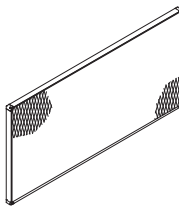

Item no.	Weight kg
127556	46.500

## Telescopic Screen LPS 123 x 248, DX

Mesh protection panel with telescopic function or as side protection on Material platforms RCS-MP. Duplex coated. Mesh size 40 x 17 x 3.

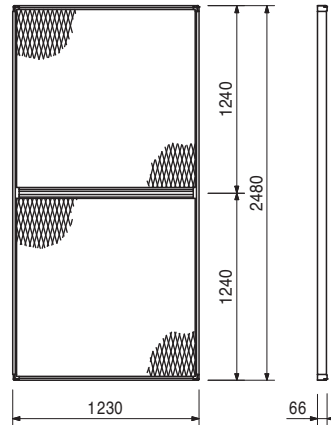
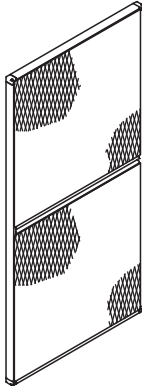

127560	69.900
--------	--------

## Telescopic Screen LPS 123 x 373, DX

Mesh protection panel with telescopic function or as side protection on Material platforms RCS-MP. Duplex coated. Mesh size 40 x 17 x 3.

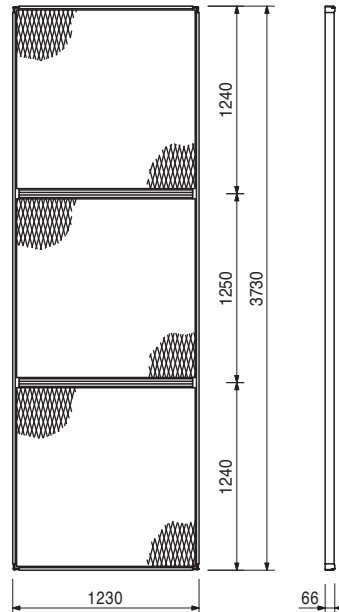
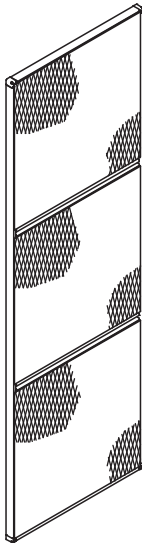



Item no.	Weight kg
127564	93.100

## Telescopic Screen DX LPS 123 x 498

Mesh protection panel with telescopic function.  
Duplex coated. Mesh size 40 x 17 x 3.

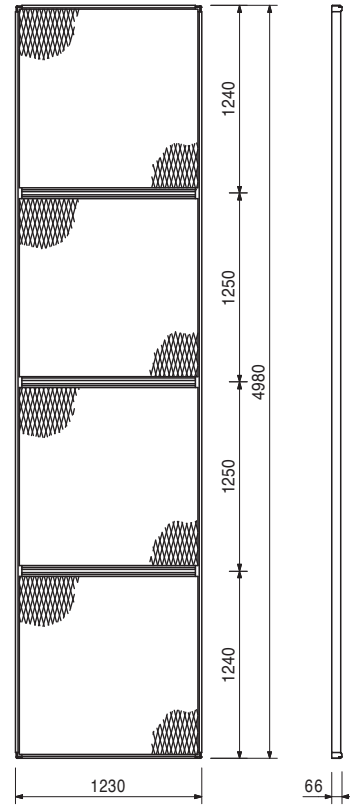
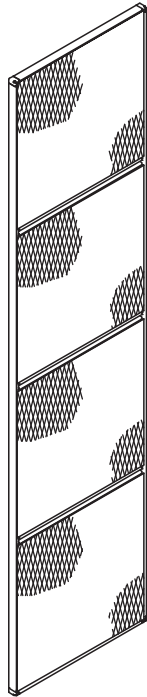

117166	2.290
--------	-------

## Screen Adapter Single LPS 60

For connection of single Screen Element LPS to Climbing Rail LPS or RCS.

### Note

Wrench size SW 24.

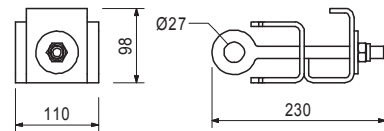
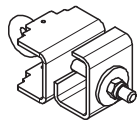

### Accessories

710226	0.340	<b>Bolt ISO 4014 M20 x 90-8.8, galv.</b>
781053	0.065	<b>Nut ISO 7042 M20-8, galv.</b>
104031	0.462	<b>Fitting Pin Ø 21 x 120</b>
022230	0.033	<b>Cotter Pin 5/1, galv.</b>

117152	2.150
--------	-------

## Screen Adapter Double LPS 60

For connection of two standard Screen Elements LPS to Climbing Rail LPS or RCS.

### Note

Wrench size SW 24.

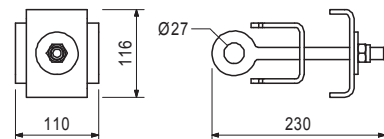
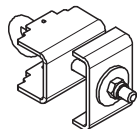

### Accessories

710226	0.340	<b>Bolt ISO 4014 M20 x 90-8.8, galv.</b>
781053	0.065	<b>Nut ISO 7042 M20-8, galv.</b>
104031	0.462	<b>Fitting Pin Ø 21 x 120</b>
022230	0.033	<b>Cotter Pin 5/1, galv.</b>

Item no.	Weight kg
127600	2.350

### Screen Adapter Telescope-2 LPS

For connection of Telescopic Screen LPS to standard Screen Element LPS. Telescopic range max. 1.05 m.

### Note

Wrench size SW 24.

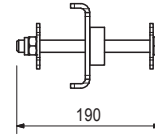
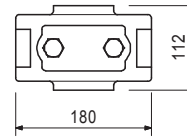
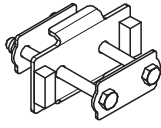

117165	5.050
--------	-------

### Screen Adapter Combi LPS 60

For connection of Telescopic Screen LPS to standard Screen Element LPS and to Climbing Rail LPS or RCS.

### Note

Wrench size SW 24.

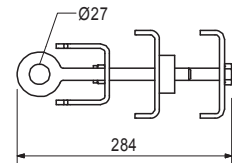
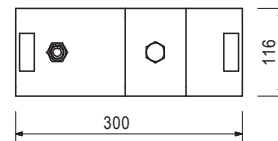
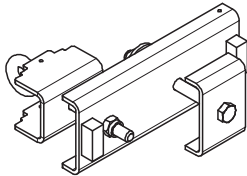

### Accessories

710226	0.340
781053	0.065
104031	0.462
022230	0.033

**Bolt ISO 4014 M20 x 90-8.8, galv.**

**Nut ISO 7042 M20-8, galv.**

**Fitting Pin Ø 21 x 120**

**Cotter Pin 5/1, galv.**

117535	4.650
--------	-------

### Screen Adapter Corner LPS

For right angle connection of Telescopic Screen LPS to other screen elements.

### Note

Wrench size SW 24.

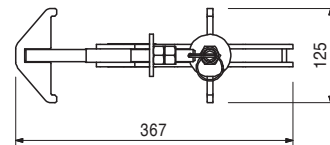
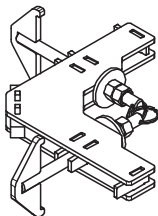

128842	1.820
--------	-------

### Edge Screen Adapter Telescop LPS

For the edge connection of telescopic screens to standard Screen Elements LPS. Telescopic range max. 1.05 m.

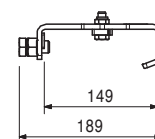
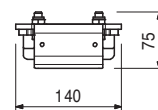

Item no.	Weight kg
128804	3.150

**Edge Screen Adapter Corner LPS**  
 For right-angled edge connection of Telescopic Screens LPS to other screen elements.

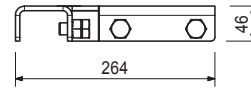
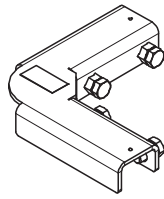

125971	2.300
125945	3.460

**Cover Strips LPS**  
**Cover Strip LPS 20 x 248**  
**Cover Strip LPS 20 x 373**

Elastic covering for closing gaps between screen elements.

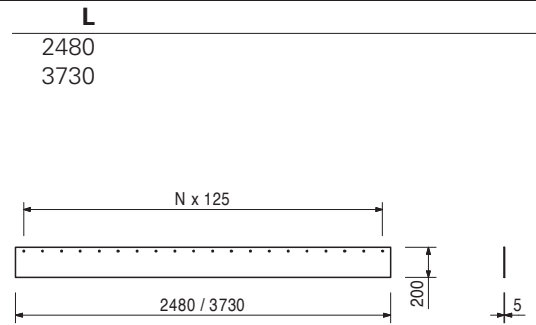
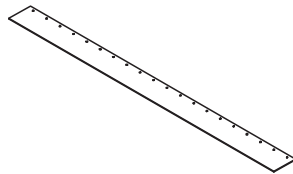

126268	0.003
--------	-------

Accessories  
**Cable Binder PA 6.6 SW 203 x 7.6**

126268	0.003
--------	-------

**Cable Binder PA 6.6 SW 203 x 7.6**

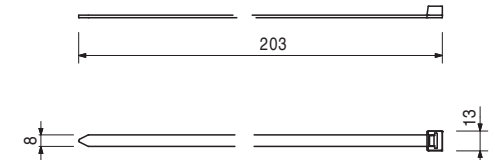
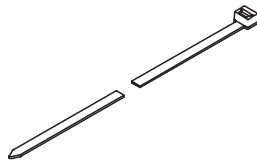



Item no.	Weight kg
127053	0.806

## Cover Clip Profile LPS 112

For fixation of elastic covering of gaps between climbing units with mesh panel enclosure LPS.

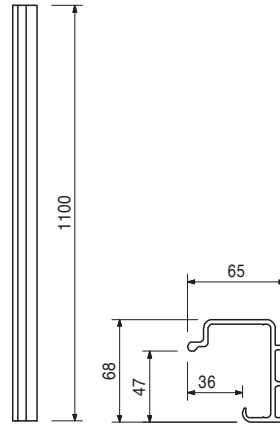

### Accessories

127060	7.500
127061	17.250

## Draw-in Profile LPS 20/55, l = 15 m

## Draw-in Profile LPS 18/93, l = 15 m

127060	7.500
--------	-------

## Draw-in Profile LPS 20/55, l = 15 m

Elastic rubber profile to cover gaps up to 50 mm.

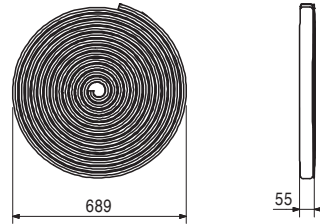

127061	17.250
--------	--------

## Draw-in Profile LPS 18/93, l = 15 m

Elastic rubber profile to cover gaps up to 90 mm.

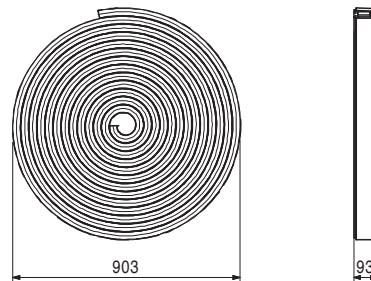

Item no.	Weight kg		L
		<b>Scaffold Tubes Steel Ø 48.3</b>	
026415	3.550	<b>Scaff. Tube Steel Ø 48.3 x 3.2, special length</b>	
026417	0.000	<b>Cutting Cost Scaffold Tube</b>	
026411	3.550	<b>Scaff. Tube Steel Ø 48.3 x 3.2, l = 1.0 m</b>	1000
026412	7.100	<b>Scaff. Tube Steel Ø 48.3 x 3.2, l = 2.0 m</b>	2000
125976	8.900	<b>Scaff. Tube Steel Ø 48.3 x 3.2, l = 2.5 m</b>	2500
026413	10.650	<b>Scaff. Tube Steel Ø 48.3 x 3.2, l = 3.0 m</b>	3000
114287	12.500	<b>Scaff. Tube Steel Ø 48.3 x 3.2, l = 3.5 m</b>	3500
026414	14.200	<b>Scaff. Tube Steel Ø 48.3 x 3.2, l = 4.0 m</b>	4000
026419	17.750	<b>Scaff. Tube Steel Ø 48.3 x 3.2, l = 5.0 m</b>	5000
026418	21.600	<b>Scaff. Tube Steel Ø 48.3 x 3.2, l = 6.0 m</b>	6000

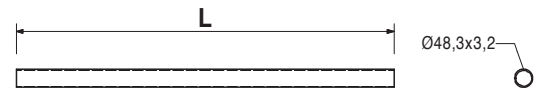
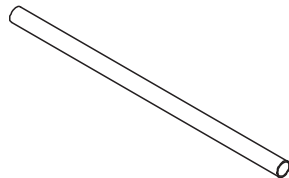

017010	1.400	<b>Swivel Coupling DK 48/48, galv.</b> For Scaffold Tubes Ø 48 mm.
--------	-------	---

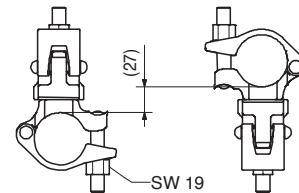
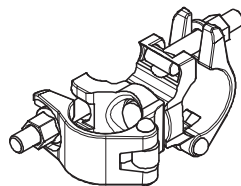

017020	1.120	<b>Standard Coupler NK 48/48, galv.</b> For Scaffold Tubes Ø 48 mm.
--------	-------	--

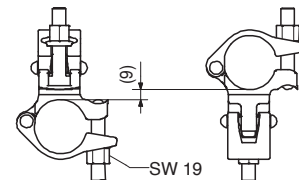
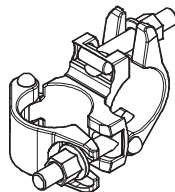

110084	2.310	<b>Scaffold Tube Adapter Ø 48 RCS</b> For connecting Scaffold Tubes Ø 48 mm to Climbing Rails RCS.
--------	-------	---

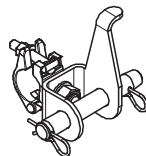

**Complete with**  
 1 pc. 017040 Screw-On Coupler AK 48, galv.  
 1 pc. 710894 Pin Ø 25 x 180, geomet.  
 2 pc. 018060 Cotter Pin 4/1, galv.

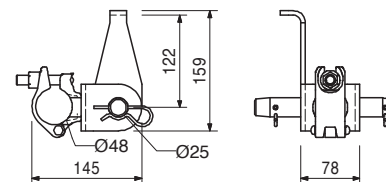

# RCS Rail Climbing System



Item no.	Weight kg
110296	0.220

**Clamp A64 DIN 3570 M12, galv.**  
For assembling Scaffold Tubes  $\varnothing$  48 or  $\varnothing$  60.

**Note**  
Wrench size SW 19.

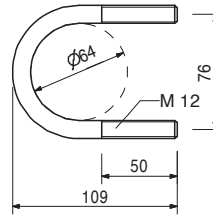
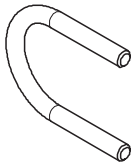

Accessories

710330	0.017
--------	-------

**Nut ISO 4032 M12-8, galv.**

710330	0.017
--------	-------

**Nut ISO 4032 M12-8, galv.**

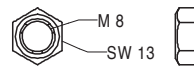

017040	0.850
--------	-------

**Screw-On Coupler AK 48, galv.**  
For Scaffold Tubes  $\varnothing$  48 mm.

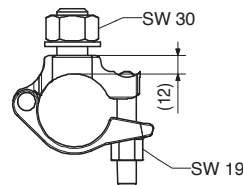
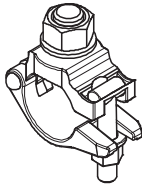

125973	12.400
--------	--------

**Cover Strip Rubber 0.20 x 10 m**  
Universal elastic covering for closing gaps between platforms.

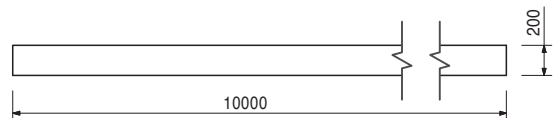
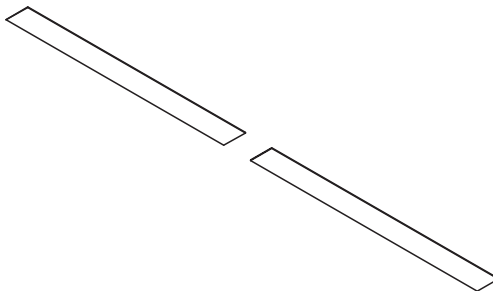

# RCS Rail Climbing System

Item no.	Weight kg
110289	4.260

**L-Angle RCS 120 x 120 x 200**  
For fixing end handrail posts on the decking.

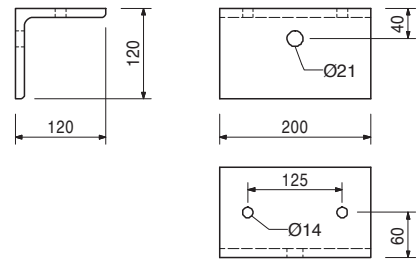
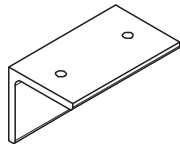

Accessories

017040	0.850
--------	-------

**Screw-On Coupler AK 48, galv.**

123478	0.255
--------	-------

**Toe Board Angle 90°**  
For diverse timber connections.

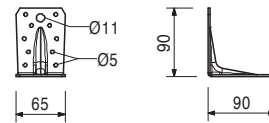

Accessories

024550	0.005
--------	-------

**Spax Screw TX 30 8 x 20, yellow galv.**

125856	2.380
--------	-------

**Scaffold Tube Adapter LPS/RCS Ø 48**  
For assembling scaffold tubes Ø 48 on Climbing Rail RCS.

**Complete with**

- 1 pc. 017040 Screw-On Coupler AK 48, galv.
- 1 pc. 710894 Pin Ø 25 x 180, geomet.
- 2 pc. 018060 Cotter Pin 4/1, galv.

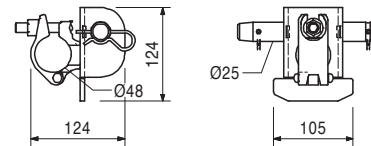
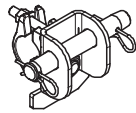

125458	0.271
--------	-------

**Flap Safety Plate LPS Ø 48**  
For safety flap up-lift protection.

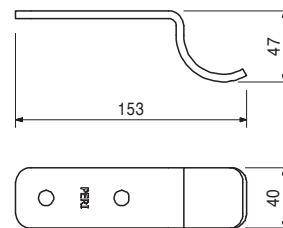
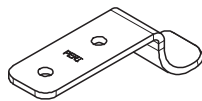

Accessories

024550	0.005
--------	-------

**Spax Screw TX 30 8 x 20, yellow galv.**



Item no.	Weight kg
125461	0.711

**Flap Hinge LPS Ø 48/M10**  
 For mounting safety flap on scaffold tubes  
 Ø 48.3 x 3.2.

**Note**  
 Wrench size SW 16.

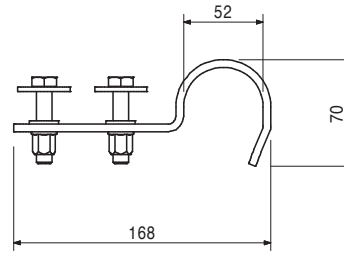
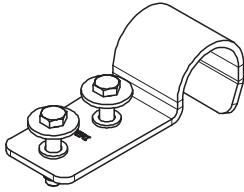

070030	0.015
--------	-------

**Bulldog-Spike Ø 48/12 mm**  
 To strengthen the timber fixation and for other connections of timber with steel.

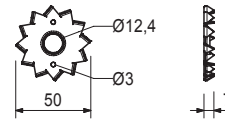

111436	0.150
--------	-------

**Hinge DIN 7957-200-ST, yellow galv.**  
 For mounting the cover flap at the climbing protection panel.

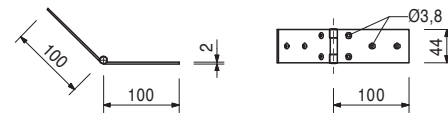
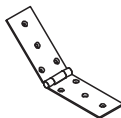

Accessories

111437	0.004
110642	0.006

**Spax Screw TX25, 5 x 20, yellow galv.**  
**Spax Screw TX25, 5 x 40, yellow galv.**

114937	0.402
--------	-------

**Fixation Bar RCS**  
 For fixing the cover flap to the climbing protection panel during climbing.

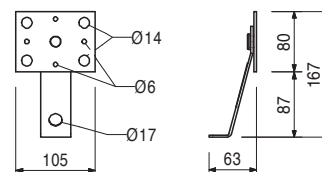
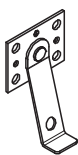

Accessories

111437	0.004
--------	-------

**Spax Screw TX25, 5 x 20, yellow galv.**

# RCS Rail Climbing System



Item no.	Weight kg
127320	163.000

**Lifting Beam 10 t**  
For moving climbing units.

**Note**  
Follow Instructions for Use.  
**Technical Data**  
Permissible load-bearing capacity 10 t.

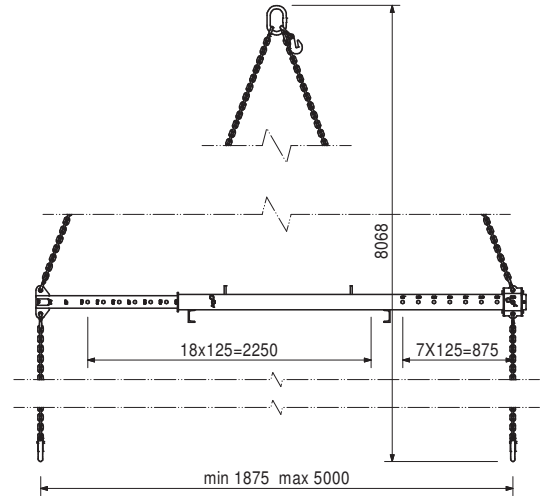
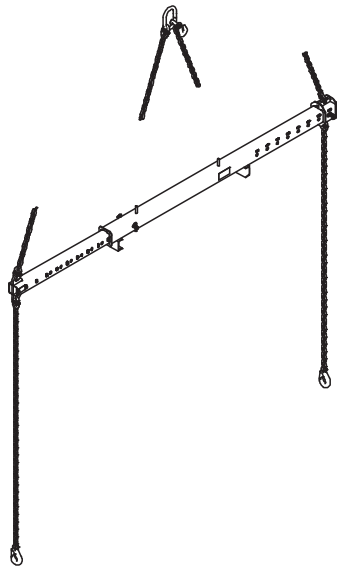

127834	2.210
--------	-------

**Crane Eye BR-2 2.5 t, galv.**  
As attachment point for moving climbing systems or Platform Beam BR.

**Note**  
Follow Instructions for Use!  
**Technical Data**  
Permissible load-bearing point capacity 2.5 t.

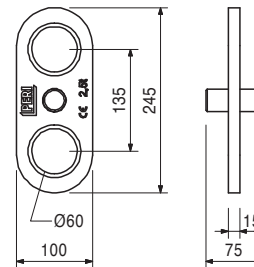

Accessories  
**Spacer for Platform Beam BR**

020620	0.561
--------	-------

Item no.	Weight kg
113745	30.200

### Climbing Rail Extension RCS 125

For extending the Climbing Rail RCS and using the Climbing Device RCS 50 on the working platform.

### Complete with

- 4 pc. 110022 Spacer M20-82
- 2 pc. 111567 Fitting Pin  $\varnothing$  26 x 120
- 2 pc. 022230 Cotter Pin 5/1, galv.

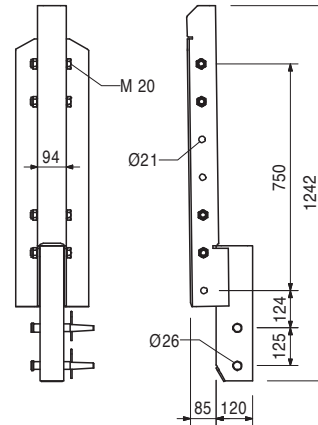

116469	5.920
--------	-------

### RCS Wheel 1.5 t

For assembling in Climbing Rails RCS, foldable.

### Complete with

- 2 pc. 113012 Pin  $\varnothing$  20 x 260, galv.
- 2 pc. 018060 Cotter Pin 4/1, galv.

### Technical Data

Permissible load-bearing capacity 1.5 t.

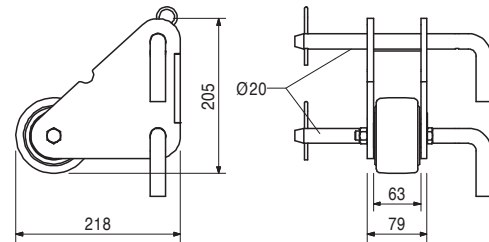
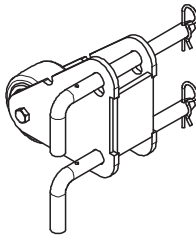

114317	3.210
--------	-------

### Guide in Tool RCS

For pulling up the Climbing Rail RCS in order to close the leading runners of the Climbing Shoe.

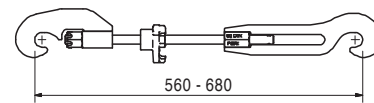
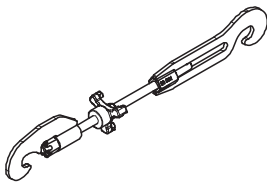

Item no.	Weight kg
109503	7.380

### Wall Shoe RCS

Anchor System M30. For anchoring Climbing Shoe RCS to the wall.

### Complete with

1 pc. 715585 Pin  $\varnothing$  25 x 240, SKS, galv.  
1 pc. 022230 Cotter Pin 5/1, galv.

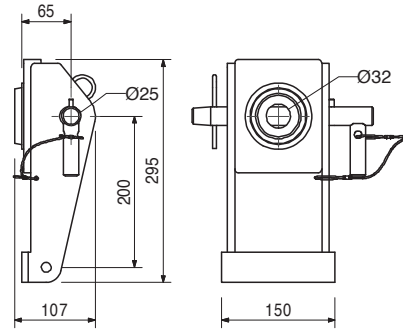
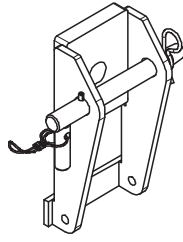

### Accessories

029420	0.590
--------	-------

**Bolt ISO 4017 M30 x 70-8.8, galv.**

110667	13.700
--------	--------

### Wall Shoe RCS, pivoted

Anchor System M30. For anchoring Climbing Shoe RCS to circular walls. Swivel range  $\pm 15^\circ$ .

### Complete with

1 pc. 715585 Pin  $\varnothing$  25 x 240, SKS, galv.  
1 pc. 022230 Cotter Pin 5/1, galv.

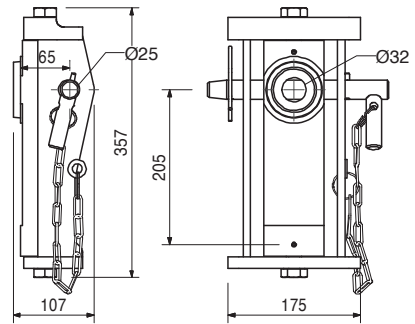
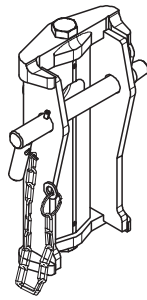

### Accessories

113007	0.700
--------	-------

**Cyl. Bolt ISO 4762 M30 x 70-8.8, galv.**



Item no.	Weight kg
110315	11.000

## Mounting Ring Adapter RCS M30

For suspension with Scaffold Mounting Ring M30 during use as unguided climbing formwork.

## Complete with

- 1 pc. 715585 Pin Ø 25 x 240, SKS, galv.
- 2 pc. 104031 Fitting Pin Ø 21 x 120
- 2 pc. 018060 Cotter Pin 4/1, galv.

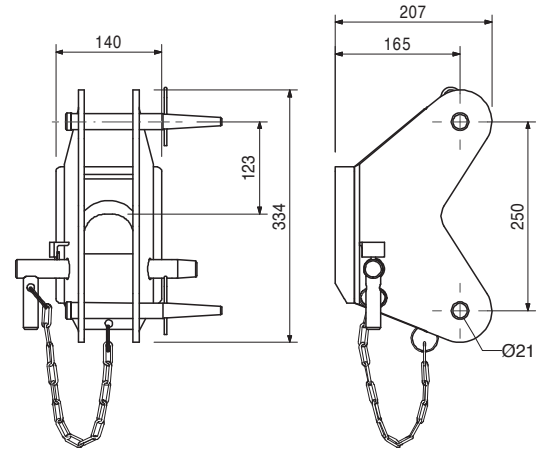
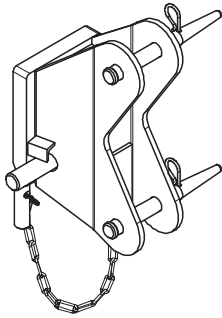

### Accessories

029480	1.830
--------	-------

## Scaffold Mounting Ring M30, galv.

029480	1.830
--------	-------

## Scaffold Mounting Ring M30, galv.

Anchor System M30.  
For anchoring climbing systems.

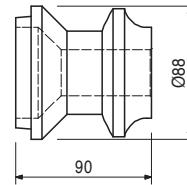
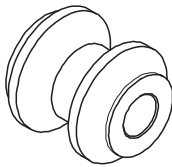

### Accessories

029540	0.920
--------	-------

## Bolt ISO 4014 M30 x 130-10.9, galv.

030920	1.650
--------	-------

## Climbing Cone-2 M30/DW 20, galv.

Anchor System M30.  
For anchoring climbing systems.

### Note

Separate design information on request.

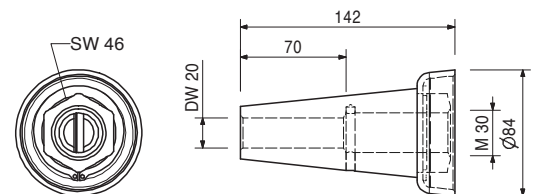
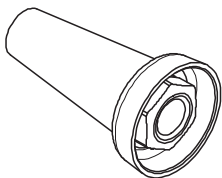

### Accessories

030860	0.792
030700	2.560
030745	2.600

## Threaded Anchor Plate DW 20

**Tie Rod DW 20, spec. length**

**Tie Rod B 20, spec. length**

Item no.	Weight kg
030860	0.792

### Threaded Anchor Plate DW 20

For use with Tie Rod DW 20, B 20 or Screw-On Cone-2 M24/DW 20. For anchoring in concrete.

### Note

Lost anchor part.

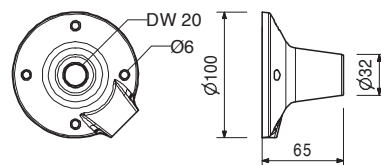
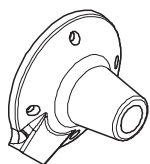

030700	2.560
030800	0.000

### Tie Rod DW 20

### Tie Rod DW 20, spec. length

### Cutting Cost Tie Rod DW 20/B 20

### Note

Non-weldable! Take official approval into consideration!

### Technical Data

Permissible tension force 150 kN.

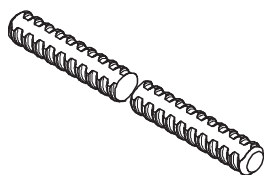

030745	2.600
030800	0.000

### Tie Rod B 20

### Tie Rod B 20, spec. length

### Cutting Cost Tie Rod DW 20/B 20

### Note

Weldable! Take official approval into consideration!

### Technical Data

Permissible tension force 150 kN.

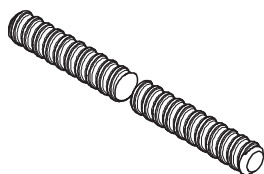

057257	1.810
--------	-------

### Screw-On Cone M30/DW 26

Anchor System M30.  
For anchoring climbing systems.

### Note

Permissible load see PERI product information.

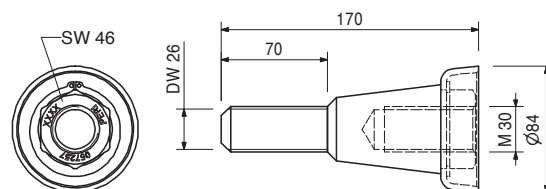
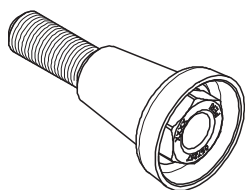

030870	1.260
--------	-------

### Accessories

### Threaded Anchor Plate DW 26

Item no.	Weight kg
030870	1.260

### Threaded Anchor Plate DW 26

For use with Tie Rod DW 26 or Screw-On Cone M36/DW 26. For anchoring in concrete.

**Note**  
Lost anchor part.

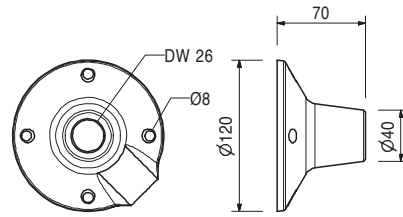
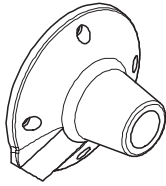

031653	0.364
--------	-------

### KK Concrete Cone M30-80/52

For closing anchor points with Climbing Cone-2 M30/DW 20 or Screw-On Cone M30/DW 26.

**Note**  
Delivery unit 50 pieces.

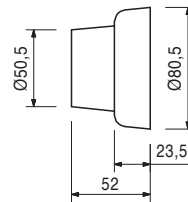
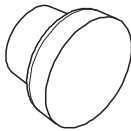

Accessories

113127	5.400
--------	-------

### Glue for Concrete Cones-3, 5,4-kg-Set

113127	5.400
--------	-------

### Glue for Concrete Cones-3, 5,4-kg-Set

For bonding PERI concrete cones.

**Note**  
See Safety Data sheet!  
Consisting of:  
6 x Component A,           6 x Component B  
2 x Stirring Container,   3 x Stirring Staff

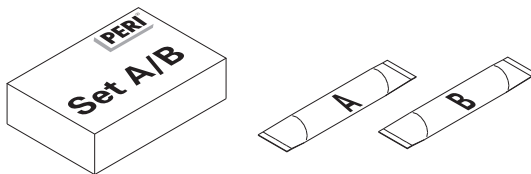

029380	0.200
--------	-------

### Anchor Positioning Plate M30, galv.

For fixing the M30 anchor system if the plywood formlining is drilled through.

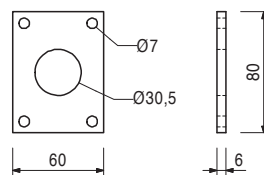
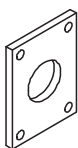

Accessories

029440	0.005
--------	-------

### Lag Screw DIN 571 6 x 20, galv.

Item no.	Weight kg
029450	0.339

### Advancing Screw M30, galv.

For fixing the M30 anchor system if the plywood formlining is drilled through.

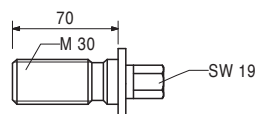
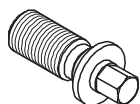

Accessories

029380	0.200
--------	-------

### Anchor Positioning Plate M30, galv.

029420	0.590
--------	-------

### Bolt ISO 4017 M30 x 70-8.8, galv.

Bolt for anchoring of climbing systems.

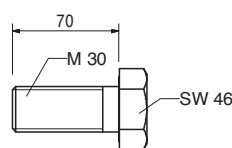
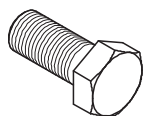

Accessories

029380	0.200
--------	-------

### Anchor Positioning Plate M30, galv.

029540	0.920
--------	-------

### Bolt ISO 4014 M30 x 130-10.9, galv.

High-strength bolt for anchoring climbing systems.

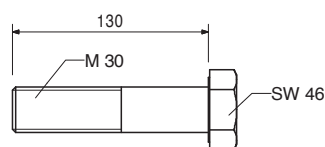
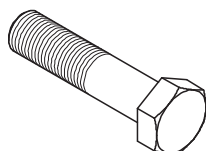

109567	20.200
--------	--------

### Slab Shoe RCS

Anchor System M24. For mounting Climbing Shoe RCS to slab edges.

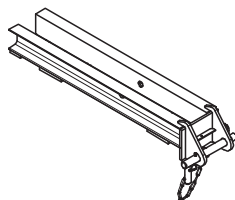

### Complete with

1 pc. 715585 Pin Ø 25 x 240, SKS, galv.

1 pc. 022230 Cotter Pin 5/1, galv.

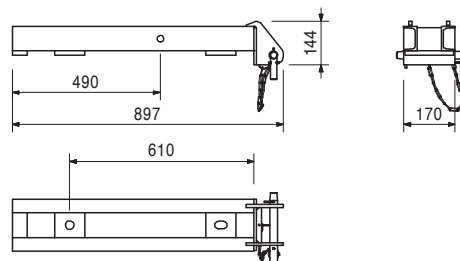



Item no.	Weight kg
110375	30.800

## Slab Shoe RCS Corner

Anchor System M24. For mounting Climbing Shoe RCS to the corners of slab edges.

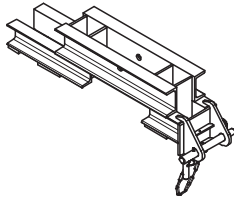

## Complete with

1 pc. 715585 Pin  $\varnothing$  25 x 240, SKS, galv.  
1 pc. 022230 Cotter Pin 5/1, galv.

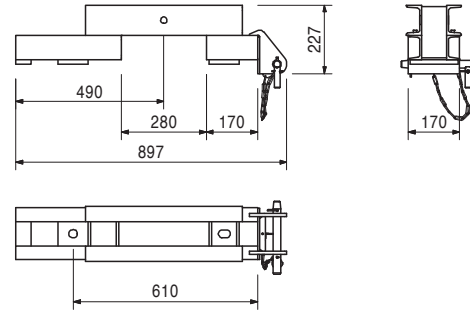

115570	54.400
--------	--------

## Slab Shoe Adjustable RCS 30

Anchor System M24.  
For mounting the Climbing Shoe RCS to slab edges. Offset up to 30 cm. Anchor distance variable  $61 \pm 5$  cm or  $76 \pm 5$  cm.

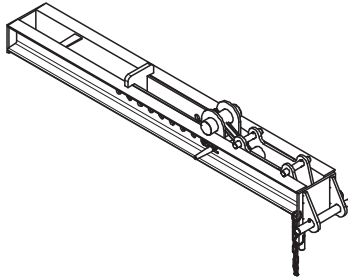

## Complete with

1 pc. 715585 Pin  $\varnothing$  25 x 240, SKS, galv.  
2 pc. 022230 Cotter Pin 5/1, galv.  
1 pc. 104031 Fitting Pin  $\varnothing$  21 x 120

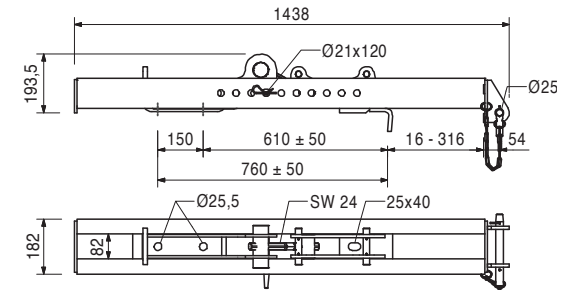

114113	2.030
--------	-------

## Cover RCS 70 x 70

Elastic covering for the area of the climbing shoe for use as climbing protection panel.

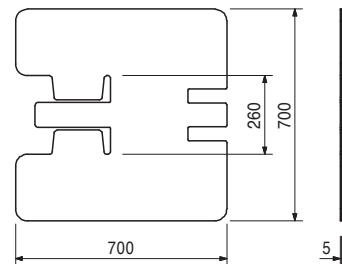
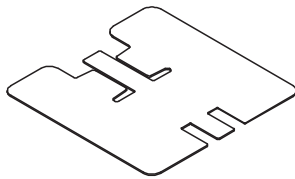

Item no.	Weight kg
114947	12.600

## Slab Anchor Template 61 RCS

For positioning the Advancing Bolt M24 for the Slab Shoe RCS. Fixed on the stopend formwork.

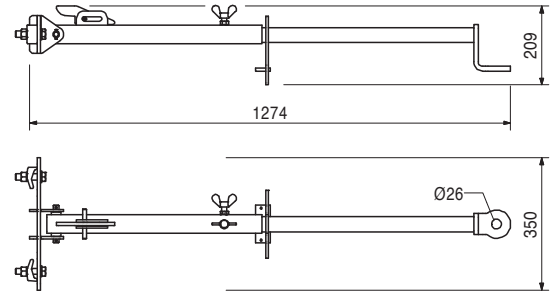
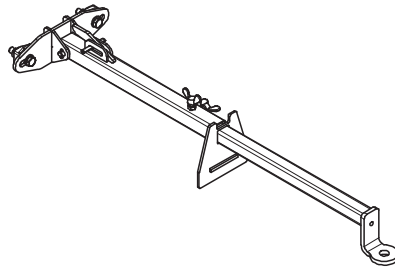

Accessories

029270	0.331
--------	-------

## Advancing Bolt M24, galv.

029270	0.331
--------	-------

## Advancing Bolt M24, galv.

For fixing the M24 anchor system if the plywood formlining is drilled through.

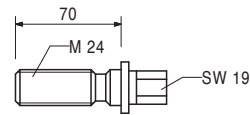
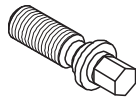

Accessories

029280	0.196
--------	-------

## Anchor Positioning Plate M24, galv.

115918	9.380
--------	-------

## Slab Shoe Adapter RCS/AV/SLS

Mounted on the Slab Shoe RCS and serves for connecting Kicker AV or SLS Spindles and Bracing DW 15.

## Complete with

- 2 pc. 104031 Fitting Pin Ø 21 x 120
- 2 pc. 027170 Pin Ø 16 x 42, galv.
- 4 pc. 018060 Cotter Pin 4/1, galv.

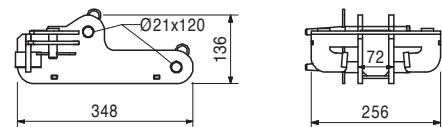
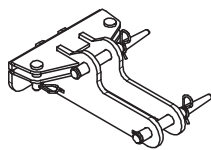

Item no.	Weight kg
115850	11.200

## Slab Support Adapter RCS

For attaching the Climbing Shoe RCS to a slab support with horizontal Climbing Rail RCS.

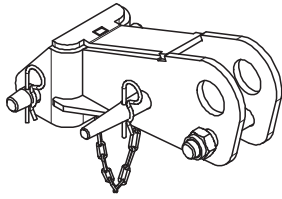

## Complete with

- 1 pc. 111567 Fitting Pin  $\varnothing$  26 x 120
- 1 pc. 715585 Pin  $\varnothing$  25 x 240, SKS, galv.
- 2 pc. 022230 Cotter Pin 5/1, galv.

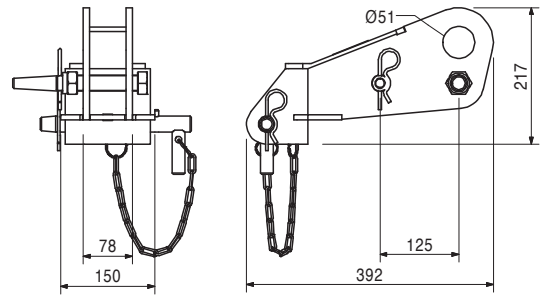

112359	15.000
--------	--------

## Slab Support Anchor Shoe RCS M24

Anchor System M24. For anchoring the slab support with horizontal Climbing Rail RCS.

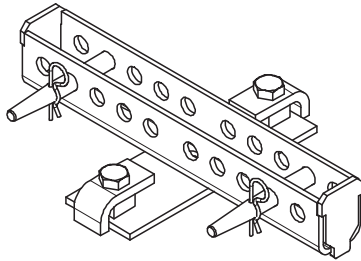

## Complete with

- 2 pc. 111567 Fitting Pin  $\varnothing$  26 x 120
- 2 pc. 022230 Cotter Pin 5/1, galv.
- 2 pc. 026290 Bolt ISO 4017 M24 x 50-10.9, galv.

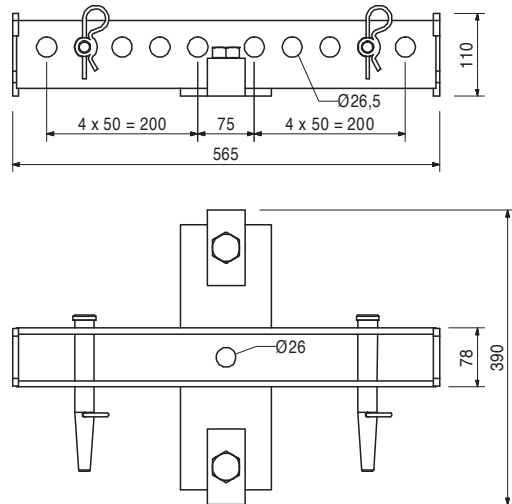

Accessories

026430	0.334
--------	-------

**Bolt ISO 4014 M24 x 70-10.9, galv.**

Item no.	Weight kg
116538	6.900

## Slab Support Alignment RCS

As compression point and for alignment of the slab support with horizontal Climbing Rail RCS. Fixation with the Anchor Bolt 14/20 x 130 or the anchor system M24.

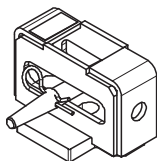

## Complete with

- 1 pc. 111567 Fitting Pin  $\varnothing$  26 x 120
- 1 pc. 022230 Cotter Pin 5/1, galv.

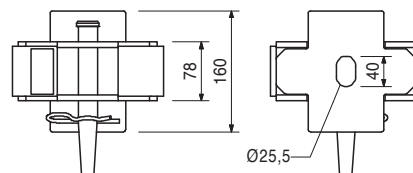
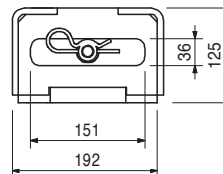

## Accessories

124777	0.210
--------	-------

## Anchor Bolt PERI 14/20 x 130

114158	1.030
--------	-------

## Screw-On Cone-2 M24/DW 20, galv.

Anchor system M24.  
For anchoring climbing systems.

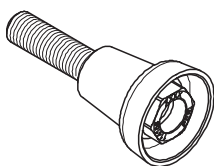

## Note

Separate design information on request.

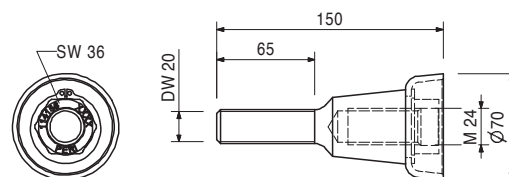

## Accessories

030860	0.792
--------	-------

## Threaded Anchor Plate DW 20

030860	0.792
--------	-------

## Threaded Anchor Plate DW 20

For use with Tie Rod DW 20, B 20 or Screw-On Cone-2 M24/DW 20. For anchoring in concrete.

## Note

Lost anchor part.

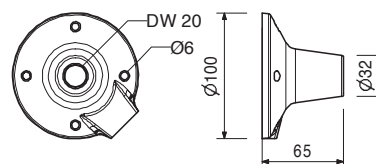
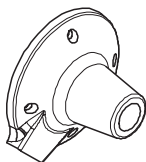



Item no.	Weight kg
031220	1.010

**Climbing Cone-2 M24/DW 15, galv.**  
Anchor system M24.  
For anchoring climbing systems.

**Note**  
Seperate design information on request.

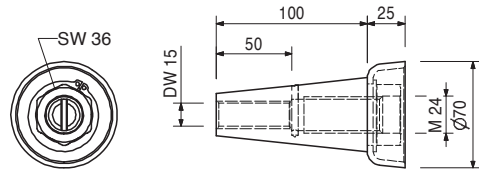
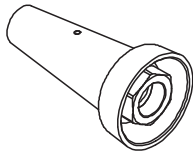

Accessories

030840	0.515
030030	1.440
030740	1.550

**Threaded Anchor Plate DW 15**  
**Tie Rod DW 15, spec. length**  
**Tie Rod B 15, spec. length**

030840	0.515
--------	-------

**Threaded Anchor Plate DW 15**  
For use with Tie Rod DW 15 or B 15. For anchoring in concrete.

**Note**  
Lost anchor part.

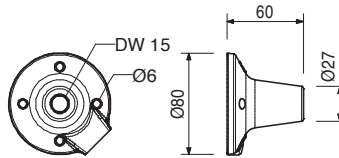
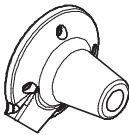

030030	1.440
030050	0.000

**Tie Rod DW 15**  
**Tie Rod DW 15, spec. length**  
**Cutting Cost Tie Rod DW 15, B 15**

**Note**  
Non-weldable! Take official approval into consideration!

**Technical Data**  
Permissible tension force 90 kN.

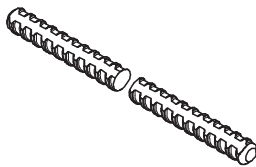

030740	1.550
030050	0.000

**Tie Rod B 15**  
**Tie Rod B 15, spec. length**  
**Cutting Cost Tie Rod DW 15, B 15**

**Note**  
Weldable! Take official approval into consideration!

**Technical Data**  
Permissible tension force 82 kN.

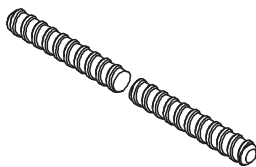

Item no.	Weight kg
026430	0.334

**Bolt ISO 4014 M24 x 70-10.9, galv.**  
High-strength bolt for anchoring climbing systems.

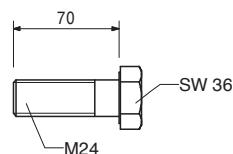
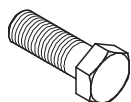

113232	10.500
--------	--------

**Slab Stopped Shoe RCS**  
For anchoring the Climbing Shoe RCS at the front end of the slab. Anchor System M30. With the Reduction Bush  $\varnothing$  30 – 25, Item no. 113822, also usable with Anchor System M24.

**Complete with**  
1 pc. 113247 Pin  $\varnothing$  25 x 260, mont.  
1 pc. 022230 Cotter Pin 5/1, galv.

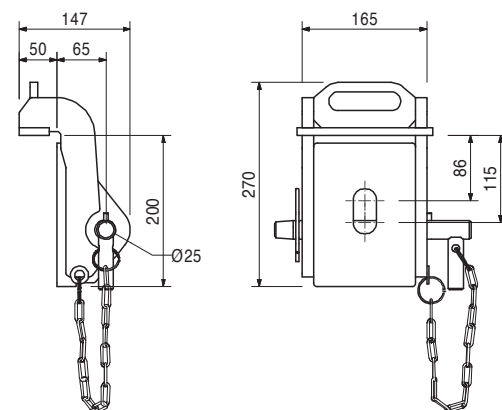
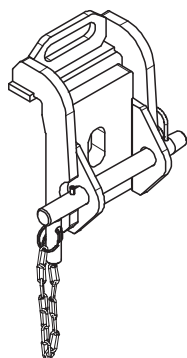

Accessories

029420	0.590
--------	-------

**Bolt ISO 4017 M30 x 70-8.8, galv.**

113822	0.108
--------	-------

**Reducing Bush  $\varnothing$  30 – 25**  
For using Stopped Slab Anchor M24/20-128 on the Stopped Slab Shoe RCS.

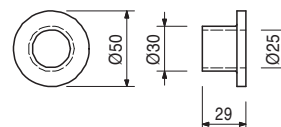

Accessories

026430	0.334
--------	-------

**Bolt ISO 4014 M24 x 70-10.9, galv.**

Item no.	Weight kg
113820	3.450
113821	6.700

**Stopend Slab Anchors**  
**Stopend Slab Anchor M24/20-128**  
**Stopend Slab Anchor M30/25-160**

Anchor System M24 or M30 for transferring clear tension forces into the slab with the use of Front Slab Shoe RCS.  
 With Positioning Plate M24 (grey) and M30 (red).

**Note**  
 Separate design information on request.

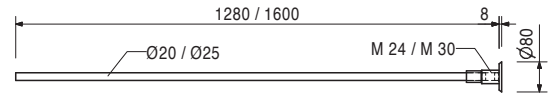
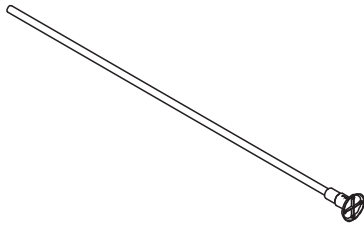

114997	7.160
--------	-------

**Bracing Shoe RCS DW 15**  
 For anchoring the bracing with DW 15 to the building slab. Fixation with Anchor System M24 or corresponding dowels.

**Complete with**  
 1 pc. 104031 Fitting Pin Ø 21 x 120  
 1 pc. 018060 Cotter Pin 4/1, galv.

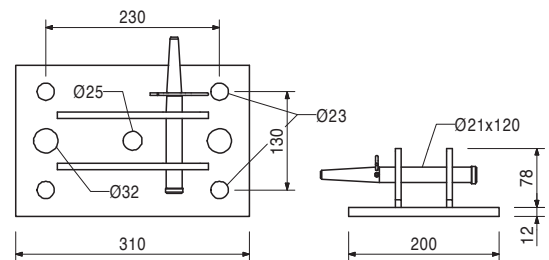
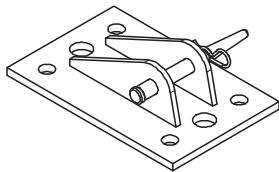

115375	6.100
--------	-------

**Articulated Spanner RCS DW 15**  
 For tensioning and as an articulated connection to the Climbing Rail RCS, Steel Waler SRU or Bracing Shoe RCS for bracing with DW 15.

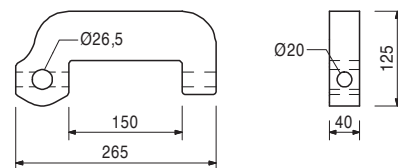
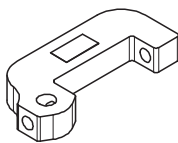

**Accessories**

104031	0.462
018060	0.030
111567	0.729
022230	0.033
030070	0.222

**Fitting Pin Ø 21 x 120**  
**Cotter Pin 4/1, galv.**  
**Fitting Pin Ø 26 x 120**  
**Cotter Pin 5/1, galv.**  
**Hex. Nut DW 15 SW 30/50, galv.**

Item no.	Weight kg
115378	1.080

## Eye Nut RCS DW 15

As an articulated connection to the Climbing Rail RCS, Steel Waler SRU for bracing with DW 15.

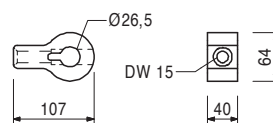

### Accessories

104031	0.462	<b>Fitting Pin Ø 21 x 120</b>
018060	0.030	<b>Cotter Pin 4/1, galv.</b>
111567	0.729	<b>Fitting Pin Ø 26 x 120</b>
022230	0.033	<b>Cotter Pin 5/1, galv.</b>

115388	1.910
--------	-------

## Forkhead Adapter RCS/SLS

For horizontal bracing of the climbing protection panel against the Slab Stopend Shoe RCS with a Heavy Duty Spindle SLS.

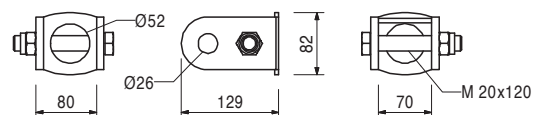

115298	4.210
--------	-------

## Spindle Shoe SLS/RCS M24

For horizontal bracing of the climbing protection panel against the Advancing Anchor M24 with a Heavy Duty Spindle SLS.

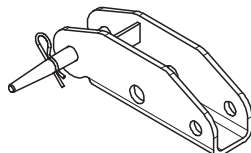

### Complete with

1 pc. 104031 Fitting Pin Ø 21 x 120  
1 pc. 018060 Cotter Pin 4/1, galv.

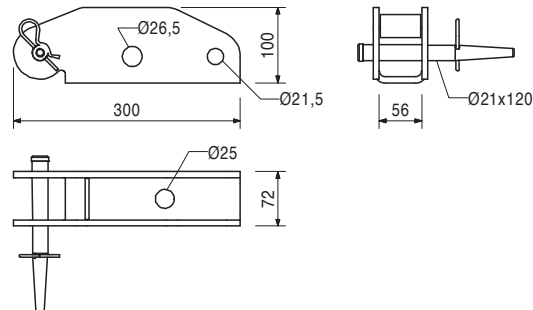

### Accessories

104031	0.462	<b>Fitting Pin Ø 21 x 120</b>
111567	0.729	<b>Fitting Pin Ø 26 x 120</b>



Item no.	Weight kg
109765	27.000

**Climbing Device RCS 50**  
 For crane-independent climbing of RCS Climbing Units.

**Note**  
 Follow Instructions for Use!  
**Technical Data**  
 Maximum lifting capacity 50 kN.

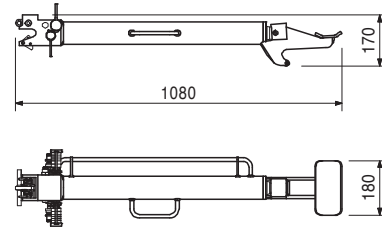
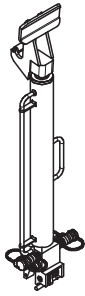

109766	109.000
--------	---------

**Hydraulic Pump RCS 4-fold, 380 – 460 V**  
 Hydraulic pump for actuating the Climbing Device RCS 50 and LPS 30.

**Note**  
 Follow Instructions for Use.  
 Use only original PERI hydraulic oil HV LP46.

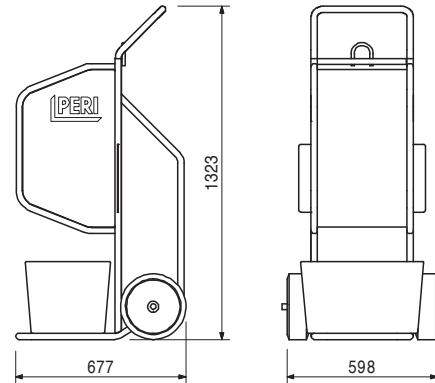
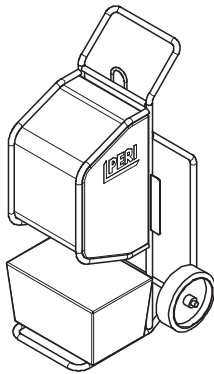

Accessories

057376	17.400
--------	--------

**Hydraulic Fluid HV LP46, 20 l**

057376	17.400
--------	--------

**Hydraulic Fluid HV LP46, 20 l**  
 High-grade, synthetic hydraulic oil for PERI Hydraulic Pump.

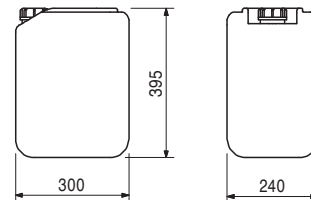

Item no.	Weight kg
110069	8.500
110070	15.300

**Hydraulic Twin Hoses RCS**  
**Hydraulic Twin Hose RCS, 10 m**  
**Hydraulic Twin Hose RCS, 20 m**

For connecting Hydraulic Pump RCS with the Climbing Device RCS 50. With quick-release connectors.

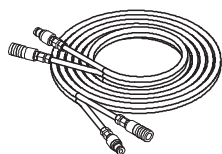

**Complete with**

2 pc. 110822 Quick Coupler Bushing RCS  
 2 pc. 110823 Quick Coupler Nipple RCS

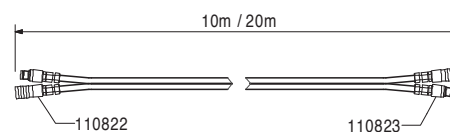

110280	0.500
--------	-------

**Adapter Cable RCS**

For the power supply to the Hydraulic Pump RCS.

**Note**

Follow Instructions for Use!  
 With CEE plug connector 400 V 16 A.

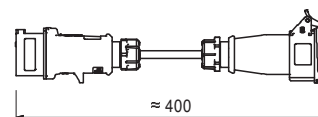
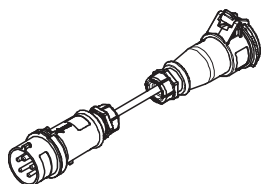

110279	0.250
--------	-------

**Plug Socket RCS, black**

For providing the power supply to the Hydraulic Pump RCS with 380 – 460 V, 50 – 60 Hz.

**Note**

Follow Instructions for Use!

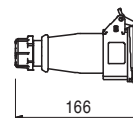

072180	0.560
051764	2.650
029610	5.300

**Ratchet Wrenchs**

**Ratchet Wrench 1/2"**  
**Ratchet Wrench 3/4"**  
**Ratchet Wrench 1"**

**L**

300  
 630  
 900

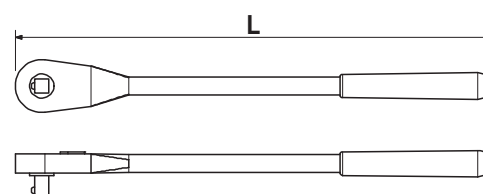
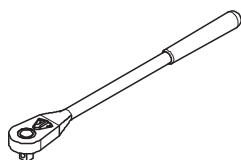

Item no.	Weight kg
----------	-----------

029620	0.075
057276	0.625
102785	0.452
029630	0.580

### Sockets

**Socket SW 19-1/2"**

**Socket SW 30-3/4"**

**Socket SW 36-3/4"**

**Socket SW 46-1"**

Fits to Hex. Bolts M12 or Height Adjusting Unit SW 19.



110094	0.895
--------	-------

### Carriage Crank Lever SW 19

For operating the Carriage RCS.

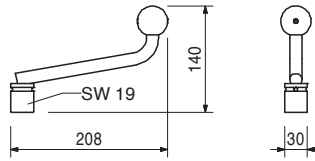
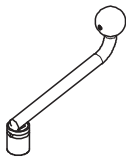

110950	4.760
--------	-------

### Excentric Lever RCS

For dismantling Climbing Shoe RCS.

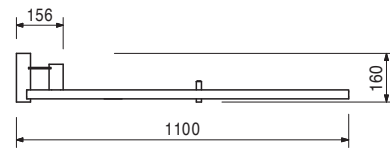
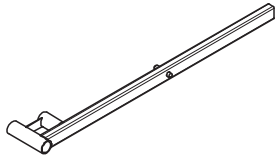





# PERI International

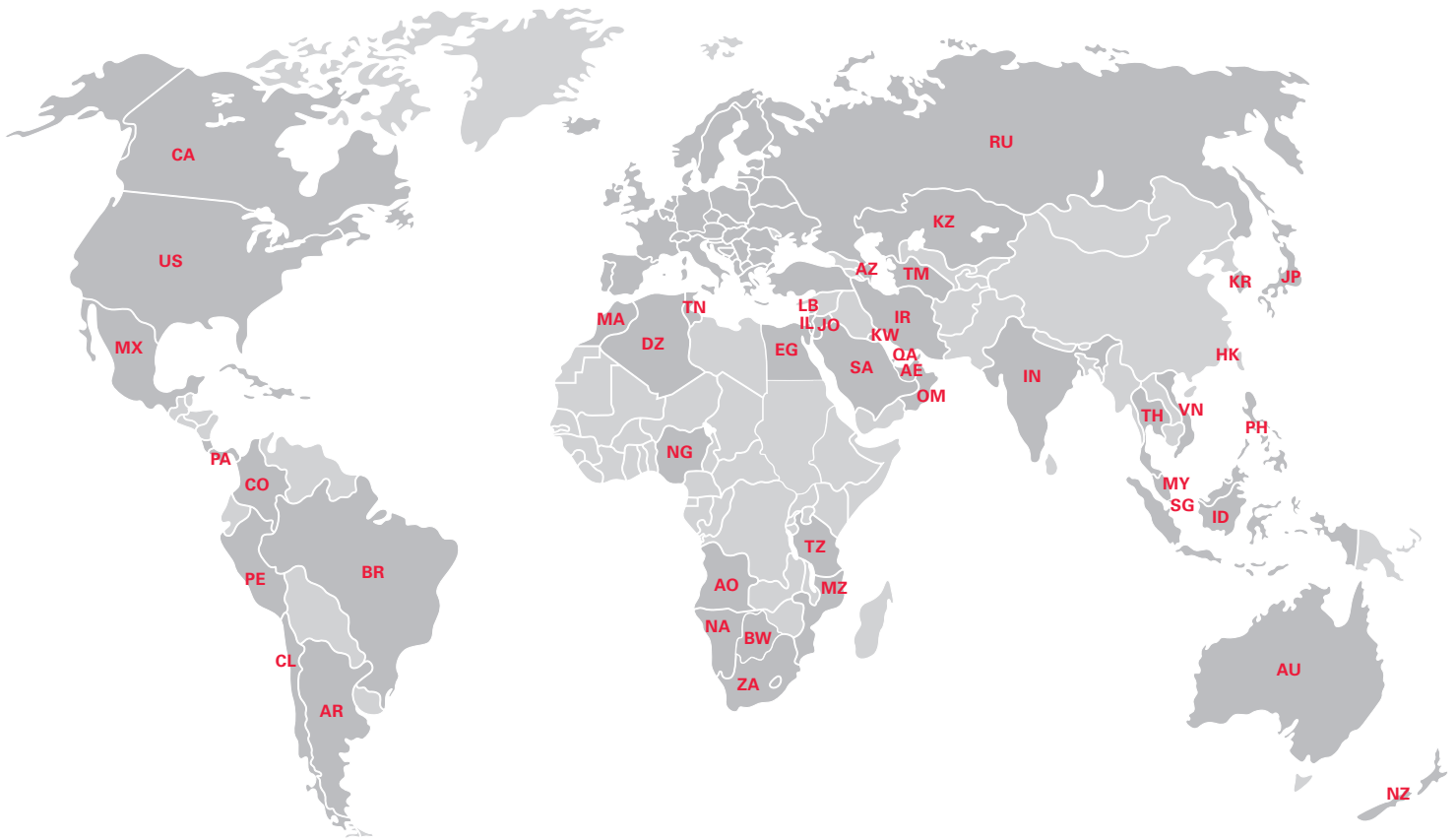

## North America

- CA** Canada  
PERI Formwork Systems, Inc.  
[www.peri.ca](http://www.peri.ca)
- MX** Mexico  
PERI Cimbras y Andamios, S.A. de C.V.  
[www.peri.com.mx](http://www.peri.com.mx)
- PA** Panama  
PERI Panama Inc.  
[www.peri.com.pa](http://www.peri.com.pa)
- US** USA  
PERI Formwork Systems, Inc.  
[www.peri-usa.com](http://www.peri-usa.com)

## South America

- AR** Argentina  
PERI S.A.  
[www.peri.com.ar](http://www.peri.com.ar)
- BR** Brazil  
PERI Formas e Escoramentos Ltda.  
[www.peribrasil.com.br](http://www.peribrasil.com.br)
- CL** Chile  
PERI Chile Ltda.  
[www.peri.cl](http://www.peri.cl)
- CO** Colombia  
PERI S.A.S.  
[www.peri.com.co](http://www.peri.com.co)
- PE** Peru  
PERI Peruana S.A.C.  
[www.peri.com.pe](http://www.peri.com.pe)

## Africa

- AO** Angola  
Pericofragens, Lda.  
[www.peri.pt](http://www.peri.pt)
- DZ** Algeria  
S.A.R.L. PERI  
[www.peri.dz](http://www.peri.dz)
- BW** Botswana  
PERI (Proprietary) Limited  
[www.peri.co.bw](http://www.peri.co.bw)
- EG** Egypt  
Egypt Branch Office  
[www.peri.com.eg](http://www.peri.com.eg)
- MA** Morocco  
PERI S.A.  
[www.peri.ma](http://www.peri.ma)
- MZ** Mozambique  
PERI (Pty.) Ltd.  
[www.peri.co.mz](http://www.peri.co.mz)
- NA** Namibia  
PERI (Pty.) Ltd.  
[www.peri.na](http://www.peri.na)
- NG** Nigeria  
PERI Nigeria Ltd.  
[www.peri.ng](http://www.peri.ng)
- TN** Tunisia  
PERI S.A.U.  
[www.peri.es](http://www.peri.es)
- TZ** Tanzania  
PERI Formwork and Scaffolding Ltd  
[www.peritanzania.com](http://www.peritanzania.com)
- ZA** South Africa  
PERI Formwork Scaffolding (Pty) Ltd  
[www.peri.co.za](http://www.peri.co.za)

## Asia

- AE** United Arab Emirates  
PERI (L.L.C.)  
[www.perime.com](http://www.perime.com)
- AZ** Azerbaijan  
PERI Representative Office  
[www.peri.com.tr](http://www.peri.com.tr)
- HK** Hong Kong  
PERI (Hong Kong) Limited  
[www.perihk.com](http://www.perihk.com)
- ID** Indonesia  
PT Beton Perkasa Wijaksana  
[www.betonperkasa.com](http://www.betonperkasa.com)
- IL** Israel  
PERI F.E. Ltd.  
[www.peri.co.il](http://www.peri.co.il)
- IN** India  
PERI (India) Pvt Ltd  
[www.peri.in](http://www.peri.in)
- IR** Iran  
PERI Pars. Ltd.  
[www.peri.ir](http://www.peri.ir)
- JO** Jordan  
PERI GmbH – Jordan  
[www.peri.com](http://www.peri.com)
- JP** Japan  
PERI Japan K.K.  
[www.perijapan.jp](http://www.perijapan.jp)
- KR** Korea  
PERI (Korea) Ltd.  
[www.perikorea.com](http://www.perikorea.com)
- KW** Kuwait  
PERI Kuwait W.L.L.  
[www.peri.com.kw](http://www.peri.com.kw)
- KZ** Kazakhstan  
TOO PERI Kazakhstan  
[www.peri.kz](http://www.peri.kz)
- LB** Lebanon  
PERI Lebanon Sarl  
[lebanon@peri.de](mailto:lebanon@peri.de)
- MY** Malaysia  
PERI Formwork Malaysia Sdn. Bhd.  
[www.perimalaysia.com](http://www.perimalaysia.com)
- OM** Oman  
PERI (L.L.C.)  
[www.perime.com](http://www.perime.com)
- PH** Philippines  
PERI-Asia Philippines, INC.  
[www.peri.com.ph](http://www.peri.com.ph)
- QA** Qatar  
PERI Qatar LLC  
[www.peri.qa](http://www.peri.qa)
- SA** Saudi Arabia  
PERI Saudi Arabia Ltd.  
[www.peri.com.sa](http://www.peri.com.sa)
- SG** Singapore  
PERI Asia Pte Ltd  
[www.periasia.com](http://www.periasia.com)
- TM** Turkmenistan  
PERI Kalıp ve İşkeleleri  
[www.peri.com.tr](http://www.peri.com.tr)
- TH** Thailand  
Peri (Thailand) Co., Ltd.  
[www.peri.co.th](http://www.peri.co.th)
- VN** Vietnam  
PERI ASIA PTE LTD  
[www.peri.com.vn](http://www.peri.com.vn)

**PERI**

**PERI GmbH**  
**Formwork Scaffolding Engineering**  
 Rudolf-Diesel-Strasse 19  
 89264 Weissenhorn  
 Germany  
 Tel. +49 (0)7309.950-0  
 Fax +49 (0)7309.951-0  
 info@peri.com  
 www.peri.com



## Oceania

**AU** Australia  
 PERI Australia Pty. Ltd.  
 www.periaus.com.au

**NZ** New Zealand  
 PERI Australia Pty. Limited  
 www.peri.co.nz

## Europe

**AL** Albania  
 PERI Kalıp ve İskeleleri  
 www.peri.com.tr

**AT** Austria  
 PERI Ges.mbh  
 www.peri.at

**BA** Bosnia and Herzegovina  
 PERI oplate i skele d.o.o  
 www.peri.com.hr

**BE** Belgium  
 N.V. PERI S.A.  
 www.peri.be

**BG** Bulgaria  
 PERI Bulgaria EOOD  
 www.peri.bg

**BY** Belorussia  
 IOOO PERI  
 www.peri.by

**CH** Switzerland  
 PERI AG  
 www.peri.ch

**CZ** Czech Republic  
 PERI spol. s r.o.  
 www.peri.cz

**DE** Germany  
 PERI GmbH  
 www.peri.de

**DK** Denmark  
 PERI Danmark A/S  
 www.peri.dk

**EE** Estonia  
 PERI AS  
 www.peri.ee

**ES** Spain  
 PERI S.A.U.  
 www.peri.es

**FI** Finland  
 PERI Suomi Ltd. Oy  
 www.perisuomi.fi

**FR** France  
 PERI S.A.S.  
 www.peri.fr

**GB** United Kingdom  
 PERI Ltd.  
 www.peri.ltd.uk

**GR** Greece  
 PERI Hellas Ltd.  
 www.perihellas.gr

**HR** Croatia  
 PERI oplate i skele d.o.o.  
 www.peri.com.hr

**HU** Hungary  
 PERI Kft.  
 www.peri.hu

**IR** Ireland  
 Siteserv Access & Formwork  
 www.siteservaccess.ie

**IS** Iceland  
 Armar ehf.  
 www.armor.is

**IT** Italy  
 PERI S.r.l.  
 www.peri.it

**LT** Lithuania  
 PERI UAB  
 www.peri.lt

**LU** Luxembourg  
 N.V. PERI S.A.  
 www.peri.lu

**LV** Latvia  
 PERI SIA  
 www.peri-latvija.lv

**NL** Netherlands  
 PERI B.V.  
 www.peri.nl

**NO** Norway  
 PERI Norge AS  
 www.peri.no

**PL** Poland  
 PERI Polska Sp. z o.o.  
 www.peri.com.pl

**PT** Portugal  
 Pericofragens Lda.  
 www.peri.pt

**RO** Romania  
 PERI România SRL  
 www.peri.ro

**RS** Serbia  
 PERI oplate d.o.o.  
 www.peri.rs

**RU** Russia  
 OOO PERI  
 www.peri.ru

**SE** Sweden  
 PERI Sverige AB  
 www.peri.se

**SI** Slovenia  
 PERI oplate i skele d.o.o  
 www.peri.com.hr

**SK** Slovakia  
 PERI spol. s. r.o.  
 www.peri.sk

**TR** Turkey  
 PERI Kalıp ve İskeleleri  
 www.peri.com.tr

**UA** Ukraine  
 TOW PERI  
 www.peri.ua

**The optimal System  
for every Project and  
every Requirement**



**Wall Formwork**



**Column Formwork**



**Slab Formwork**



**Climbing Systems**



**Bridge Formwork**



**Tunnel Formwork**



**Shoring Systems**



**Construction Scaffold**



**Facade Scaffold**



**Industrial Scaffold**



**Access**



**Protection Scaffold**



**Safety Systems**



**System-Independent Accessories**



**Services**



**PERI GmbH**  
**Formwork Scaffolding Engineering**  
 Rudolf-Diesel-Strasse 19  
 89264 Weissenhorn  
 Germany  
 Tel. +49 (0)7309.950-0  
 Fax +49 (0)7309.951-0  
 info@peri.com  
 www.peri.com