

PERI Bérlet kritériumok

RAPID Pillérzsaluzat



Kapcsolat

PERI Kft,
Zsaluzatok, állványzatok,
mérnöki szolgáltatás

H-1181 Budapest
Zádor u. 9.
Tel.:+36-1-296-09-60
www.peri.hu

Tartalom	Oldal
Rapid pillér keretváz	2
Betonozó állvány	5
Betonozó podesz daruemelő	9
Daru felfüggesztés RAPID	12
Tartó csatlakozó RAPID	13
Létra 180/6	14
Létra korlát	15
Létra csatlakozó RAPID	16
Magyarázat	17

Változtatások	Dátum ü	Oldal
Új verzió	11/2015 SZ.L.	
Számos kép cserélve	05/2018 fw	

PERI Bérleti kritériumok

RAPID Pillérzsaluzat



RAPID pillér keretváz

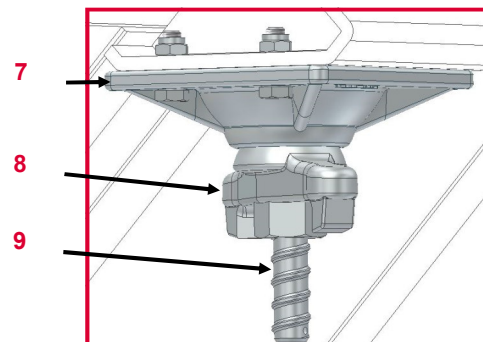
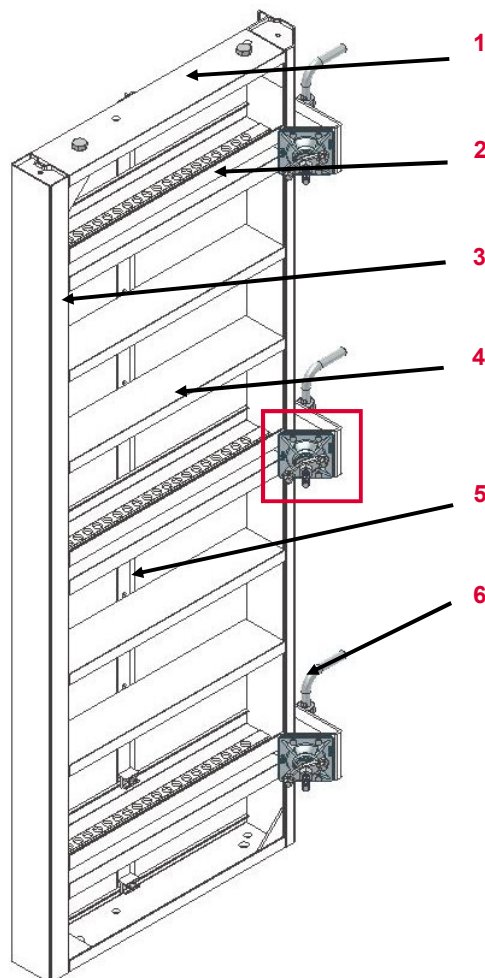











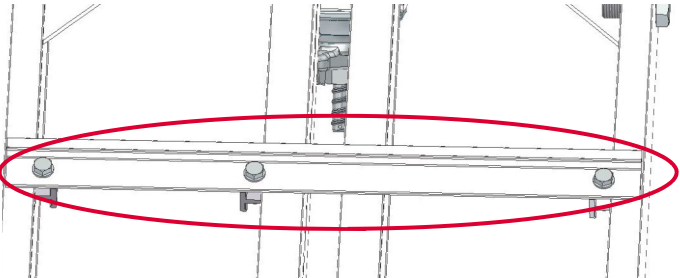









Sorszám	Megnevezés	Cikkszám
1	Végzáró profil	
2	Feszítősín	
3	Oldalprofil	
4	Merevítő borda	
5	Rögzítő profil	
6	Rapid Bizt. dugasz	037160
7	Alaplemez	780360
8	Rapid szárnyasanya	030440
9	Rapid átkötőrúd DW15	037150

Megnevezés	Cikkszám
Pillér keretváz RAPID 300 Alu	037250
Pillér keretváz RAPID 210 Alu	037260
Pillér keretváz RAPID 60 Alu	037270

PERI Bérleti kritériumok

RAPID Pillérzsaluzat



Rapid pillér keretváz	Leírás	Instrukció	Fizetési kondíció	Típus
	17.10.01 Rögzítő profil <ul style="list-style-type: none"> ■ Deformálódott 		 088244	
	<ul style="list-style-type: none"> ■ Vagy hiányzik 		Rögzítő profil 300 (786105) Rögzítő profil 210 (786104) Rögzítő profil 60 (786103)	 088836 088835 088834
	17.10.02 Zsaluhéj tartó profil <ul style="list-style-type: none"> ■ Deformálódott 		 088244	
	<ul style="list-style-type: none"> ■ Repedés szakadás 		 088273	
	17.10.03 Lyuk, repedés a profilban <ul style="list-style-type: none"> ■ ≤ 30 mm 		 088273	
	<ul style="list-style-type: none"> ■ Vagy > 30 mm 			

PERI Bérleti kritériumok

RAPID Pillérzsaluzat



Rapid pillér keretváz	Leírás	Instrukció	Fizetési kondíció	Típus
	17.10.04 Merevítő borda deformálódása			
	<ul style="list-style-type: none"> ■ Ha lehetséges 		 088244	
	<ul style="list-style-type: none"> ■ Vagy ha nem lehetséges 			
	17.10.05 Feszítősín görbült, törött			
	<ul style="list-style-type: none"> ■ Ha lehetséges 		 088244	
	<ul style="list-style-type: none"> ■ Vagy ha nem lehetséges 			
	17.10.06 Görbült Pillér keretváz			
	<ul style="list-style-type: none"> ■ > 6mm 			

PERI Bérleti kritériumok

RAPID Pillérzsaluzat



TRS, QUATRO betonozó állvány (037400)

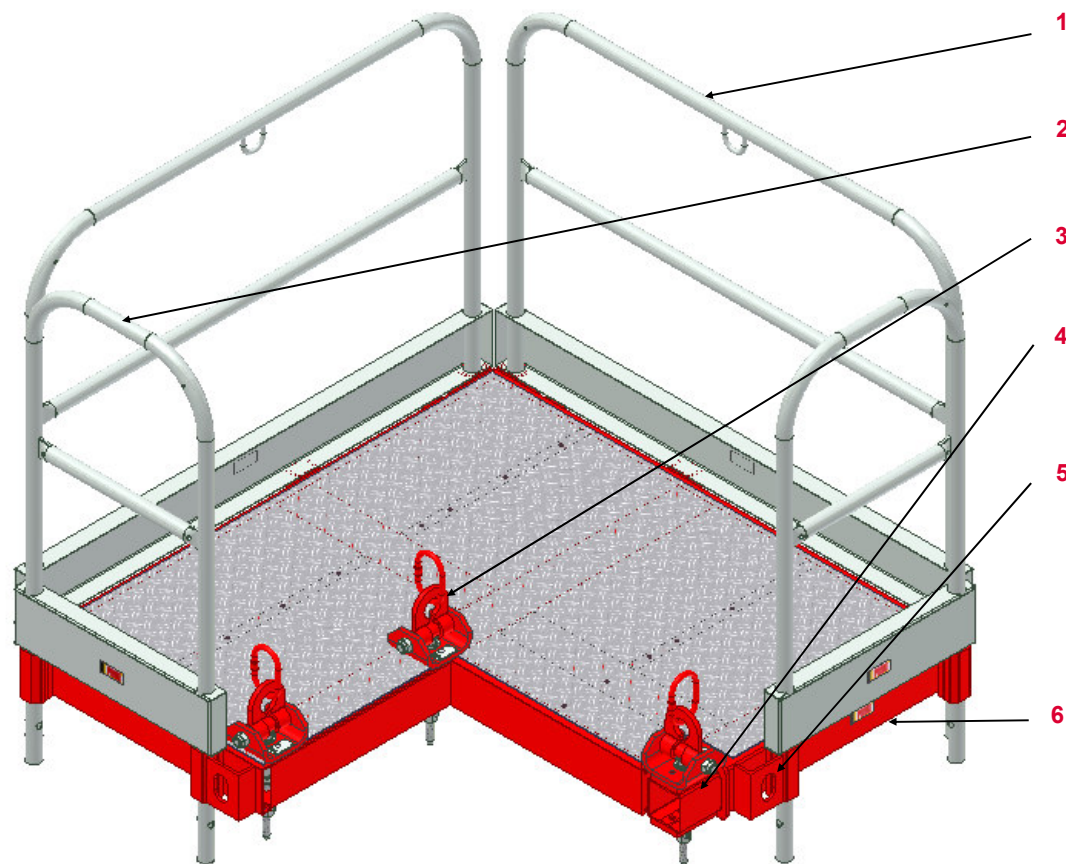















Sorszám	Megnevezés	Cikkszám
1	Betonozó pod. védőkoriát 134	037430
2	Betonozó podesz védőkoriát 52	037420
3	Betonozó pod. daruemelő	037440
4	Teleszkóp cső	786108
5	Korlátoszlop tartó	
6	Rapid betonozó állvány	037410

PERI Bérleti kritériumok

RAPID Pillérzsaluzat











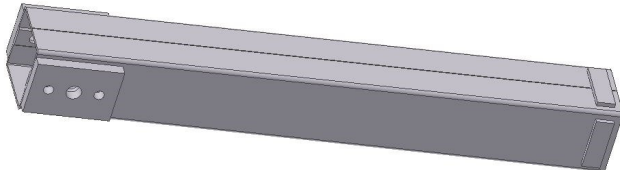

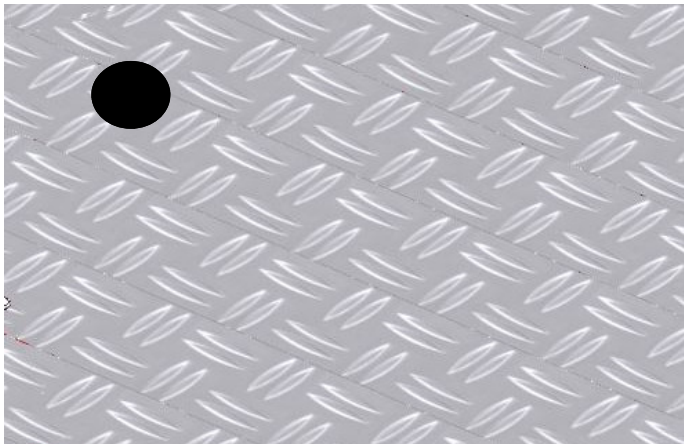

TRS, QUATRO betonozó állvány	Leírás	Instrukció	Fizetési kondíció	Típus
	17.10.07 Korlát 134 <ul style="list-style-type: none"> ■ Repedés a hegesztésben 	 Korlát 134 (037430)	 088590	
	<ul style="list-style-type: none"> ■ Vagy deformálódott 	 Korlát 134 (037430)	 088590	
	17.10.08 Korlát 52 <ul style="list-style-type: none"> ■ Repedés a hegesztésben 	 Korlát 52 (037420)	 088589	
	<ul style="list-style-type: none"> ■ Vagy deformálódott 	 Korlát (037420)	 088589	

PERI Bérleti kritériumok

RAPID Pillérzsaluzat

















Betonozó állvány	Leírás	Instrukció	Fizetési kondíció	Típus
	17.10.09 Teleszkóp cső <ul style="list-style-type: none"> ■ Elgöbült 	 Teleszkóp cső(786108)	 088582	
	<ul style="list-style-type: none"> ■ Vagy furatok kitágultak 	 Teleszkóp cső (786108)		
	17.10.10 Lyukak a felületen <ul style="list-style-type: none"> ■ ≤ 30 mm 			
	<ul style="list-style-type: none"> ■ > 30 mm 			

PERI Bérleti kritériumok

RAPID Pillérzsaluzat



Sérülés a betonozó állványon	Leírás	Instrukció	Fizetési kondíció	Típus
	17.10.11 Korlátozlop tartó nagy <ul style="list-style-type: none"> ■ Anyag vagy hegesztés repedése nélküli deformáció 		 088244	
	<ul style="list-style-type: none"> ■ Anyag vagy hegesztés repedt 			
	17.10.12 Korlátozlop tartó kicsi <ul style="list-style-type: none"> ■ Anyag vagy hegesztés repedése nélküli deformáció 		 088244	
	<ul style="list-style-type: none"> ■ Anyag vagy hegesztés repedt 			

PERI Bérleti kritériumok

RAPID Pillérzsaluzat



Betonozó podesz daruemelő (037440)

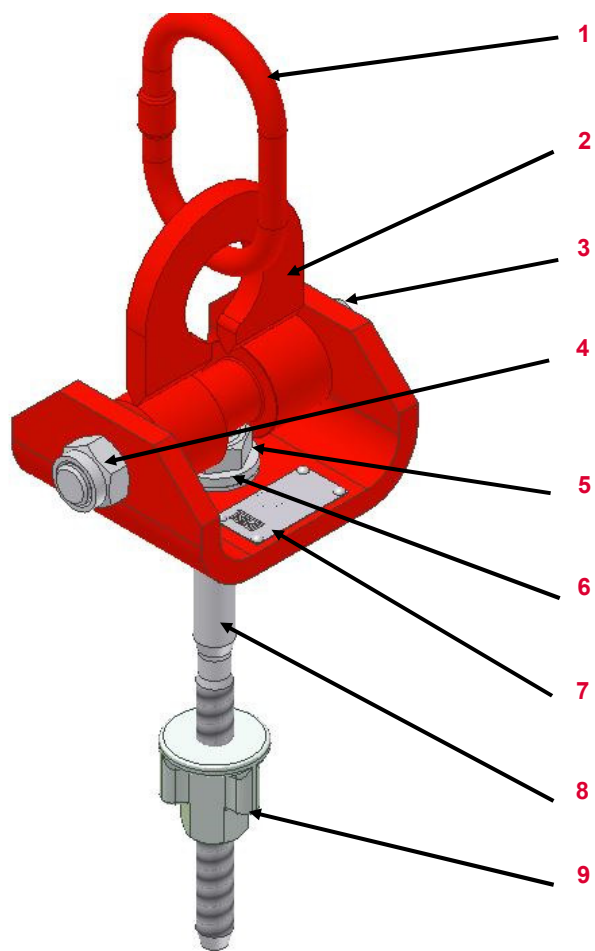















Sorszám	Megnevezés	Cikkszám
---------	------------	----------

1	Daru felfüggesztés	
2	Daru szem	
3	Csavar	781054
4	Csavaranya	781053
5	Csavaralátét	105513
6	Rugós alátét	781016
7	Típustábla	710539
8	TRS átkötő csavar	054230
9	Bütykös anya	030130

PERI Bérleti kritériumok

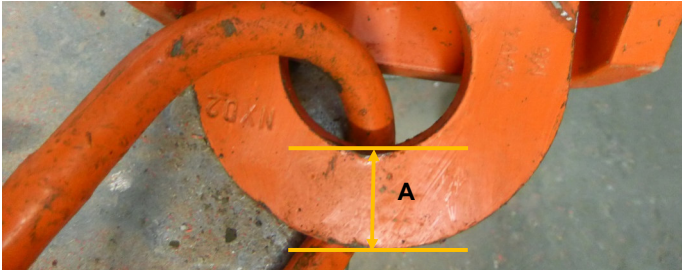
RAPID Pillérzsaluzat



Daruemelő	Leírás	Instrukció	Fizetési kondíció	Típus
	17.10.13 Elveszett, olvashatatlan típus tábla	 Típus tábla (710539)  Szegecs (767043)		
	17.10.14 Függesztő tartó <ul style="list-style-type: none"> ■ $\varnothing \leq 12,5 \text{ mm}$ 	 		
	17.10.15 Daru felfüggesztés <ul style="list-style-type: none"> ■ $A \leq 22,5 \text{ mm}$ 	 		

PERI Bérleti kritériumok

RAPID Pillérzsaluzat













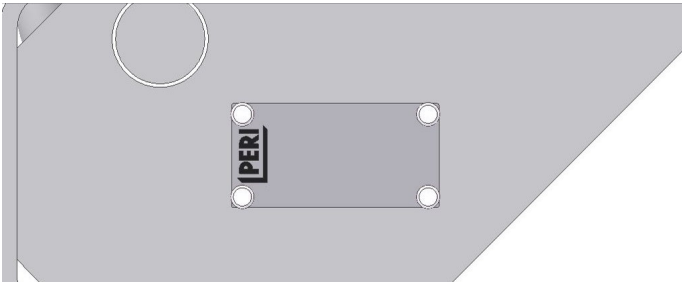

Daruemelő	Leírás	Instrukció	Fizetési kondíció	Típus
	17.10.16 Sérült bütykös anya	 Bütykös anya(030130)	 088429	
	17.10.17 A TRS csavar elgörbült, törött vagy vágott	 TRS átkötő csavar (054230)		
	17.10.18 A daru felfüggesztése nem mozog	 Használjon kenőanyagot		

PERI Bérleti kritériumok

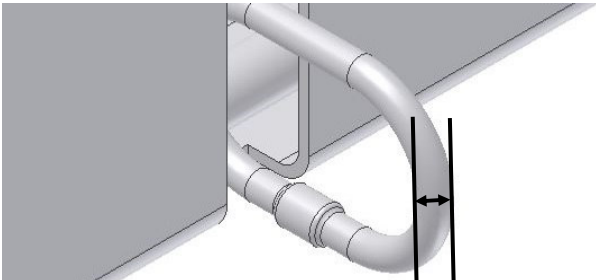
RAPID Pillérzsaluzat



RAPID daruemelő profil-2 (037320)	Leírás	Instrukció	Fizetési kondíció	Típus
	17.10.19 Meggömbült daruemelő profil		 088244	
	17.10.20 Elveszett, olvashatatlan típus tábla	 Típustábla (710538) Szegecs (710217)		
	17.10.21 Daru felfüggesztés ■ $\varnothing \leq 12,5$ mm	 		

PERI Bérleti kritériumok

RAPID Pillérzsaluzat



RAPID támaszkapcsoló-3 (037190)

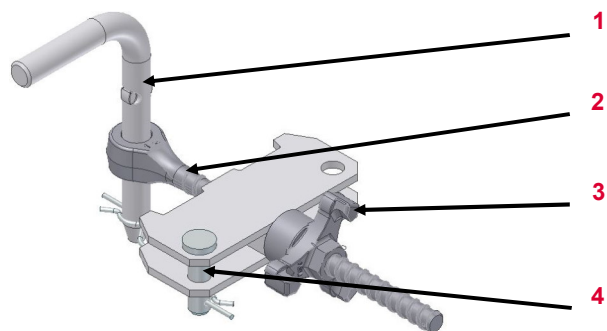

Sorszám	Megnevezés	Cikkszám
1	Rapid bizt. dugasz	037160
2	Rapid átkötőrúd	037150
3	Háromszárnyú anya	030190
4	Csap 16x42	027170

Sérülés

Leírás

Instrukció

Fizetési kondíció

Típus



17.10.22 Csatlakozó deformálódott



088244



17.10.23 Törött szárnyasanya



Háromszárnyú anya (030190)













088541

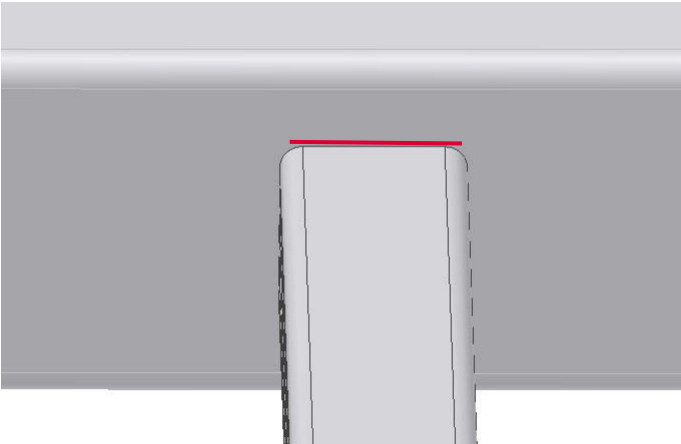

PERI Bérleti kritériumok

RAPID Pillérzsaluzat



Sérült létra180/6 (051410)	Leírás	Instrukció	Fizetési kondíció	Típus
	17.10.24 Létrafok deformálódott ■ > 3 mm			
	17.10.25 Hegesztés szakadt ■ Anyag deformálódása nélkül			
	■ Vagy deformációval			

PERI Bérleti kritériumok

RAPID Pillérzsaluzat



Sérült lépcsőkorlát (104132; 051450)	Leírás	Instrukció	Fizetési kondíció	Típus
--------------------------------------	--------	------------	-------------------	-------

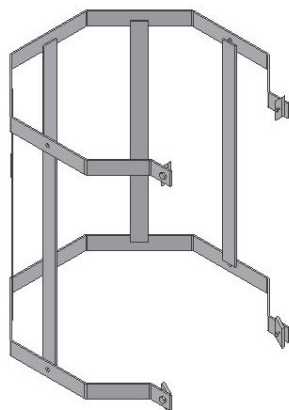

17.10.26 Deformálódott

- > 5 mm

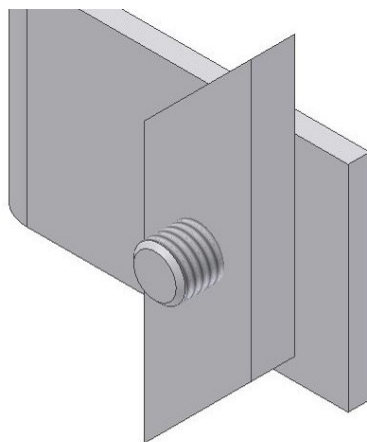

17.10.27 Rögzítőlemez törött vagy hiányzik



Rögzítőlemez (701763)
Csavar (710266)



088295



PERI Bérleti kritériumok

RAPID Pillérzsaluzat



Létracsatlakozó RAPID (103369)	Sorszám	Megnevezés	Cikkszám
--------------------------------	---------	------------	----------

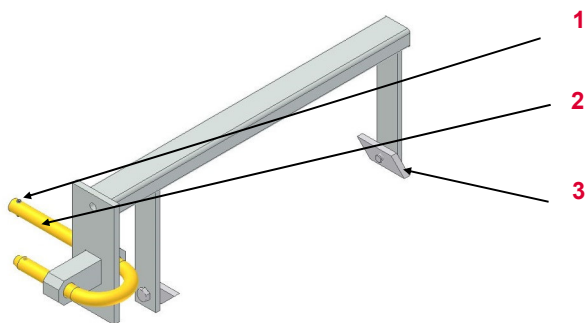

1	Hasított ék	710417
2	Biztonsági csap	104065
3	Rögzítő lemez	701763

Sérülés	Leírás	Instrukció	Fizetési kondíció	Típus
---------	--------	------------	-------------------	-------



17.10.28 Törött rögzítőlemez



Rögzítőlemez (710763)
Csavar (710266)



088295



17.10.29 Biztonsági csap törött vagy görbült



















Biztonsági konzol(104065)
Rögzítőkampó (710417)



PERI Bérleti kritériumok

Magyarázat



Ikon	Jelentés	Ikon	Jelentés	Ikon	Jelentés
	Nem OK — kicselezendő		Ügyfélnek leszámházandó		Optikai kár
	OK– marad a bérleti parkban		Nincs számlázás		Funkcionális sérülés
	Selejt anyag – biztonsági okokból az anyagot tilos kiadni		Anyagot levágni		Funkcionális sérülés — anyag kiadása nem engedélyezett
	Javítás az előírások szerint		Anyagot megjelölni		Statikai sérülés — anyag kiadása nem engedélyezett
	Hideg egyengetés — utána a varratokat és a környékét ellenőrzni kell		Sérült anyag cseréje		
	Javítás gazdaságosság függvényében		Hiányzó anyag pótlása		
	Megtisztítani az anyagot				