

# PERI Bérleti kritériumok

## Ipari állványok



### Kapcsolat

**PERI kft,**  
zsaluzatok, állványzatok,  
mérnöki szolgáltatás

H-1181 Budapest  
Zádor u. 9.  
Tel.: +36-1-296-09-60

Tartalom	oldal	Változtatások	Dátum   ü	oldal
Konzolok	2	Új verzió	08/2021   O.L.	
Védőkorlát	6			
UP Láblemez UPY	12			
UP Lábdeszka UPF	14			
UP Kibúvóelem   Fedőlemez	16			
Csatlakozó alkatrészek	19			
Futómacska UFS 20	24			
További Elemek	26			
Magyarázat	34			

# PERI Bérleti kritériumok

## Ipari állványok



### UP Konzol UCM | UP Konzol UC

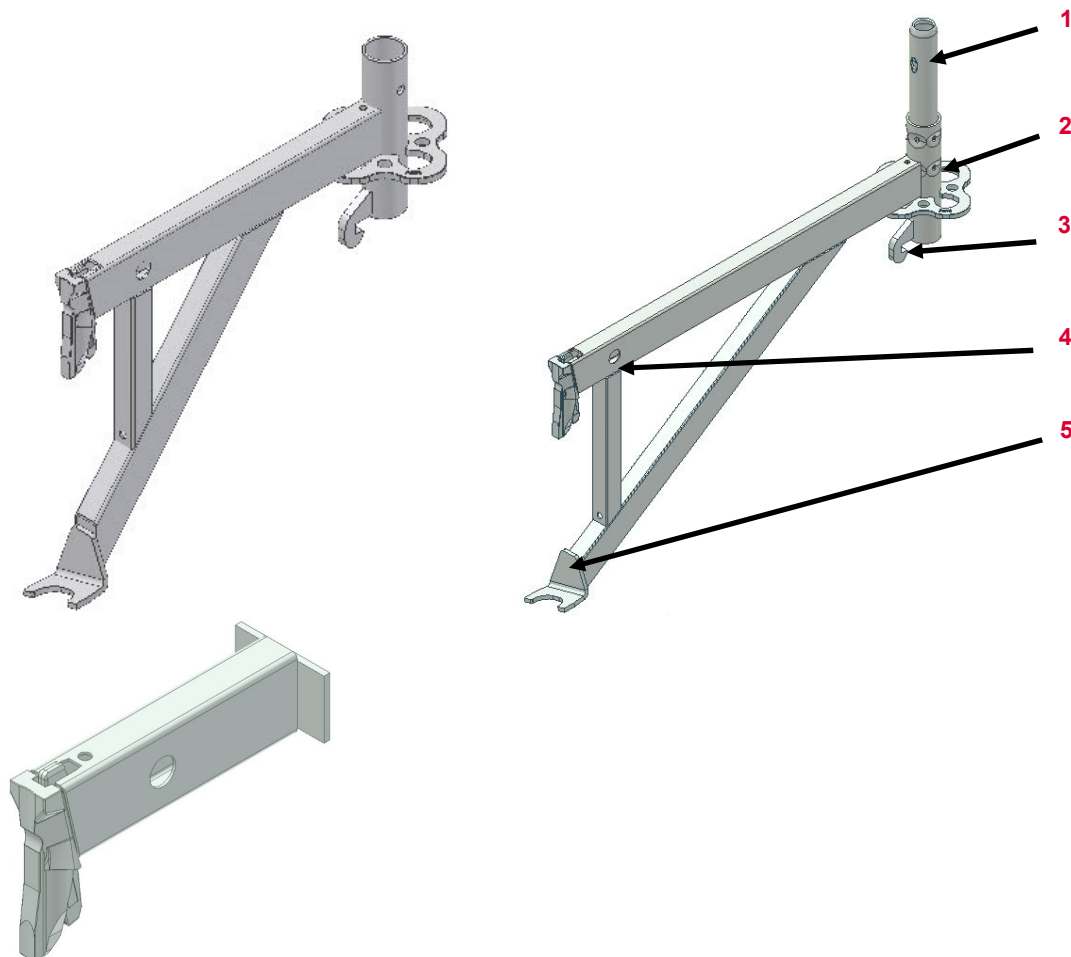





















Sorszám	Megnevezés	Cikkszám
1	Csap	
2	Rozetta	
3	Alsó biztosító	
4	Ék UCM	
5	Lemez UCM	

Megnevezés	Cikkszám
UP Konzol UCM 50-2	110483
UP Konzol UCM 75-2	111128
UP Konzol UCM 50	112676
UP Konzol UCM 75	112678
UP Konzol UCM 50 fél rozetta	112690
UP Konzol UCM 75 fél rozetta	112693
UP Konzol UC 25	115959
UP Konzol UC 33	130390
UP Konzol UC 37,5	115962

# PERI Bérleti kritériumok

## Ipari állványok













UP Konzol UCM	Leírás	Instrukció	Fizetési kondíciók	Típus
	<b>Alsó biztosító elgörbült</b>			
	<ul style="list-style-type: none"> <li>■ Ha lehetséges</li> </ul>		 088244	
	<ul style="list-style-type: none"> <li>■ Ha nem lehetséges</li> </ul>			
<ul style="list-style-type: none"> <li>■ Repedések a hegesztésben</li> </ul>				
	<b>UCM lemez elhajlott</b>			
	<ul style="list-style-type: none"> <li>■ Ha lehetséges (Csatlakozás lehetséges)</li> </ul>		 088244	
	<ul style="list-style-type: none"> <li>■ Ha nem lehetséges</li> </ul>			
<ul style="list-style-type: none"> <li>■ Repedések a hegesztésben</li> </ul>				

# PERI Bérleti kritériumok

## Ipari állványok



UP Konzol UCM	Leírás	Instrukció	Fizetési kondíciók	Típus
	<p>Rozetta   Fél-rozetta hajlott</p> <ul style="list-style-type: none"> <li>■ ≤ 20 mm</li> <li>■ Vagy &gt; 20 mm</li> </ul>	<ul style="list-style-type: none"> <li>  </li> <li>  </li> </ul>	<ul style="list-style-type: none"> <li>  088244         </li> <li>  </li> </ul>	<ul style="list-style-type: none"> <li>  </li> <li>  </li> </ul>
	<p>Ékház nyitott   Ék hiányzik</p>	<ul style="list-style-type: none"> <li>  </li> </ul>	<ul style="list-style-type: none"> <li>  </li> </ul>	<ul style="list-style-type: none"> <li>  </li> </ul>

# PERI Bérleti kritériumok

## Ipari állványok

















UP Konzol UCM	Leírás	Instrukció	Fizetési kondíciók	Típus
	<b>Perem horpadt</b>		088244	
	■ Ha lehetséges			
	■ Ha nem lehetséges			
	<b>Lyuknál deformálódott</b>		088244	
	■ Ha a lyuk eredeti geometriája megmarad			
	■ Ha nem marad meg			
■ Vagy repedés az anyagban				

# PERI Bérleti kritériumok

## Ipari állványok











UP Végkorlát UPA (130476; 130583)	Leírás	Instrukció	Fizetési kondíciók	Típus
	<b>Csap deformálódott</b>			
	<ul style="list-style-type: none"> <li>■ Ha lehetséges (Csap behelyezése lehetséges)</li> </ul>		 088244	
	<ul style="list-style-type: none"> <li>■ Ha nem lehetséges</li> </ul>			
	<b>Villa elgörbült</b>			
	<ul style="list-style-type: none"> <li>■ Ha lehetséges (Védőkorlát csatlakoztatása lehetséges)</li> </ul>		 088244	
<ul style="list-style-type: none"> <li>■ Ha nem lehetséges</li> </ul>				

# PERI Bérleti kritériumok

## Ipari állványok











Védőkoriát (110478; 116691)	Leírás	Instrukció	Fizetési kondíciók	Típus
	<b>Bearing elhajlott   használhatatlan</b>	 110565 (Bearing)		
	<b>Cső elhajlott / horpadt</b>  ■ Koriát nem csatlakoztatható			



# PERI Bérleti kritériumok

## Ipari állványok



Vízszintes heveder UPK (110072; 116695; 117192)	Leírás	Instrukció	Fizetési kondíciók	Típus
	<p>Horpadás a profilban</p> <ul style="list-style-type: none"><li>■ Éleket nem érinti</li></ul>			
	<p>Ékház nyitott   Ék hiányzik</p>			



# PERI Bérleti kritériumok

## Ipari állványok



Vízszintes heveder UPK (110072; 116695; 117192)	Leírás	Instrukció	Fizetési kondíciók	Típus
---	--------	------------	--------------------	-------



Élet érintő horpadás

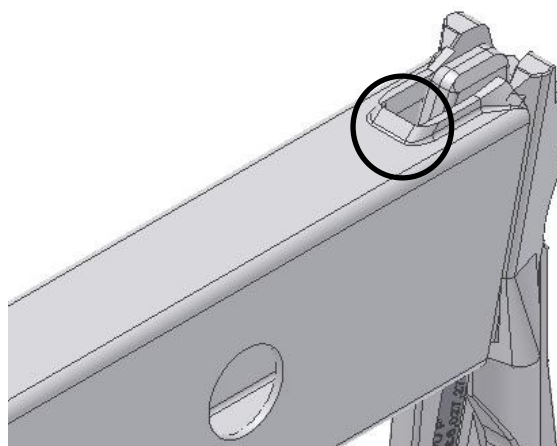

Perem horpadt

■ Ha lehetséges



088244



■ Ha nem lehetséges



■ Vagy repedés az anyagban



# PERI Bérleti kritériumok

## Ipari állványok



Vízszintes heveder UPK (110072; 116695; 117192)	Leírás	Instrukció	Fizetési kondíciók	Típus
---	--------	------------	--------------------	-------



### Lyuknál deformálódott

- Ha lehetséges és eredeti geometria megmarad
- Ha nem lehetséges
- Vagy repedés az anyagban



088244

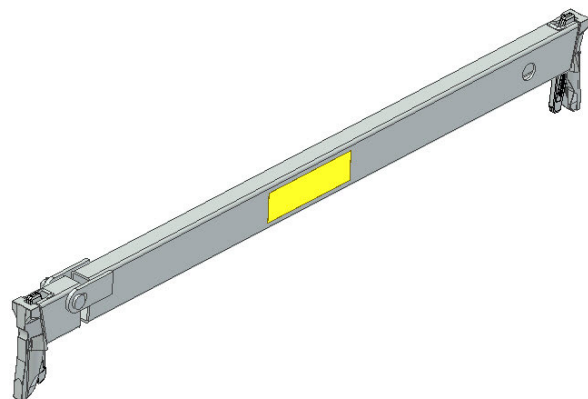

### Hajlott Heveder

- Minden látható deformáció















# PERI Bérleti kritériumok

## Ipari állványok

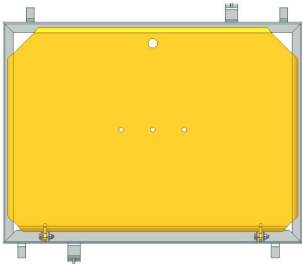

### UP Kibúvóelem UAF | UP Fedőlemez UDP

	Leírás	Instrukció	Fizetési kondíciók	Típus
	Horog súlyosan deformálódott, leszakadt			
	Ékes rögzítő megrepedt			
	Ajtó sérült   Használhatatlan	 110214 (75x100) 110275 (50x75)		

# PERI Bérleti kritériumok

## Ipari állványok



Csuklós heveder UPK (110072; 116695; 117192)	Leírás	Instrukció	Fizetési kondíciók	Típus
--	--------	------------	--------------------	-------

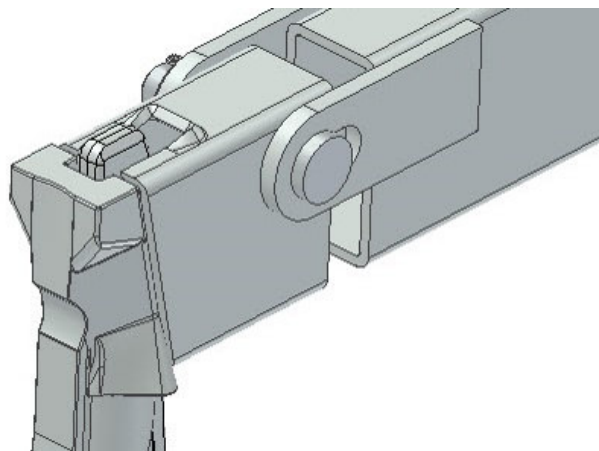

### Ékes csatlakozó

- Hiányzik
- Erőszak miatt sérült



110075 (ékes csatlakozó)



110075 (ékes csatlakozó)

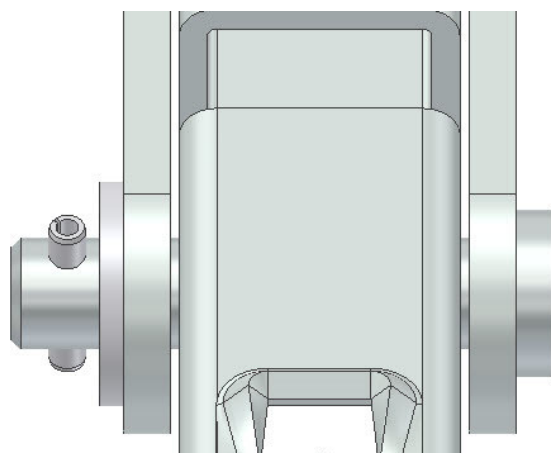

### Csap | hasított ék | alátét hiányzik



117451 (csap)  
722930 (hasított ék)  
780702 (alátét)



# PERI Bérleti kritériumok

## Ipari állványok



### UP Láblemez UPY

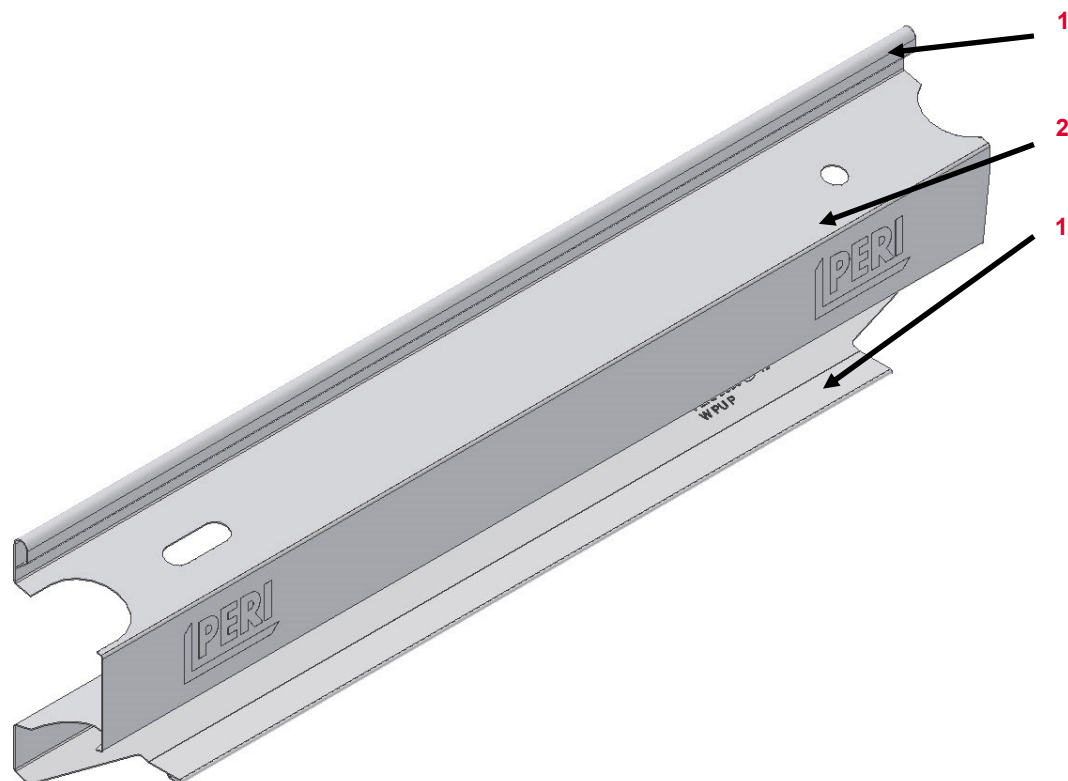

Sorszám	Megnevezés	Cikkszám
---------	------------	----------

1	Élek	
---	------	--



















2	Láblemez	
---	----------	--

Megnevezés	Cikkszám
UP Láblemez UPY 50	110213
UP Láblemez UPY 67	129947
UP Láblemez UPY 72	110526
UP Láblemez UPY 75	110514
UP Láblemez UPY 100	110073
UP Láblemez UPY 104	110076
UP Láblemez UPY 150	110160
UP Láblemez UPY 200	110176
UP Láblemez UPY 250	110208
UP Láblemez UPY 300	110211
UP Láblemez UPY 50 Galv.	117495
UP Láblemez UPY 72 Galv.	117938
UP Láblemez UPY 75 Galv.	117518
UP Láblemez UPY 100 Galv.	117981
UP Láblemez UPY 104 Galv.	123597
UP Láblemez UPY 150 Galv.	123694
UP Láblemez UPY 200 Galv.	123696
UP Láblemez UPY 250 Galv.	123698
UP Láblemez UPY 300 Galv.	123700

# PERI Bérleti kritériumok

## Ipari állványok



UP Láblemez	Leírás	Instrukció	Fizetési kondíciók	Típus
	<b>Élek deformálódtak</b> <ul style="list-style-type: none"> <li>■ Ha lehetséges</li> </ul>		 088244	
	<ul style="list-style-type: none"> <li>■ Ha nem lehetséges</li> </ul>			
	<b>Láblemez hosszában görbült</b> <ul style="list-style-type: none"> <li>■ Ha lehetséges és hajlás <math>\leq L/100</math></li> </ul>		 088244	
	<ul style="list-style-type: none"> <li>■ Ha nem lehetséges</li> <li>■ Vagy hajlás <math>&gt; L/100</math></li> </ul>			
	<b>Horpadás a felületen</b>		 088244	

# PERI Bérleti kritériumok

## Ipari állványok



### UP Lábdeszka UPF

Sorszám

Megnevezés

Cikkszám

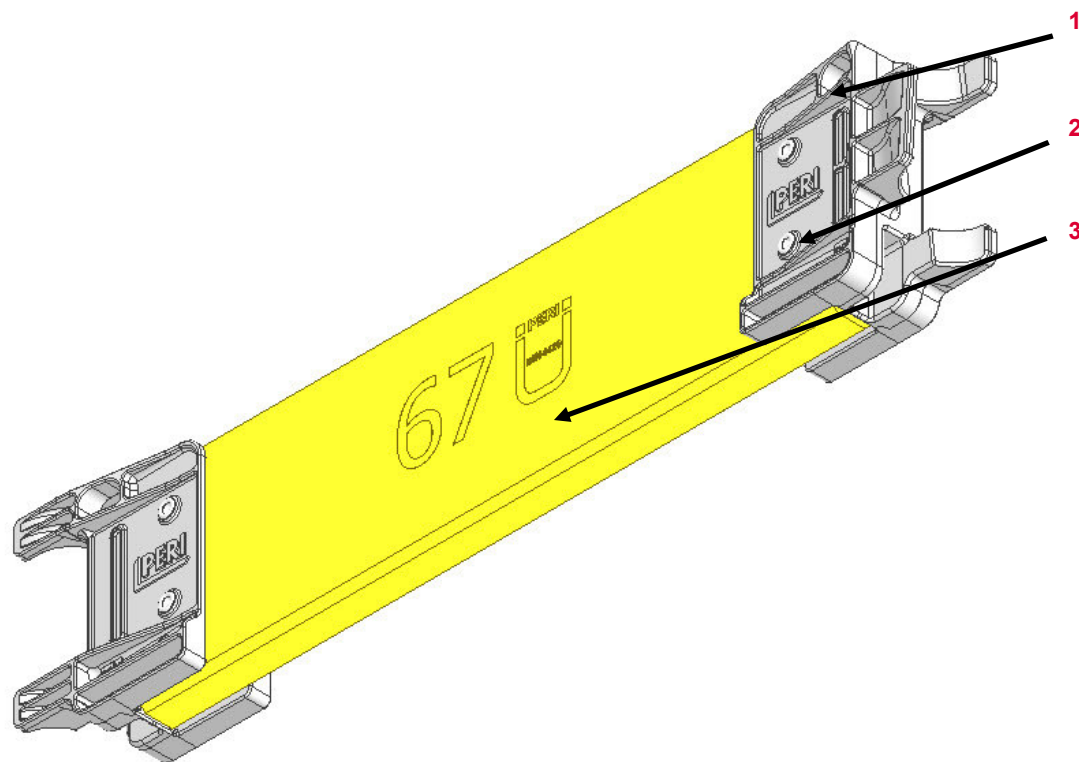

1 Lábdeszka csatlakozó

2 Szegecs

3 Lábdeszka

Megnevezés

Cikkszám









UP Lábdeszka UPF 50	129490
UP Lábdeszka UPF 67	129492
UP Lábdeszka UPF 75	129494
UP Lábdeszka UPF 100	129496
UP Lábdeszka UPF 150	129498
UP Lábdeszka UPF 200	129500
UP Lábdeszka UPF 250	129502
UP Lábdeszka UPF 300	129504



# PERI Bérleti kritériumok

## Ipari állványok



UP Lábdeszka UPF	Leírás	Instrukció	Fizetési kondíciók	Típus
	Villák roncsolódtak / letörtek			
	Lábdeszka <ul style="list-style-type: none"><li>Erőszak miatt törött</li></ul>			

# PERI Bérleti kritériumok

## Ipari állványok



### UP Kibúvóelem UAF | UP Fedőlemez UDP

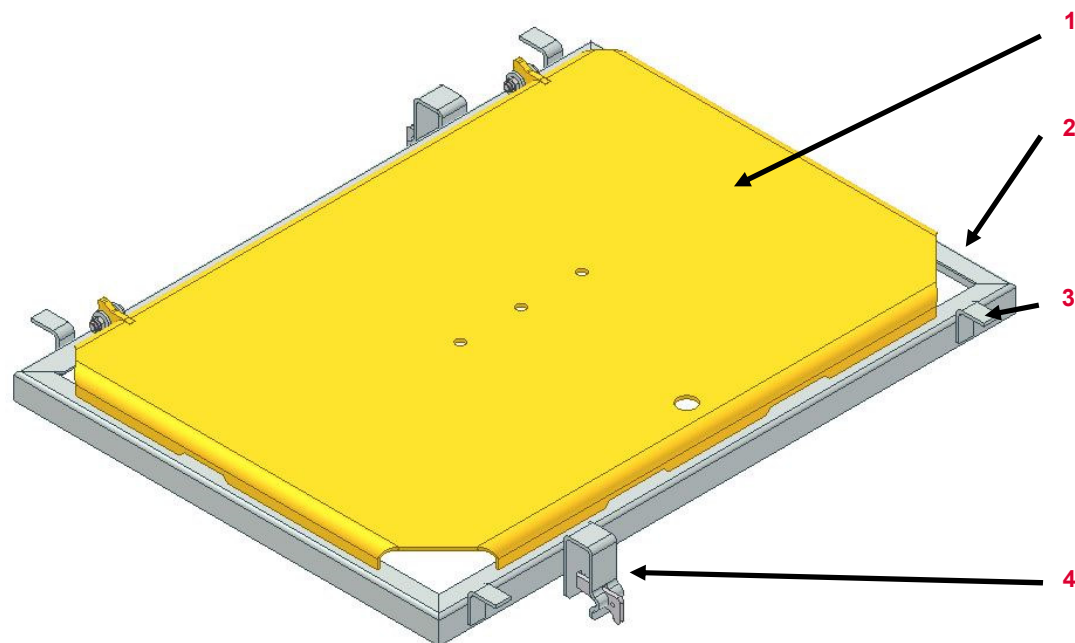

Sorszám	Megnevezés	Cikkszám
1	Ajtó	
2	Keret	
3	Horog	
4	Ékes rögzítő	

Megnevezés	Cikkszám
UP Kibúvóelem UAF 50x75	09783
UP Kibúvóelem UAF 75x100	109755
UP Fedőlemez UDP 75	111101
UP Fedőlemez UDP 100	112809
UP Saroklemez UDC 75	114148
UP Saroklemez UDC 100	113358

# PERI Bérleti kritériumok

## Ipari állványok



UP Létra UAF 200 (109879)	Leírás	Instrukció	Fizetési kondíciók	Típus
---------------------------	--------	------------	--------------------	-------

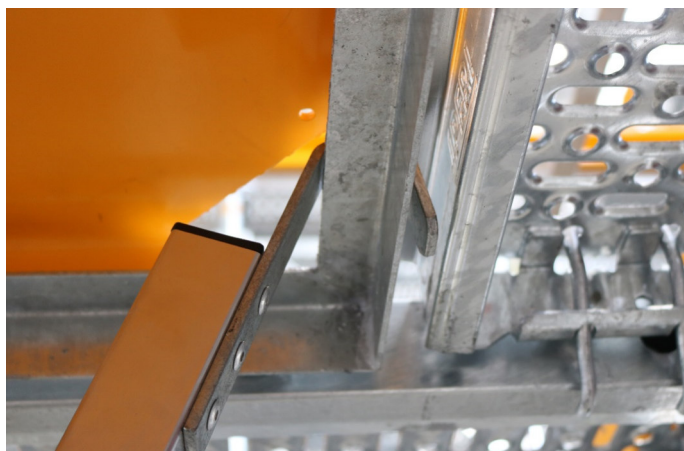

### Akasztó elhajlott

- Ha lehetséges
- Ha nem lehetséges
- Vagy repedés a zinc rétegben



109875 (Akasztó)  
104280 (Szegecs)

109875 (Akasztó)  
104280 (Szegecs)



088244



### Talp

- Hiányzik
- Vagy törött



110561 (Talp)  
125661 (Csavar)

110561 (Talp)  
125661 (Csavar)



# PERI Bérleti kritériumok

## Ipari állványok



### UP Toldócsap UH / UH-2 | Heveder Csatlakozó

Sorszám

Megnevezés

Cikkszám

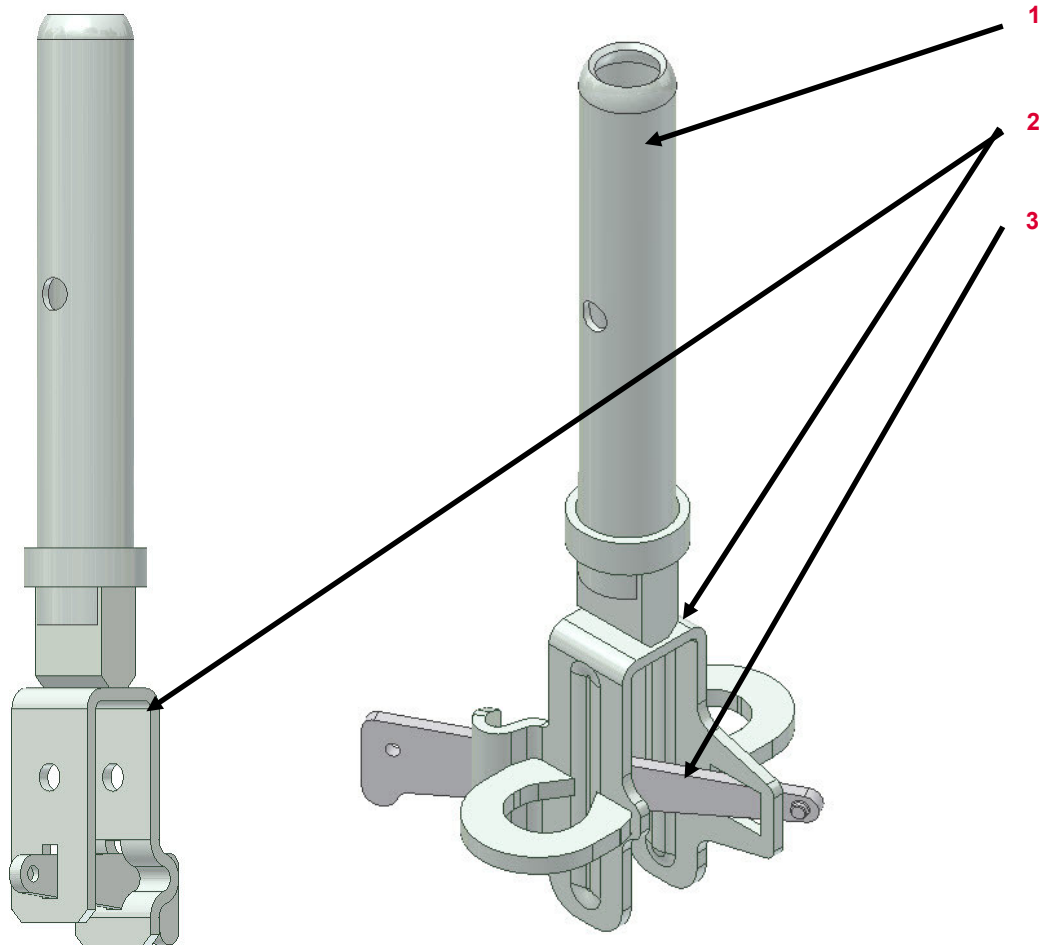

1

Csap

2

Akasztó

3

Ék

#### Megnevezés

#### Cikkszám

UP Toldócsap UH	109764
UP Toldócsap UH-2	130681
Heveder Csatlakozó UHA	101731
Heveder Csatlakozó Fél Rozetta UHA	110793
Csapos heveder csatlakozó fél rozetta UHA	110792
Csapos heveder csatlakozó fél rozetta UHA-2	130684

# PERI Bérleti kritériumok

## Ipari állványok



UH Toldócsap   Csapos Heveder Csatlakozó	Leírás	Instrukció	Fizetési kondíciók	Típus
--	--------	------------	--------------------	-------



Csap elgörbült | Horpadt



Akasztó deformálódott

- Ha lehetséges és nincs repedés a zinc rétegben



088244











- Ha nem lehetséges



# PERI Bérleti kritériumok

## Ipari állványok















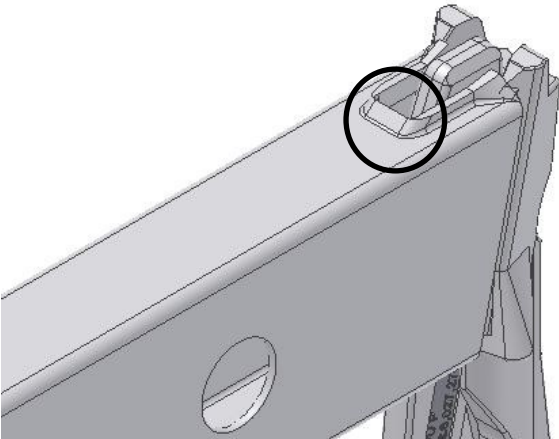

Létra kapcsoló UAC-2 (124813)	Leírás	Instrukció	Fizetési kondíciók	Típus
	<p>Horpadás a profilon</p> <ul style="list-style-type: none"><li>■ Éleket nem érinti</li></ul>			
	<p>Ékház nyitott   Ék hiányzik</p>			

# PERI Bérleti kritériumok

## Ipari állványok



Létra kapcsoló UAC-2 (124813)	Leírás	Instrukció	Fizetési kondíciók	Típus
	<p>Éleket érintő horpadás a profilon</p>			
	<p><b>Perem horpadt</b></p> <ul style="list-style-type: none"> <li>■ Ha lehetséges</li> </ul>		 088244	
	<ul style="list-style-type: none"> <li>■ Ha nem lehetséges</li> </ul>			
	<ul style="list-style-type: none"> <li>■ Vagy repedés az anyagban</li> </ul>			



# PERI Bérleti kritériumok

## Ipari állványok



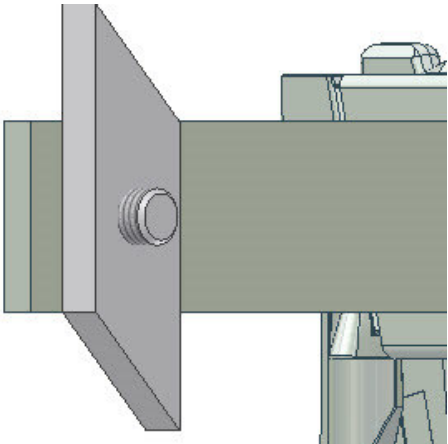











Létra kapcsoló UAC-2 (124813)	Leírás	Instrukció	Fizetési kondíciók	Típus
	<b>Lyuknál deformálódott</b>			
	<ul style="list-style-type: none"> <li>■ Ha lehetséges és eredeti geometria megmarad</li> </ul>		088244	
	<ul style="list-style-type: none"> <li>■ Ha nem</li> </ul>			
	<ul style="list-style-type: none"> <li>■ Vagy repedés az anyagban</li> </ul>			
	<b>Rögzítő lemez</b>			
	<ul style="list-style-type: none"> <li>■ Hiányzik</li> </ul>	701763 (Rögzítő lemez) 710266 (Csavar)		
	<ul style="list-style-type: none"> <li>■ Vagy nem működik</li> </ul>	701763 (Rögzítő lemez) 710266 (Csavar)		

# PERI Bérleti kritériumok

## Ipari állványok



UP Futómacska UFS 20 (126497)	Leírás	Instrukció	Fizetési kondíciók	Típus
	<b>Kerék</b>	<ul style="list-style-type: none"> <li data-bbox="875 564 1122 590">■ Elhasználódott  127436 (Kerék)</li> </ul>		
	<ul style="list-style-type: none"> <li data-bbox="875 708 1122 734">■ Erőszak miatt sérült</li> </ul>	 127436 (Kerék)		
	<b>Csap   Sasszeg</b>	<ul style="list-style-type: none"> <li data-bbox="875 1075 999 1101">■ Hiányzik  018050 (Csap) 018060 (Sasszeg)</li> </ul>		
	<ul style="list-style-type: none"> <li data-bbox="875 1219 1223 1244">■ Erőszak miatt használhatatlan</li> </ul>	 018050 (Csap) 018060 (Sasszeg)		

# PERI Bérleti kritériumok

## Ipari állványok



UP Futómacska UFS 20 (126497)	Leírás	Instrukció	Fizetési kondíciók	Típus
-------------------------------	--------	------------	--------------------	-------



### Csap csatlakozása deformálódott

- Ha lehetséges (Csatlakozás lehetséges)
- Vagy ha nem



127447 (Csap csatlakozó)



088244



# PERI Bérleti kritériumok

## Ipari állványok



### UP Köztes elem | UP Végelem ULS Flex

Sorszám

Megnevezés

Cikkszám

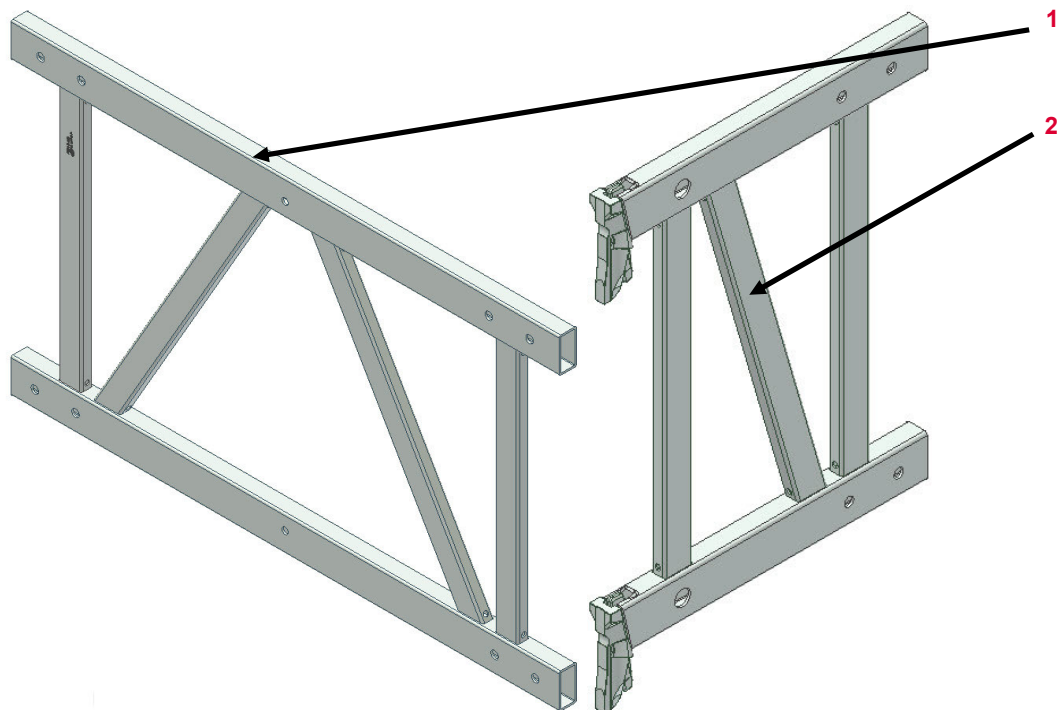

1

Keret

2

Merevítő

#### Megnevezés

#### Cikkszám

UP Köztes elem ULS 100 FLEX

124795

UP Köztes elem ULS 125 FLEX

124790

UP Köztes elem ULS 150 FLEX

124781

UP Végelem ULS 50 FLEX

124805

# PERI Bérleti kritériumok

## Ipari állványok



UP Köztes elem   UP Végelem ULS Flex	Leírás	Instrukció	Fizetési kondíciók	Típus
--------------------------------------	--------	------------	--------------------	-------



### Elem deformálódott | Csatlakozásnál horpadt

- Ha lehetséges és csapok behelyezhetők
- Ha nem lehetséges
- Vagy repedés a zinc rétegben



088244



### Kertet | Merevítő hajlott

- Funkcióját betölti
- Vagy nem
- Vagy megtört



# PERI Bérleti kritériumok

## Ipari állványok



UP Összekötő elem ULS Flex (124806)	Leírás	Instrukció	Fizetési kondíciók	Típus
-------------------------------------	--------	------------	--------------------	-------



### Csatlakozónál horpadt, görbült

- Ha lehetséges és csapok behelyezhetők
- Ha nem lehetséges
- Vagy repedés a zinc rétegben



088244



### Csap / Sasszeg

- Hiányzik
- Erőszak miatt használhatatlan



018060 (Sasszeg)  
124771 (Csap)

018060 (Sasszeg)  
124771 (Csap)





# PERI Bérleti kritériumok

## Ipari állványok



### UP Biztonsági Ajtó UPS (125672 | 126675)

Sorszám      Megnevezés      Cikkszám

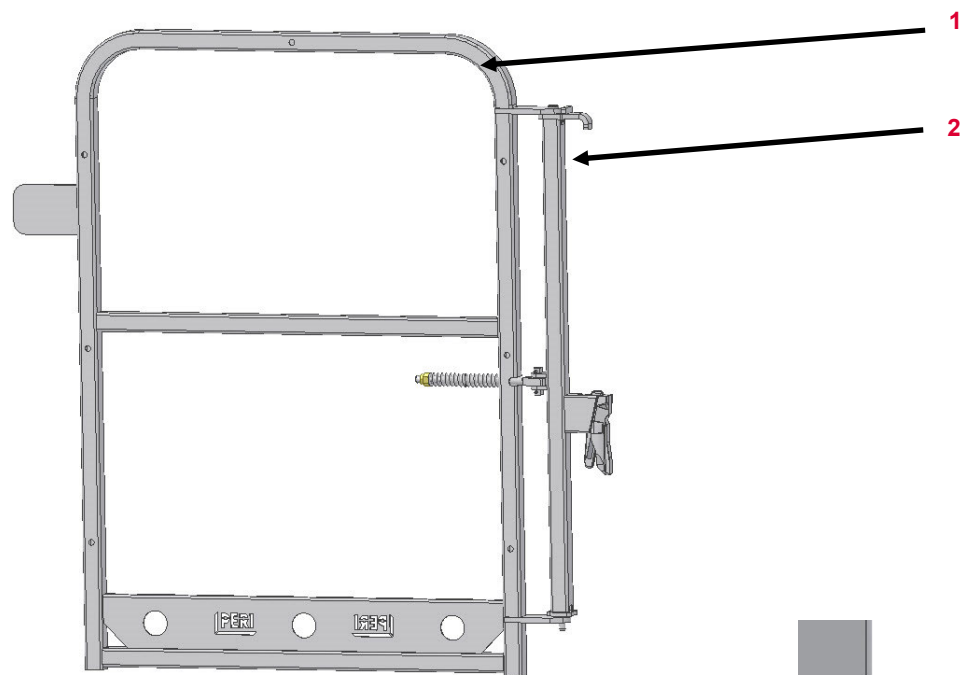

1	Biztonsági ajtó	
2	Vezető fogantyú	123829
3	Anyá	113064
4	Rugó	126560
5	Szemcsavar	125671
6	Csap Biztonsági ajtó	126747
7	Hasított ék 4x26	710683
8	Csap10x24	126471
9	Hasított ék 3x16	710916

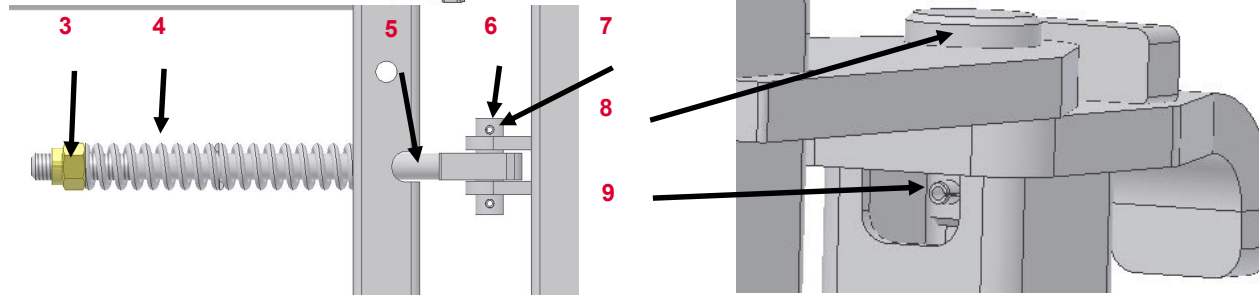



















# PERI Bérleti kritériumok

## Ipari állványok











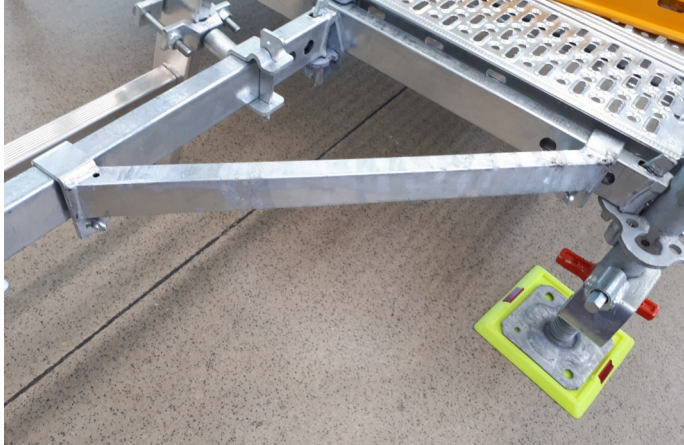





UP Biztonsági Ajtó UPS	Leírás	Instrukció	Fizetési kondíciók	Típus
	<p><b>Alkatrészek</b></p> <ul style="list-style-type: none"> <li>■ Hiányzik</li> <li>■ Vagy erőszak miatt sérült</li> <li>■ Vagy kopott (rugó)</li> </ul>	<ul style="list-style-type: none"> <li></li> <li></li> <li></li> </ul>	<ul style="list-style-type: none"> <li></li> <li></li> <li></li> </ul>	<ul style="list-style-type: none"> <li></li> <li></li> <li></li> </ul>
	<p><b>Deformálódott részek</b></p> <ul style="list-style-type: none"> <li>■ Ha lehetséges</li> <li>■ Ha nem lehetséges</li> </ul>	<ul style="list-style-type: none"> <li></li> <li></li> </ul>	<ul style="list-style-type: none"> <li></li> <li></li> </ul>	<ul style="list-style-type: none"> <li></li> <li></li> </ul>

# PERI Bérleti kritériumok

## Ipari állványok



UP Vízszintes Heveder Merevítő UAD (134512)	Leírás	Instrukció	Fizetési kondíciók	Típus
	<p>Látható deformáció</p>			
	<p>Csatlakozó deformálódott</p> <ul style="list-style-type: none"> <li data-bbox="875 1090 1061 1114">■ Ha lehetséges</li> <li data-bbox="875 1233 1113 1257">■ Ha nem lehetséges</li> <li data-bbox="875 1369 1120 1393">■ Vagy hiányzik az ék</li> </ul>			
				
				

# PERI Bérleti kritériumok

## Ipari állványok



UP Létra Csatlakozó UAM-S (134520)	Leírás	Instrukció	Fizetési kondíciók	Típus
------------------------------------	--------	------------	--------------------	-------



Csavar hiányzik, sérült



115007 (Csavar M12x85)

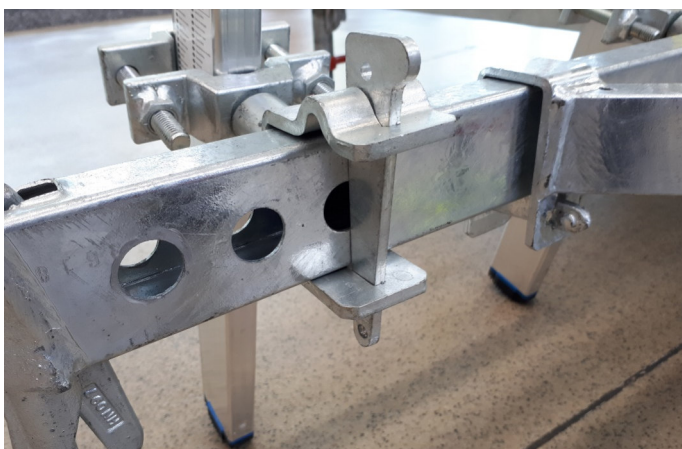

Csatlakozónál elhajlott

■ Ha lehetséges



■ Ha nem lehetséges











■ Vagy hinyzik az ék

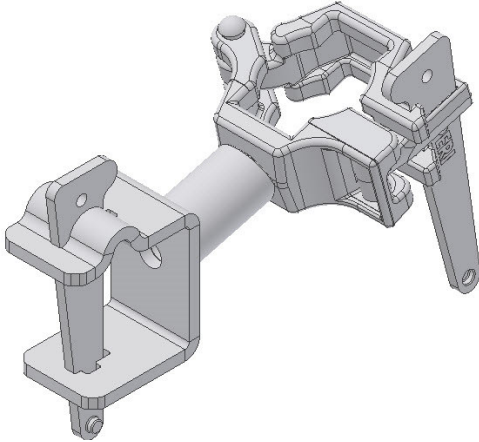

# PERI Bérleti kritériumok

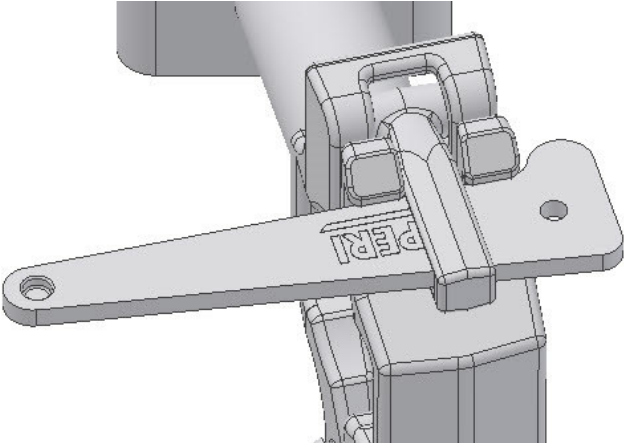
## Ipari állványok



















UP Létra Csatlakozó UAM-W (134527)	Leírás	Instrukció	Fizetési kondíciók	Típus
	Deformálódott			
	Ék Hiányzik			

# PERI Bérleti kritériumok

## Magyarázat



Ikon	Leírás	Ikon	Leírás	Ikon	Leírás
	Nem Ok– Selejtezendő		Ügyfélnek számlázandó		Optikai kár
	OK– marad a bérleti parkban		Nincs számlázás		Funkcionális sérülés
	Selejt anyag– biztonsági okokból az anyagot tilos kiadni		Anyagot levágni		Funkcionális sérülés— anyag kiadása nem engedélyezett
	Javítás az előírások szerint		Anyagot megjelölni		Statikai sérülés— anyag kiadása nem engedélyezett
	Hideg egyengetés– utána a varratokat és a környékét ellenőrizni kell		Sérült anyag cseréje		
	Javítás gazdaságosság függvényében		Hiányzó anyag pótlása		
	Megtisztítani az anyagot				