

PERI Bérleti kritériumok

SB Egyoldali támbak



Kapcsolat

**PERI Kft,
zsuzlatok, állványzatok,
mérnöki szolgáltatás**

H-1181 Budapest
Zádor u. 9.
Tel.:+36-1-296-09-60
www.peri.hu

Tartalom	Oldal
Egyoldali támbak	2
Csatlakozó SB-A, B, C	9
Gördítőkerék SB-A,B	10
SB lekötés	11
Csatlakozó SB-1,2	13
SB-L horganykonzol	14
SB horgonylemez horgonylazító lemez	15
SB Adapter	16
SB függesztő papucs	18

Változtatások	Dátum ü	Oldal
Új verzió	07/2021 O.L.	
Hozzáadott sérülések 12.37 és 12.38	10/2018 fw	7
H- Profil hozzáadaása a merevítőkeret vázához	08/2019 fw	8

PERI Bérleti kritériumok

SB Egyoldali támbak



Egyoldali támbak

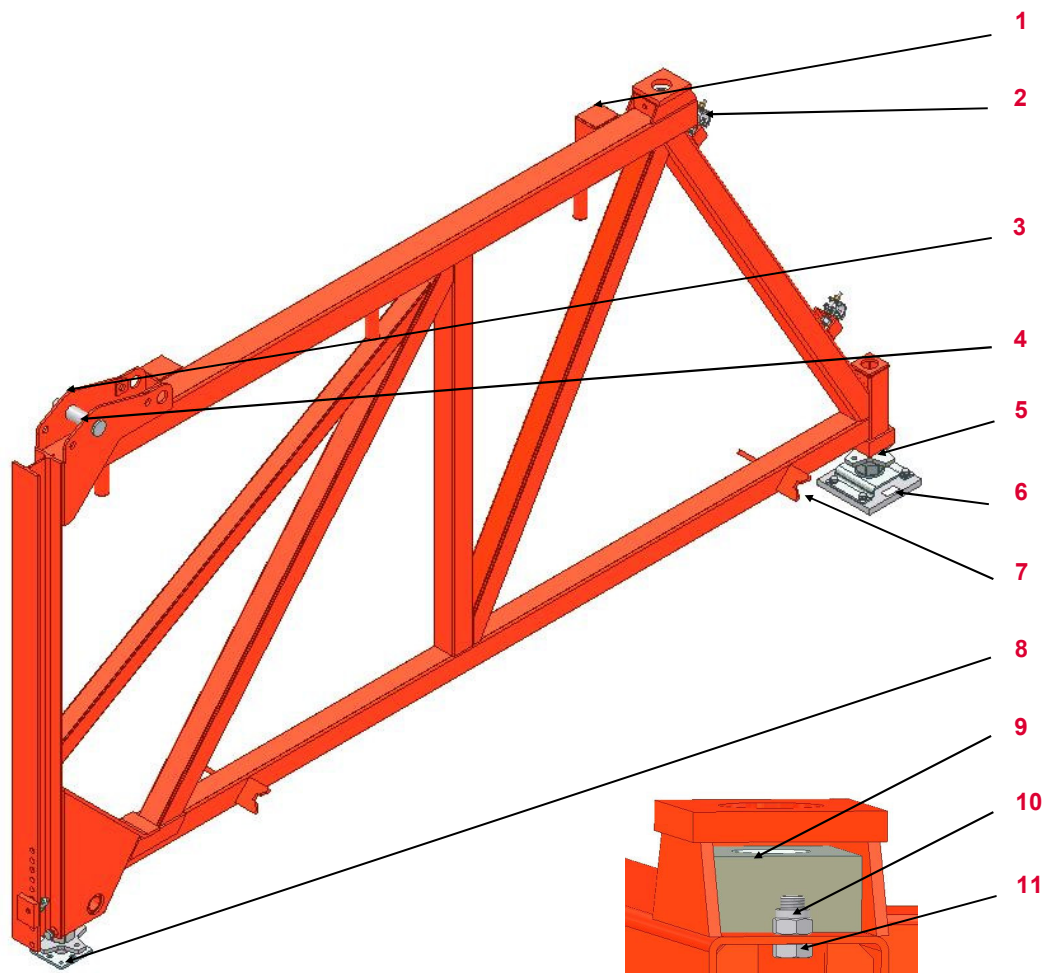

Sorszám	Megnevezés	Cikkszám
1	Cső	108871
2	Csőbilincs csavaros 48	017040
3	Sasszeg 8 Din 11024-Verz	710618
4	Biztosítócsap D50 x 150	710545
5	TR50*8 HR szárny szabály. anya	700554
6	Csavaros talp	025730
7	Rakatólási segéd	107291
8	TR50*8 Csavaros talp	700555
9	SB Csavarm Alátét	710541
10	Önzáró skt anya	070890
11	Hatlapú csavar M 16	710231

Megnevezés	Cikkszám
Egyoldali támbak SB-A0	025690
Egyoldali támbak SB-A	025700
Egyoldali támbak SB-B	025710
Egyoldali támbak SB-C	025720
Egyoldali támbak SB-1	027500
Egyoldali támbak SB-2	027510

PERI Bérleti kritériumok

SB Egyoldali támbak











Egyoldali támbak	Leírás	Instrukció	Fizetési kondíció	Típus	
	Horpadás a zártszelvényen	<ul style="list-style-type: none"> ■ ≤ 8 mm és az élek nem érintettek 			
	<ul style="list-style-type: none"> ■ > 8 mm és az élek nem érintettek 				
	<ul style="list-style-type: none"> ■ Vagy az élek érintettek 				
	Rés (vágás) a zártszelvényen				

PERI Bérleti kritériumok

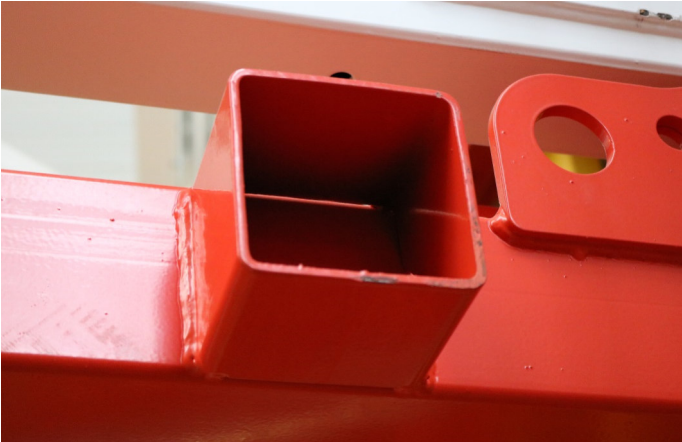
SB Egyoldali támbak













Egyoldali támbak	Leírás	Instrukció	Fizetési kondíció	Típus
	Rakatólási segéd deformálódott			
	Rakatólási segéd deformálódott Horpadt			

PERI Bérleti kritériumok

SB Egyoldali támbak











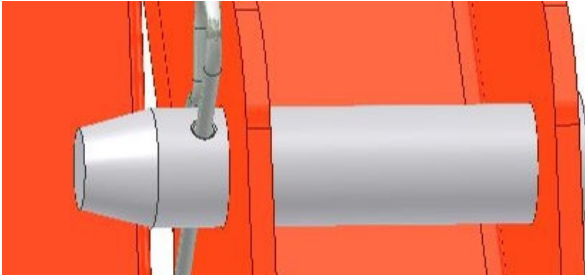





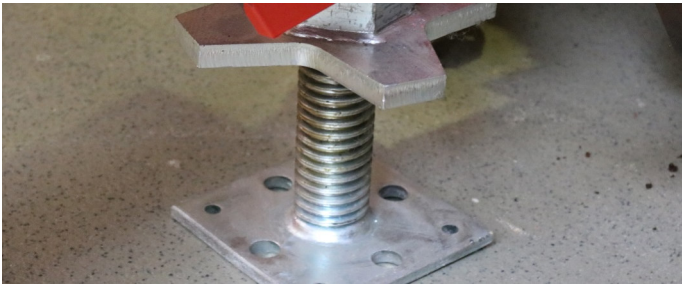

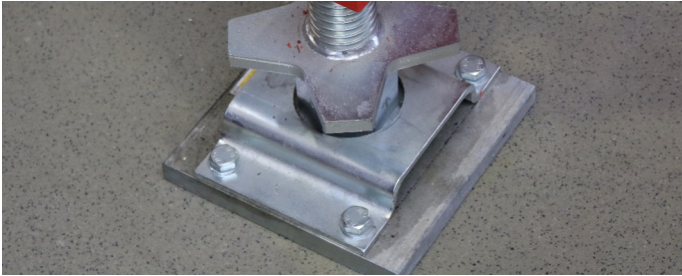

Egyoldali támbak	Leírás	Instrukció	Fizetési kondíció	Típus
	<p>Csőbilincs 48 csavaros</p> <ul style="list-style-type: none"> ■ Hiányos vagy hiányzik ■ Vagy erőhatás miatti sérült 	<p></p> <p></p>	<p> 088461</p> <p> 088461</p>	<p></p> <p></p>
	<p>A lyuk sérült a csőbilincs csatlakozásánál</p>	<p></p>	<p> 088474</p>	<p></p>

PERI Bérleti kritériumok

SB Egyoldali támbak



Egyoldali támbak	Leírás	Instrukció	Fizetési kondíció	Típus
	Csap Sasszeg			
	<ul style="list-style-type: none"> ■ Hiányzik 		 088462	
	<ul style="list-style-type: none"> ■ Vagy erőhatás miatti sérülés 		 088462	
	Csavaros talp Tr 50x8			
	<ul style="list-style-type: none"> ■ Hiányzik 		 088465	
	<ul style="list-style-type: none"> ■ Vagy erőhatás miatti sérülés 		 088465	
	Csavaros talp Tr60x9			
	<ul style="list-style-type: none"> ■ Hiányzik 		 088466	
	<ul style="list-style-type: none"> ■ Vagy erőhatás miatti I sérülés 		 088466	

PERI Bérleti kritériumok

SB Egyoldali támbak



Egyoldali támbak	Leírás	Instrukció	Fizetési kondíció	Típus
	<p>Szintező anya</p> <ul style="list-style-type: none"> ■ Kopott (nem egyenletes a szárnyaknál) 	700554 (szárnyas Szint. Anya)		
	<ul style="list-style-type: none"> ■ vagy erőhatás következtében sérült 	700554 (szárnyas szint. anya)		
	<ul style="list-style-type: none"> ■ Vagy hiányzik 	700554 (szárnyas Szint. anya)		
	<p>Rögzítőcsavar</p> <ul style="list-style-type: none"> ■ Rozsdás (funkcionális hiba) 	710542 (Tartó csavar) Mindig kenje be a csavart		
	<ul style="list-style-type: none"> ■ Vagy hiányzik 			

PERI Bérleti kritériumok

SB Egyoldali támbak



Egyoldali támbak	Leírás	Instrukció	Fizetési kondíció	Típus
------------------	--------	------------	-------------------	-------



H- profil meghajlott



PERI Bérleti kritériumok

SB Egyoldali támbak



Csatlakozó SB-A, B, C - MX/TR/D (025740)	Leírás	Instrukció	Fizetési kondíció	Típus
--	--------	------------	-------------------	-------



A menet nem mozgatható

- Kopott



- vagy erőhatás következtében sérült

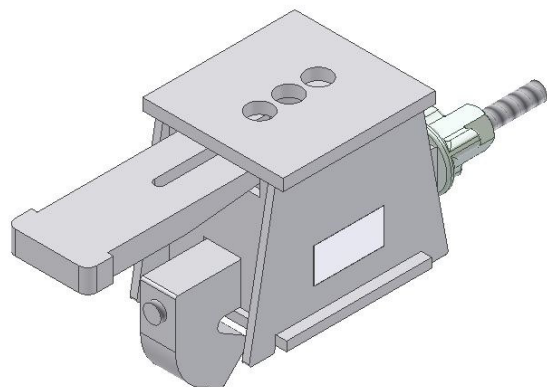











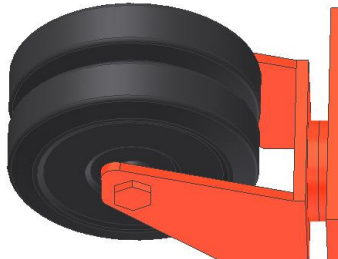



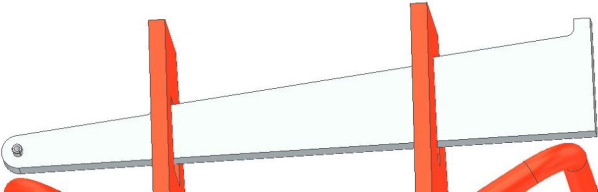

Ék elhajolva funkcióját nem látja el

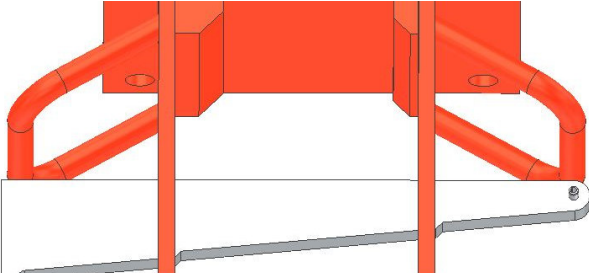

PERI Bérleti kritériumok

SB Egyoldali támbak



Gördítőkerék SB-A,B (025750)	Leírás	Instrukció	Fizetési kondíció	Típus
	Gördítőkerék			
	<ul style="list-style-type: none"> ■ Kopott 			
	<ul style="list-style-type: none"> ■ Erőhatás következtében sérült 		 088495	
	Ék hajlott			
		 722123 (ék) 780802 (hasított ék)	 088481	
	Konzol Ütközőlemez hajlott			
	<ul style="list-style-type: none"> ■ Ha lehetséges 		 088244	
	<ul style="list-style-type: none"> ■ Ha nem lehetséges 			

PERI Bérleti kritériumok

SB Egyoldali támbak



Lekötés SB-1, 2 (027590)	Leírás	Instrukció	Fizetési kondíció	Típus
--------------------------	--------	------------	-------------------	-------



Horog meghajlott



722657 (Horog R20)
722658 (Horog R26)

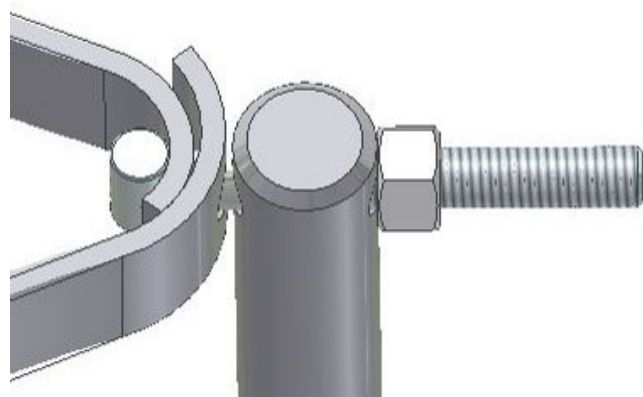

Kalapácsfejű csavar | Anya

■ Hiányzik



710290 (Kalapácsfejű csavar)
710341 (csavaranya)



088492



■ vagy erőhatás következtében sérült



710290 (Kalapácsfejű csavar)
710341 (csavaranya)



088492



PERI Bérleti kritériumok

SB Egyoldali támbak



Horog SB-2, asszimetrikus(116078)	Leírás	Instrukció	Fizetési kondíció	Típus
-----------------------------------	--------	------------	-------------------	-------

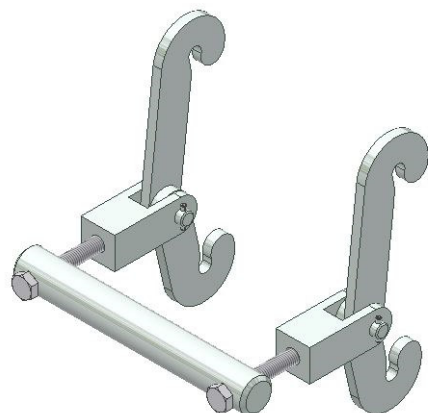

Horog

- Hiányzik
- vagy erőhatás következtében sérült



116071 (Hosszú horog)
116069 (Rövid horog)



116071 (Hosszú horog)
116069 (Rövid horog)



Hatlapfejű csavar | Csap | Hüvely

- Hiányzik



116073 (Csap D 12)
722930 (Hüvely)
115007 (Hatlapfejű csavar M12)

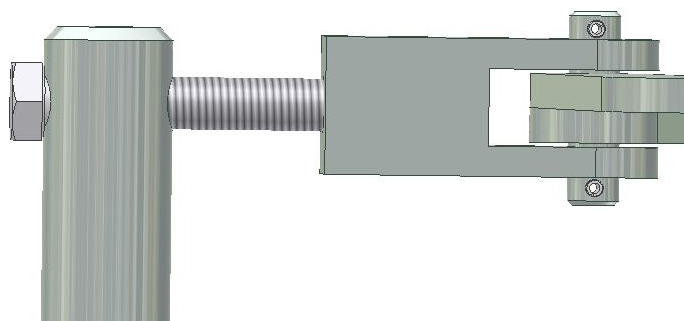

PERI Bérleti kritériumok

SB Egyoldali támbak



SB Trio Csatlakoztató elem –1, 2 (027680)	Leírás	Instrukció	Fizetési kondíció	Típus
	<p>Ék hajlott, funkcióját nem látja el</p>			
	<p>Kopott darufelfüggesztés</p> <ul style="list-style-type: none"> ■ Mérés ≤ 22,5 mm 			
	<p>Ütközőlemez deformálódott</p> <ul style="list-style-type: none"> ■ Ha lehetséges ■ Vagy ha nem lehetséges 			

088244

PERI Bérleti kritériumok

SB Egyoldali támbak



SB-L horgonykonzol (100903)	Leírás	Instrukció	Fizetési kondíció	Típus
-----------------------------	--------	------------	-------------------	-------

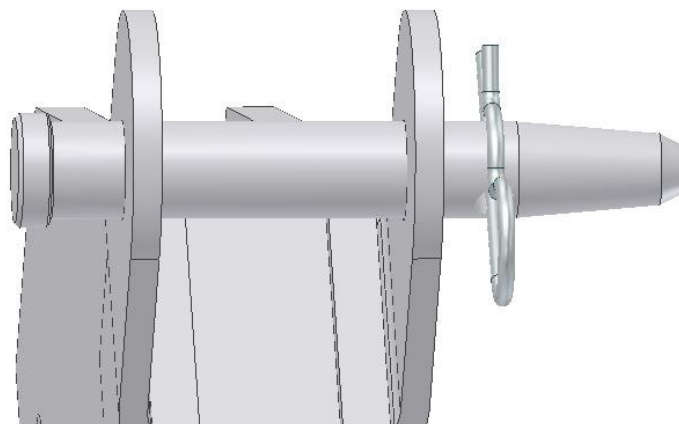

Csap | Sasszeg hiányzik



105400 (Csap)
018060 (Sasszeg)



088178

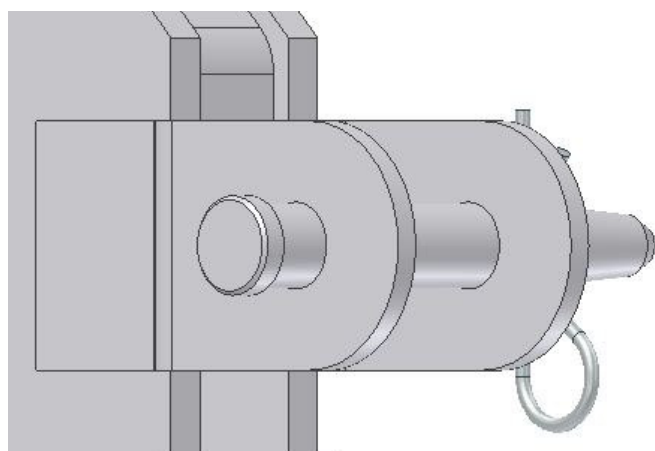

Lemez deformálódott

■ Ha lehetséges



088244











■ Vagy ha nem lehetséges



PERI Bérleti kritériumok

SB Egyoldali támbak



SB horgonylemez Horgonylazító lemez	Leírás	Instrukció	Fizetési kondíció	Típus
(101621, 027480)	<p>Hatlapfejű csavar</p> <ul style="list-style-type: none"> ■ Hiányzik ■ vagy erőhatás következtében sérült 	<p>724563</p>  <p>724563</p> 	 	 
	<p>Horgonylemez hiányzó levágott meghajlott vezető fül</p>		 <p>088472</p>	

PERI Bérleti kritériumok

SB Egyoldali támbak



SB adapter SB-A0, A, B (106662)	Leírás	Instrukció	Fizetési kondíció	Típus
---------------------------------	--------	------------	-------------------	-------

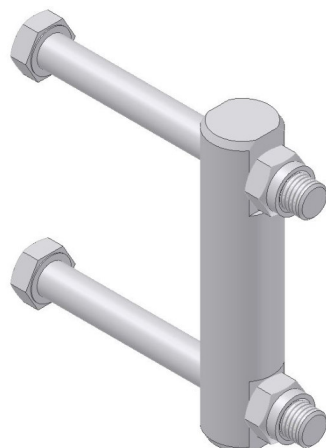

Hatlapfejű csavar | Csavaranya

- Elgöbült
- Vagy hiányzik



106797 (hatlapfejű csavar)
106803 (csavaranya)



088492
088489



106797 (hatlapfejű csavar)
106803 (csavaranya)



088492
088489



Tengely sérült| hiányzik

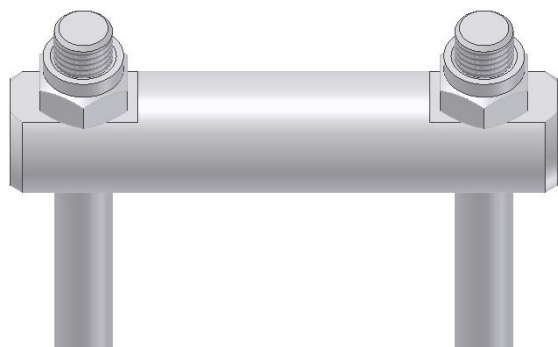

PERI Bérleti kritériumok

SB Egyoldali támbak











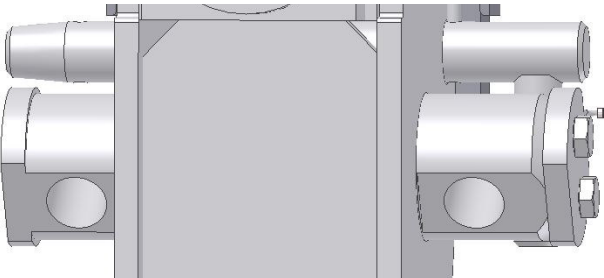





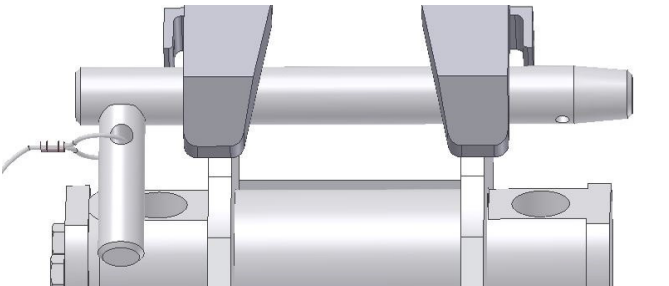

Alapkeret adapter SB-2 (106663)	Leírás	Instrukció	Fizetési kondíció	Típus		
	Hatlapfejű csavar					
	■ Elgöbült		106798 (Hatlapfejű csavar M24x 500) 106803 (Csavaranya)		088492 088489	
	■ Vagy hiányzik		106798 (Hatlapfejű csavar M24x 500) 106803 (Csavaranya)		088492 088489	
	Tengely sérült					
			106732 (Tengely D=60)			
	Fő rész deformálódott					
	■ Ha lehetséges				088244	
	■ Vagy ha nem lehetséges					

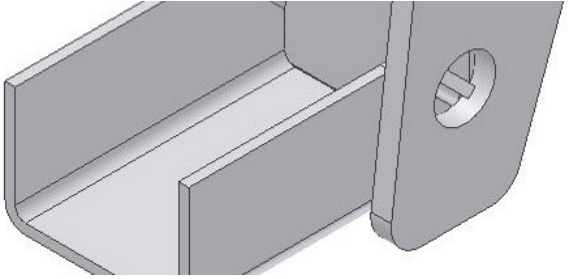
PERI Bérleti kritériumok

SB Egyoldali támbak











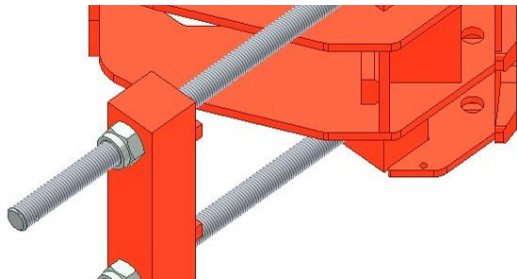



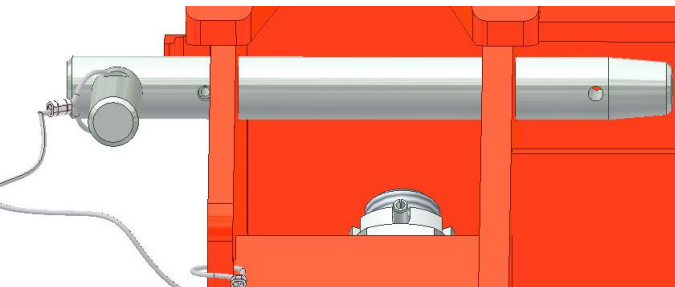

SB függesztő papucs (106661)	Leírás	Instrukció	Fizetési kondíció	Típus
	<p>Tengely használhatatlan</p> <ul style="list-style-type: none"> ■ Kopott ■ Vagy erőhatás következtében sérült 	 	  088494	 
	<p>Csap hiányzik</p>	 715585 (Csap) 127303 (Sodort köté)l 127302 (rögzítő 2db)	 088478	
	<p>U- Profil deformálódott</p> <ul style="list-style-type: none"> ■ Ha lehetséges ■ Vagy nem lehetséges 	 	 	 

PERI Bérleti kritériumok

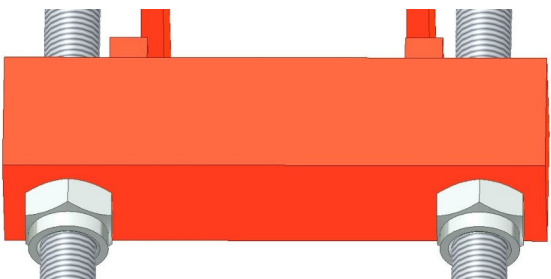
SB Egyoldali támbak









Fali állvány zsanér SB dupla (111866)	Leírás	Instrukció	Fizetési kondíció	Típus
	Csavar Csavaranya			
	<ul style="list-style-type: none"> ■ Elgöbült ■ Vagy hiányzik 	<ul style="list-style-type: none">  112094 (Csavar) 725119 (Csavaranya) 706476 (Koronás anya)  112094 (Csavar) 725119 (Csavaranya) 706476 (Koronás anya) 	<ul style="list-style-type: none">  088496 088483 088484  088496 088483 088484 	<ul style="list-style-type: none">  
	Csap hiányzik	<ul style="list-style-type: none">  715585 (Csap) 127302 (Rögzítő 2db) 127303 (Sodort köté) 	<ul style="list-style-type: none">  088478 	<ul style="list-style-type: none"> 
	Ellen tartó hiányzik	<ul style="list-style-type: none">  112093 (Ellen tartó) 	<ul style="list-style-type: none">  088497 	<ul style="list-style-type: none"> 

PERI Bérleti kritériumok

Magyarázat



Ikon	Jelentés	Ikon	Jelentés	Ikon	Jelentés
	Nem OK — kicselezendő		Ügyfélnek leszámházandó		Optikai kár
	OK– marad a bérleti parkban		Nincs számlázás		Funkcionális sérülés
	Selejt anyag – biztonsági okokból az anyagot tilos kiadni		Anyagot levágni		Funkcionális sérülés — anyag kiadása nem engedélyezett
	Javítás az előírások szerint		Anyagot megjelölni		Statikai sérülés — anyag kiadása nem engedélyezett
	Hideg egyengetés — utána a varratokat és a környékét ellenőrzni kell		Sérült anyag cseréje		
	Javítás gazdaságosság függvényében		Hiányzó anyag pótlása		
	Megtisztítani az anyagot				