

PERI Bérleti kritériumok PROKIT



Kontakt

PERI kft,
zsaluzatok, állványzatok,
mérnöki szolgáltatás

H-1181 Budapest
Zádor u. 9.
Tel.: +36-1-296-09-60
www.peri.hu

Tartalom	Oldal	Változás	Dátum Által	Oldal
Prokit rácsos rorlát PMB	2	Új verzió	05/2021 Sz.L.	
Függeszthető rács	4			
Korlátoszlop PP Korlátoszlop toldó PPE	5			
Korlátoszlop tartó PDF PSF	6			
Korlátoszlop tartó PUC	7			
Korlátoszlop tartó PSC	8			
Magyarázat	9			

PERI Bérleti kritériumok

PROKIT





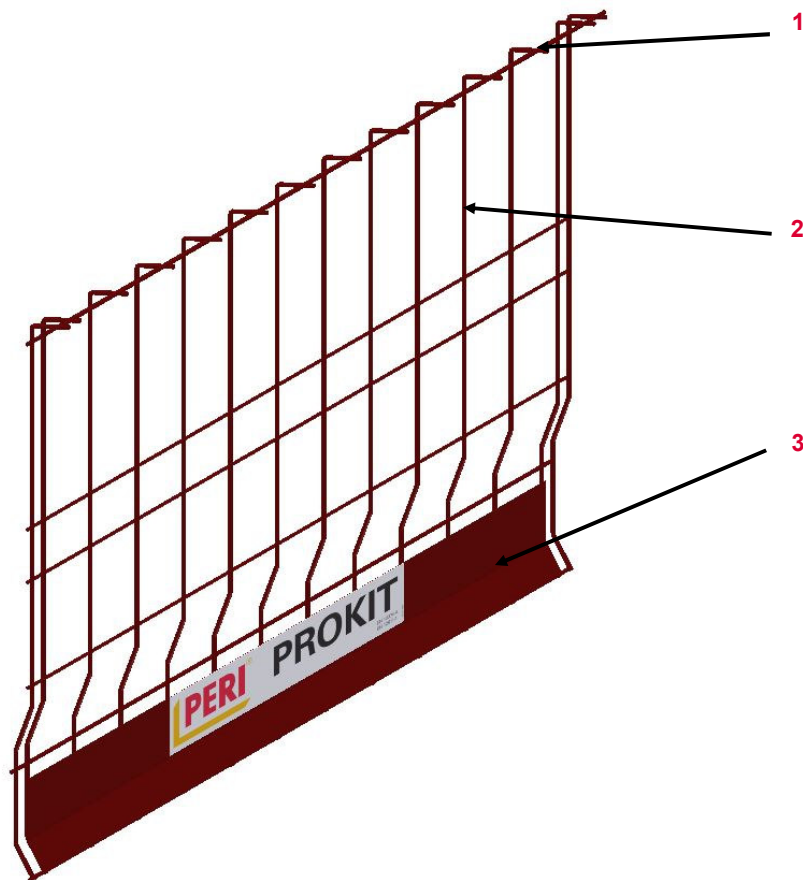















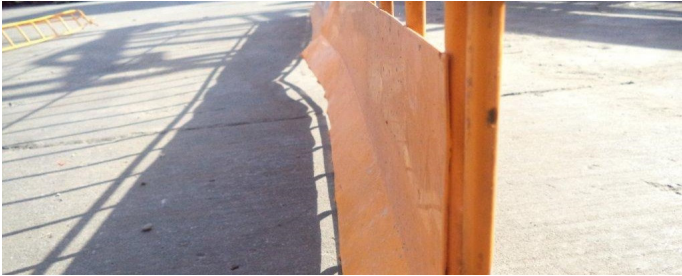







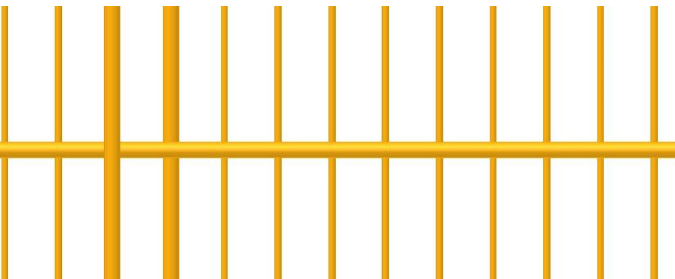



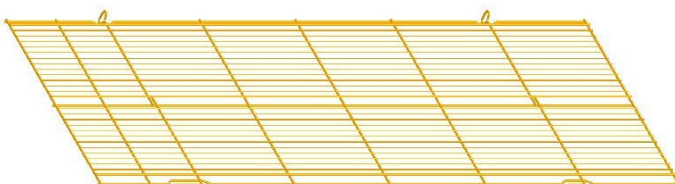

Prokit rácsos korlát PMB

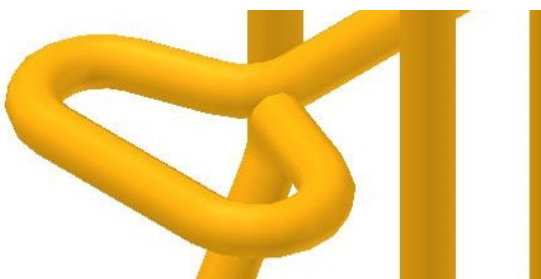

No.	Név	Cikkszám
1	Vízszintes sáv	
2	Függőleges sáv	
3	Láblemez	

Érvényes	Cikkszám
Prokit rácsos korlát PMB 240	126371
Prokit rácsos korlát PMB 120	126376
Prokit rácsos korlát PMB 90	126381
Prokit rácsos korlát PMB 130	117327
Prokit rácsos korlát PMB 260	117236

Prokit rácsos korlát PMB	Leírás	Instrukciók	Fizetési Kondíciók	Típus
	31.01 Sáv törött (max 3 rácspont)			
	31.02 Háló <ul style="list-style-type: none"> ■ Deformálódott > 15 mm 			
	<ul style="list-style-type: none"> ■ Vagy törött 			
	31.03 Láblemez deformálódott <ul style="list-style-type: none"> ■ Ha lehetséges 			
	<ul style="list-style-type: none"> ■ Vagy ha nem lehetséges 			

Függeszthető rács (118350)	Leírás	Instrukciók	Fizetési Kondíciók	Típus
	31.04 Sáv törött			
	31.05 Deformálódott <ul style="list-style-type: none"> ■ < 20 cm 			
	<ul style="list-style-type: none"> ■ Vagy > 20 cm 			
	31.06 Rögzítő kampó horog deformálódott <ul style="list-style-type: none"> ■ Ha lehetséges 			
	<ul style="list-style-type: none"> ■ Vagy ha nem lehetséges 			

Korlátoszlop (117325) Toldó (118296)	Leírás	Instrukciók	Fizetési Kondíciók	Típus
	31.07 Biztonsági horog <ul style="list-style-type: none"> ■ Hiányzik 	710418 (Biztonsági horog) 724567 (Feszítő hüvely)		
	<ul style="list-style-type: none"> ■ Vagy erő hatására sérült 	710418 (Biztonsági horog) 724567 (Feszítő hüvely)		
	31.08 Horpadások a profilban <ul style="list-style-type: none"> ■ Az éleket ez nem érinti (mélység max 3 mm) 			
	<ul style="list-style-type: none"> ■ Vagy érinti a éleket 			
	31.09 Lábdeszka rögzítő <ul style="list-style-type: none"> ■ Hiányzik 	115673 (Lábdeszka rögzítő)		
	<ul style="list-style-type: none"> ■ Vagy erő hatására sérült 	115673 (Lábdeszka rögzítő)		
	31.10 Korláttartó fül <ul style="list-style-type: none"> ■ Deformálódott 			
	<ul style="list-style-type: none"> ■ Hiányzik 			

Korlátozó tartó PDF (117323) PSF (117324)	Leírás	Instrukciók	Fizetési Kondíciók	Típus
---	--------	-------------	--------------------	-------

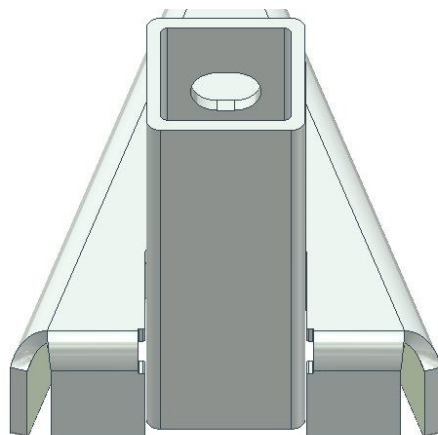

31.11 Csatlakozó deformálódott

- Korlátozó tartó behelyezhető
- Vagy nem behelyezhető a korlátozó tartóba



31.12 Alaplemez deformálódott

- Ha lehetséges
- Vagy ha nem lehetséges



Korlátozó tartó PUC (118660)	Leírás	Instrukciók	Fizetési Kondíciók	Típus
------------------------------	--------	-------------	--------------------	-------



31.13 Csatlakozó deformálódott

- Korlátozó tartó behelyezhető
- Vagy nem behelyezhető a korlátozó tartóba

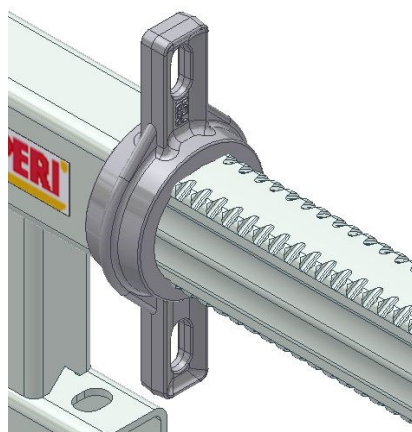

31.14 Állító anya











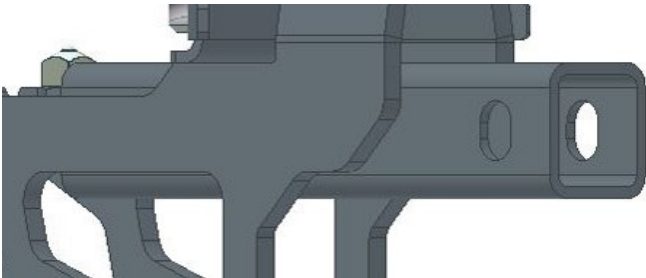





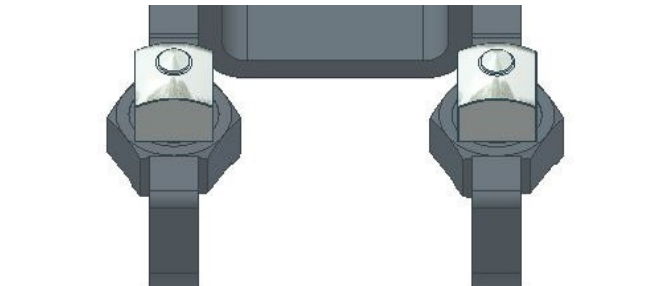

- Hiányzik
- Vagy erő hatására sérült

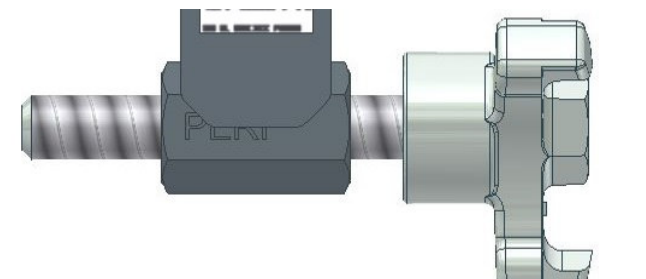

065048 (Szárnyas anya)

065048 (Szárnyas anya)



















Korlátozószlop tartó PSC (126330)	Leírás	Instrukciók	Fizetési Kondíciók	Típus		
	31.15 Csatlakozó deformálódott	<ul style="list-style-type: none"> ■ Korlátozószlop behelyezhető 				
	<ul style="list-style-type: none"> ■ Vagy nem behelyezhető a korlátozószlop 					
	31.16 Csapok	<ul style="list-style-type: none"> ■ Hiányzik 		112662 (Csap)		
	<ul style="list-style-type: none"> ■ Vagy erő hatására sérült 		112662 (Csap)			
	31.17 Szorítócsavar	<ul style="list-style-type: none"> ■ Hiányzik 		126337 (Szorítócsavar)		
	<ul style="list-style-type: none"> ■ Vagy erő hatására sérült 		126337 (Szorítócsavar)			

PERI Bérleti kritériumok

Ikonok



Ikon	Jelentés	Ikon	Jelentés	Ikon	Jelentés
	Nem OK — kiselejtezendő		Ügyfélnek leszámházandó		Optikai kár
	OK– marad a bérleti parkban		Nincs számlázás		Funkcionális sérülés
	Selejt anyag – biztonsági okokból az anyagot tilos kiadni		Anyagot levágni		Funkcionális sérülés — anyag kiadása nem engedélyezett
	Javítás az előírások szerint		Anyagot megjelölni		Statikai sérülés — anyag kiadása nem engedélyezett
	Hideg egyengetés — utána a varratokat és a környékét ellenőrzni kell		Sérült anyag cseréje		
	Javítás gazdaságosság függvényében		Hiányzó anyag cseréje		
	Megtisztítani az anyagot				