

# PERI Bérleti kritériumok

## PERI UP Homlokzati állvány Easy



### Kapcsolat

**PERI kft,**  
zsámozatok, állványzatok,  
mérnöki szolgáltatás

H-1181 Budapest  
Zádor u. 9.  
Tel.: +36-1-296-09-60  
www.peri.hu

Tartalom	Oldal	Változtatások	Dátum   ü	Oldal
Járótábla EDS	2	Új verzió	07/2021   Sz.L.	
Kombi tábla EDW	7			
Zárókeret elemei	10			
Létrafeljáró   Feljáró	13			
Átlós merevítő	18			
Korlátrúd	20			
Tartozékok	24			
Magyarázat	33			

# PERI Bérleti kritériumok

## PERI UP Homlokzati állvány Easy



### Járótábla EDS

Sorszám      Megnevezés      Cikkszám

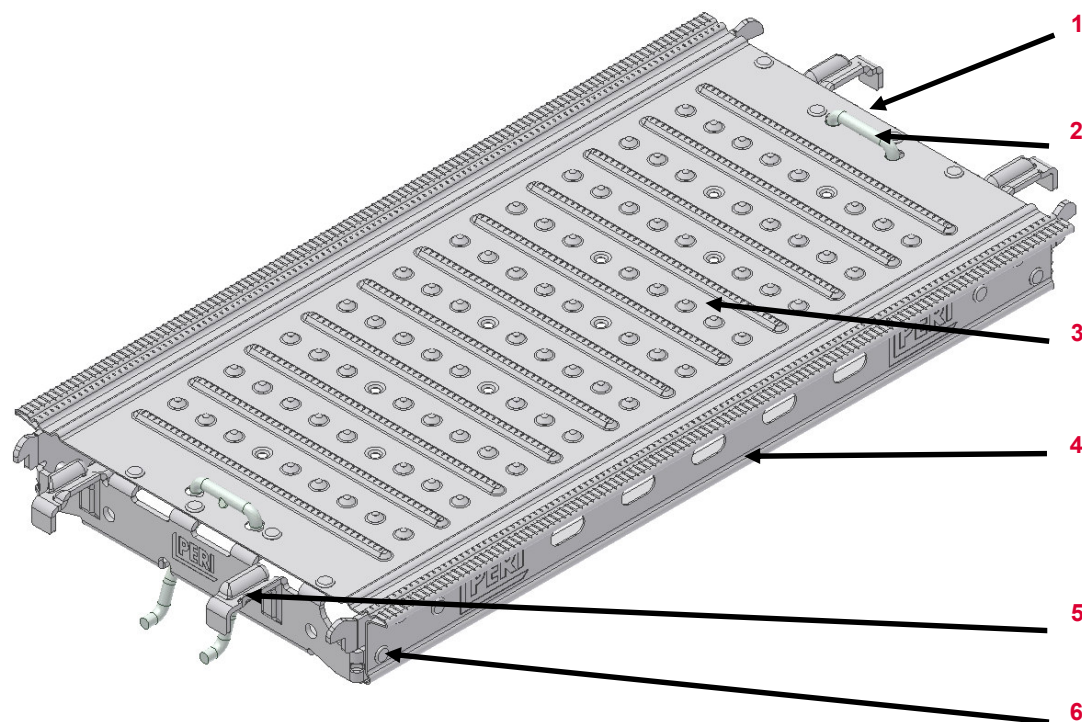

1	Akasztó EDS	129808
2	Biztosító fül	108716
3	Járófelület	
4	Oldalprofil	
5	Kapcsoló fül	108716
6	Szegecs 6,0x 10	723058

Megnevezés      Cikkszám

Járótábla EDS 33x67	130450
Járótábla EDS 33x100	130448
Járótábla EDS 33x150	130445
Járótábla EDS 33x200	130441
Járótábla EDS 33x250	130438
Járótábla EDS 33x300	129272

# PERI Bérleti kritériumok

## PERI UP Homlokzati állvány Easy











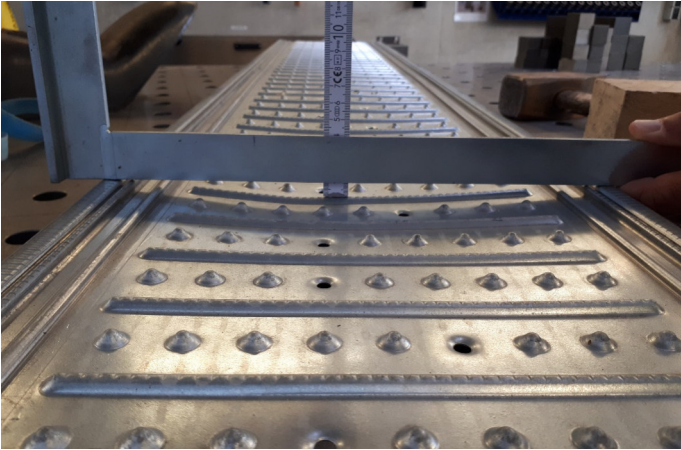







Járótábla EDS	Leírás	Instrukció	Fizetési kondíciók	Típus												
	<b>Profil éle hosszanti irányban elgörbült</b>															
	<ul style="list-style-type: none"> <li>A járótábla beillesztése lehetséges és nem sérült a TOX kapcsolat</li> </ul>															
	<ul style="list-style-type: none"> <li>Ha a járótábla beillesztése nem lehetséges</li> </ul>															
	<ul style="list-style-type: none"> <li>Sérült a TOX kapcsolat</li> </ul>															
	<b>Elgörbült az él a felső oldalon</b>															
	<ul style="list-style-type: none"> <li>&lt; megengedett görbület (L/250)</li> </ul>															
	<ul style="list-style-type: none"> <li>Ha &gt; mint a megengedett görbület</li> </ul>															
	<table border="1"> <thead> <tr> <th>Cikk</th> <th>Görbület mért.</th> </tr> </thead> <tbody> <tr> <td>EDS 67   100</td> <td>5 mm</td> </tr> <tr> <td>EDS 150</td> <td>6 mm</td> </tr> <tr> <td>EDS 200</td> <td>8 mm</td> </tr> <tr> <td>EDS 250</td> <td>10 mm</td> </tr> <tr> <td>EDS 300</td> <td>12 mm</td> </tr> </tbody> </table>	Cikk	Görbület mért.	EDS 67   100	5 mm	EDS 150	6 mm	EDS 200	8 mm	EDS 250	10 mm	EDS 300	12 mm			
Cikk	Görbület mért.															
EDS 67   100	5 mm															
EDS 150	6 mm															
EDS 200	8 mm															
EDS 250	10 mm															
EDS 300	12 mm															

# PERI Bérleti kritériumok

## PERI UP Homlokzati állvány Easy



Járótábla EDS	Leírás	Instrukció	Fizetési kondíciók	Típus
	<b>Görbület a járótáblán a rövid éllel párhuzamosan</b> <ul style="list-style-type: none"> <li>■ <math>\leq 15</math> mm (tegye a vonalzót/ derékszöget a járófelületre és kövesse a képet)</li> </ul>	 Csak egyszer javítható, második alkalommal selejt		
	<ul style="list-style-type: none"> <li>■ Ha <math>&gt; 15</math> mm</li> </ul>			
	<ul style="list-style-type: none"> <li>■ Ha a borda sérült</li> </ul>			
	<ul style="list-style-type: none"> <li>■ Ha <math>\leq 15</math> mm (második alkalommal)</li> </ul>			
	<b>Felület csavarodott</b>			

# PERI Bérleti kritériumok

## PERI UP Homlokzati állvány Easy



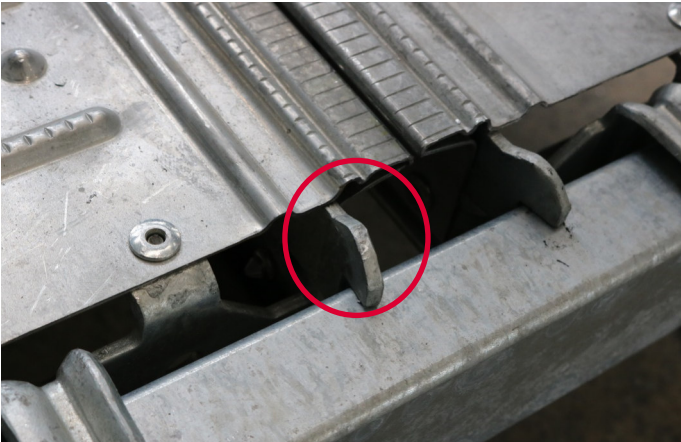





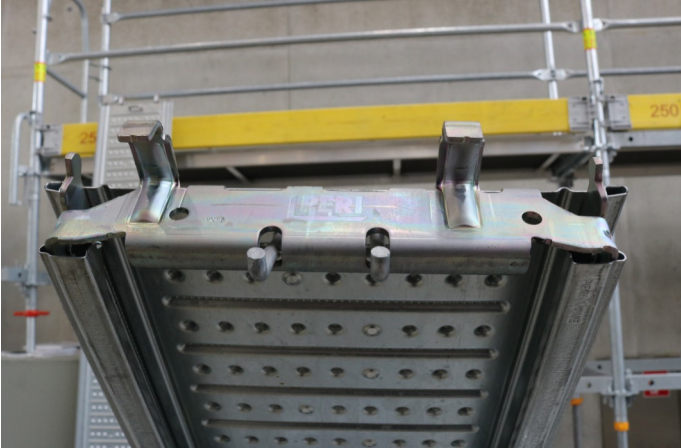

Járótábla EDS	Leírás	Instrukció	Fizetési kondíciók	Típus
	<b>Kapcsoló fül elgörbült</b>			
	<ul style="list-style-type: none"> <li>■ <math>\leq 5</math> mm</li> </ul>			
	<ul style="list-style-type: none"> <li>■ Ha törés, repedés van a fülön</li> </ul>			
	<ul style="list-style-type: none"> <li>■ Ha <math>&gt; 5</math> mm</li> </ul>			
	<b>Akaszókampó elgörbült</b>			
	<ul style="list-style-type: none"> <li>■ Törés nem látható az anyagon</li> </ul>			
	<ul style="list-style-type: none"> <li>■ A kampó repedt, eltört</li> </ul>			

# PERI Bérleti kritériumok

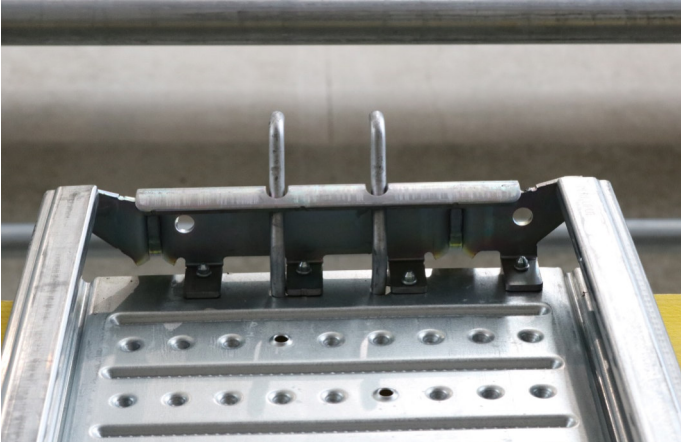
## PERI UP Homlokzati állvány Easy



Járótábla EDS	Leírás	Instrukció	Fizetési kondíciók	Típus
	Biztosító fül elgörbült			
	Biztosító fül elgörbült   használhatatlan			

# PERI Bérleti kritériumok

## PERI UP Homlokzati állvány Easy



### Kombi tábla EDW

Sorszám      Megnevezés      Cikkszám

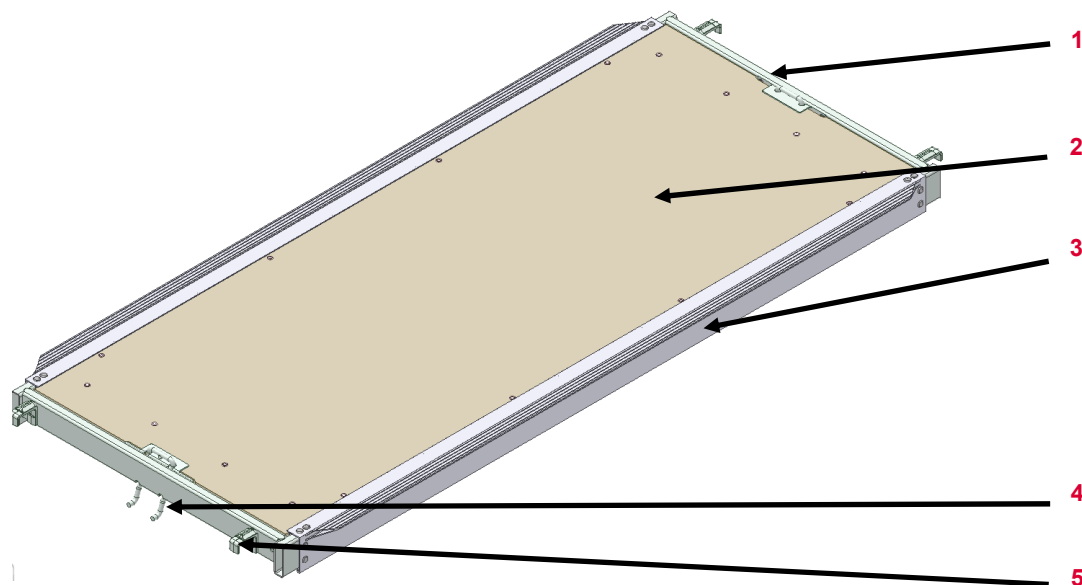

1	Kapcsoló elem kpl. EDW	130308
2	Járófelület	
3	Oldal profil	
4	Biztosító fül	
5	Kapcsoló fül	

Cikk	Cikkszám
Kombi tábla EDW 150	130321
Kombi tábla EDW 200	130317
Kombi tábla EDW 250	130313
Kombi tábla EDW 300	130309

# PERI Bérleti kritériumok

## PERI UP Homlokzati állvány Easy























Kombi tábla EDW	Leírás	Instrukció	Fizetési kondíciók	Típus
	<b>Élprofil elgörbült</b>			
	<ul style="list-style-type: none"> <li>■ A tábla beillesztése lehetséges</li> </ul>			
	<ul style="list-style-type: none"> <li>■ Ha a tábla beillesztése nem lehetséges</li> </ul>			
	<ul style="list-style-type: none"> <li>■ Ha az anyag megrepedt</li> </ul>			
	<b>Járófelület</b>			
	<ul style="list-style-type: none"> <li>■ Elhasználódás esetén</li> </ul>			
	<ul style="list-style-type: none"> <li>■ Erőbehatás következtében eltört / átszakadt rétegelt lemez</li> </ul>			



# PERI Bérleti kritériumok

## PERI UP Homlokzati állvány Easy



Kombi tábla EDW	Leírás	Instrukció	Fizetési kondíciók	Típus
	<b>Kapcsoló elem elhajlott</b> <ul style="list-style-type: none"> <li>■ <math>\leq 5</math> mm és nincs repedés az elemen</li> </ul>			
	<ul style="list-style-type: none"> <li>■ ha <math>&gt; 5</math> mm</li> <li>■ ha repedés van az elemen</li> </ul>			
	<b>Biztosító fül</b> <ul style="list-style-type: none"> <li>■ Deformálódott és egyengethető</li> </ul>			
	<ul style="list-style-type: none"> <li>■ Nem egyengethető vagy hiányzik</li> </ul>			
	<b>Hegesztés eltört a csatlakozásnál</b> <ul style="list-style-type: none"> <li>■ Borda deformáció miatt</li> </ul>			
	<ul style="list-style-type: none"> <li>■ Deformáció nélkül</li> </ul>			

# PERI Bérleti kritériumok

## PERI UP Homlokzati állvány Easy



Záró keret EVH | T-keret EVF | Alapkeret EVB | Cső EVR

Sorszám Megnevezés Cikkszám

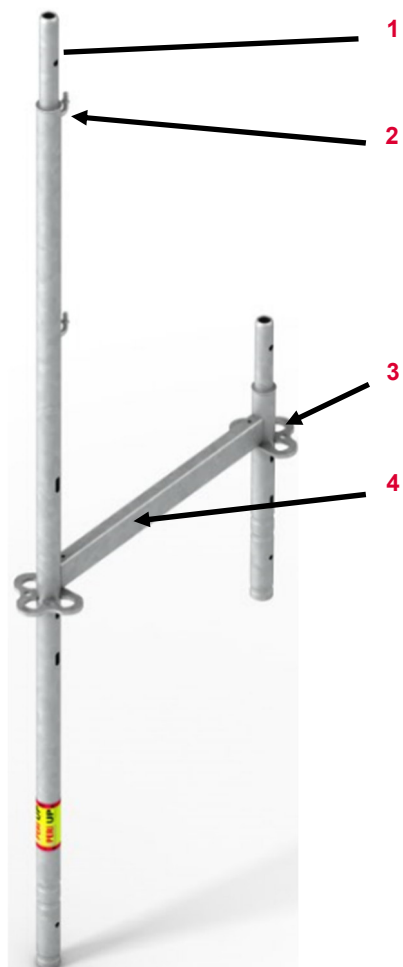













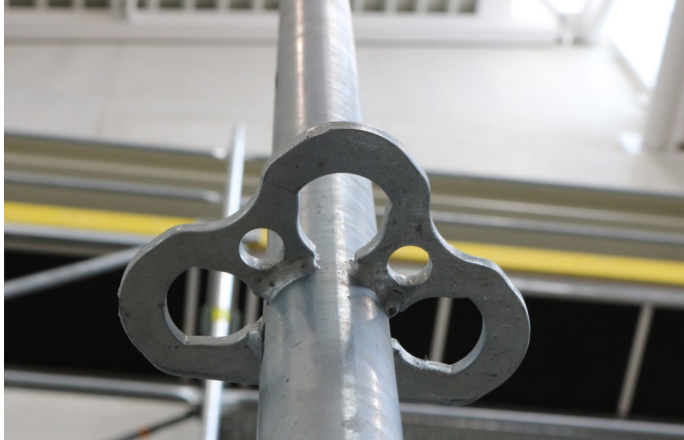

- |   |                     |
|---|---------------------|
| 1 | Csővég              |
| 2 | Védőkoriát akasztó  |
| 3 | 3/4 Rozetta         |
| 4 | Vízszintes szelvény |

Megnevezés	Cikkszám
Zárókeret EVH 67	129314
Zárókeret EVH 100	130804
T-keret EVF 67	130466
T-keret EVF 100	130860
Alapkeret EVB 67	130518
Alapkeret EVB 100	130858
Belső cső EVR 150	130481
Kiegészítő keret EVA 64/50	130522
Kiegészítő keret EVA 67/100	130526
Kiegészítő keret EVA 100/50	130854
Kiegészítő keret EVA 100/100	130856
Korlátozószlop EVP	130512
Konzol ECM 33	130378
Konzol ECM 67	130372
Konzol ECM 100	130365
Kieg. alaprúd EVS 124	130619
Kieg. rúd EVM 200	130621

# PERI Bérleti kritériumok

## PERI UP Homlokzati állvány Easy



















Keret elemek	Leírás	Instrukció	Fizetési kondíciók	Típus
	<p><b>Csővég   csatlakozás elgörbült</b></p> <ul style="list-style-type: none"> <li>■ minden látható deformáció</li> </ul>			
	<p><b>Rozetta deformálódása</b></p> <ul style="list-style-type: none"> <li>■ ha lehetséges</li> <li>■ ha a hegesztés eltört</li> <li>■ ha a görbület &gt; 20 mm</li> </ul>			
				
				

# PERI Bérleti kritériumok

## PERI UP Homlokzati állvány Easy



Keret elemei	Leírás	Instrukció	Fizetési kondíciók	Típus
	<b>Védőkoriát akasztó fül görbülése</b>			
	<ul style="list-style-type: none"> <li>■ ha lehetséges</li> </ul>			
	<ul style="list-style-type: none"> <li>■ anyag eltörése   hegesztési sérülés</li> </ul>			
	<b>Vízszintes szelvény horpadása</b>			
	<ul style="list-style-type: none"> <li>■ <math>\varnothing \leq 3</math> cm</li> </ul>			
	<ul style="list-style-type: none"> <li>■ ha eltört</li> </ul>			
	<ul style="list-style-type: none"> <li>■ ha a vízszintes szelvény éle érintett</li> </ul>			

# PERI Bérleti kritériumok

## PERI UP Homlokzati állvány Easy



### Látrafeljáró EAW | Feljáró EAW

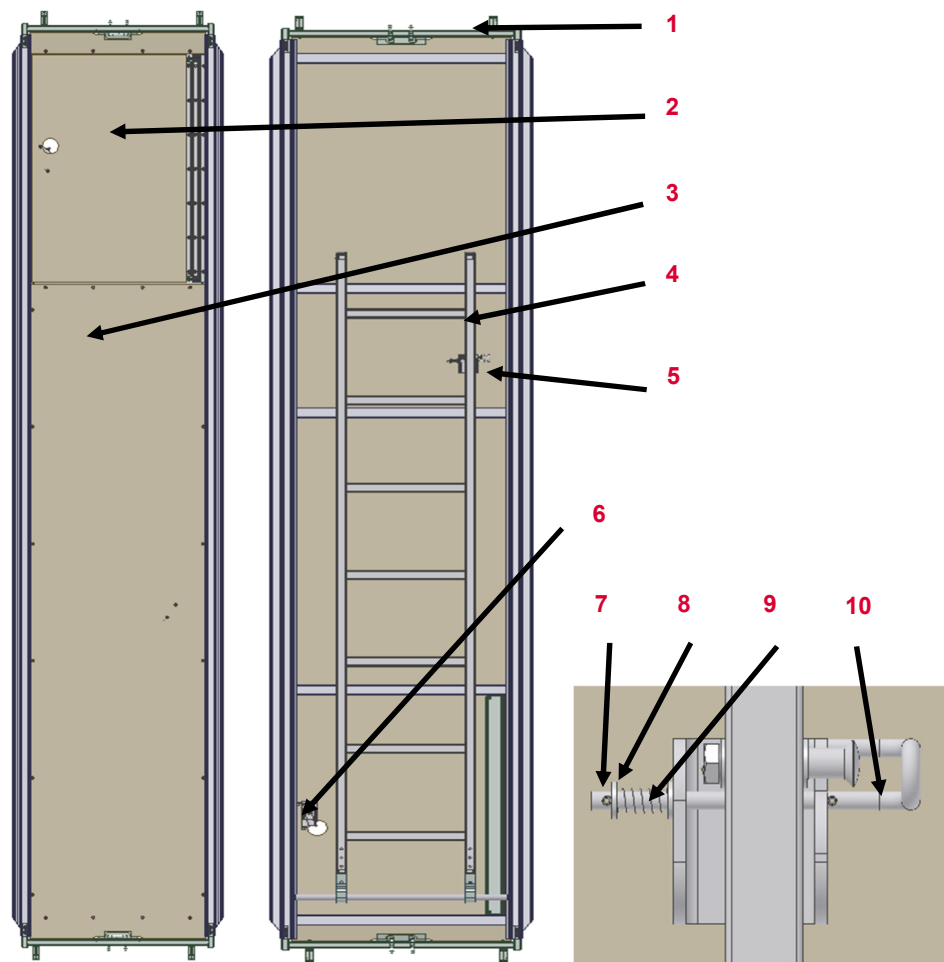











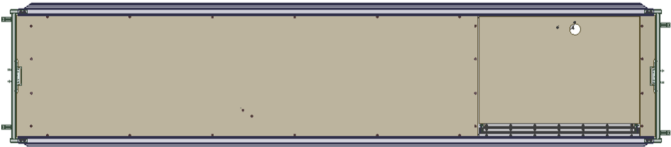

Sorszám	Megnevezés	Cikkszám
1	Kapcsoló elem kpl.	130308
2	Búvónyílás	130412
3	Rétegelt lemez járófelület	
4	Létra EAL	130419
5	Létra zár	130423
6	Zár UAL	115566
7	Hasított ék	130356
8	Alátét	721633
9	Rugó	130386
10	Biztosító fül	130422

Cikk	Cikkszám
létrafeljáró EAW-L 250	130431
létrafeljáró EAW-L 300	130425
feljáró tábla EAW 200	130426

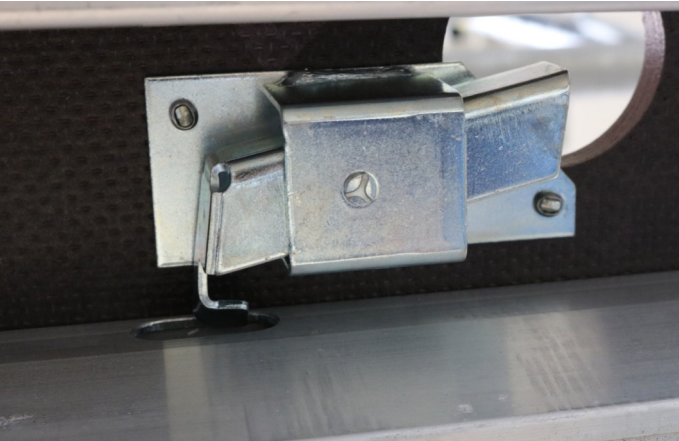
# PERI Bérleti kritériumok

## PERI UP Homlokzati állvány Easy























Létrafeljáró EAW   Feljáró EAW	Leírás	Instrukció	Fizetési kondíciók	Típus
	<p><b>lemez/nyílás</b></p> <ul style="list-style-type: none"> <li>■ elhasználódás</li> </ul>	 <p>130412 (Ajtó) 130407 (Rétegelt lemez EAW 300) 130427 (Rétegelt lemez EAW 250)</p>		
	<ul style="list-style-type: none"> <li>■ erőhatás miatti törés</li> </ul>	 <p>130412 (Ajtó) 130407 (Rétegelt lemez EAW 300) 130427 (Rétegelt lemez EAW 250)</p>		
	<p><b>Zár nem működik</b></p> <ul style="list-style-type: none"> <li>■ elhasználódás</li> </ul>			
	<ul style="list-style-type: none"> <li>■ sérülés erőhatás miatt</li> </ul>			

# PERI Bérleti kritériumok

## PERI UP Homlokzati állvány Easy

















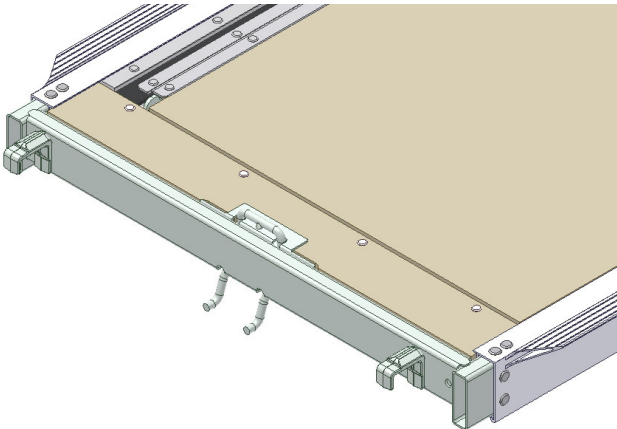

Létra feljáró EAW   Feljáró szint EAW	Leírás	Instrukció	Fizetési kondíciók	Típus
	<b>Létra zár</b> <ul style="list-style-type: none"> <li>■ Nem funkcionál elhasználódás miatt</li> </ul>			
	<ul style="list-style-type: none"> <li>■ Vagy erőszak miatt nem működik</li> </ul>			
	<ul style="list-style-type: none"> <li>■ Vagy hiányzó alkatrészek</li> </ul>			
	<b>Merevítő eldeformálódott</b> <ul style="list-style-type: none"> <li>■ Ha lehetséges</li> </ul>			
	<ul style="list-style-type: none"> <li>■ Vagy hegesztés megrepedt</li> </ul>			
	<ul style="list-style-type: none"> <li>■ Vagy csavarodott</li> </ul>			

# PERI Bérleti kritériumok

## PERI UP Homlokzati állvány Easy













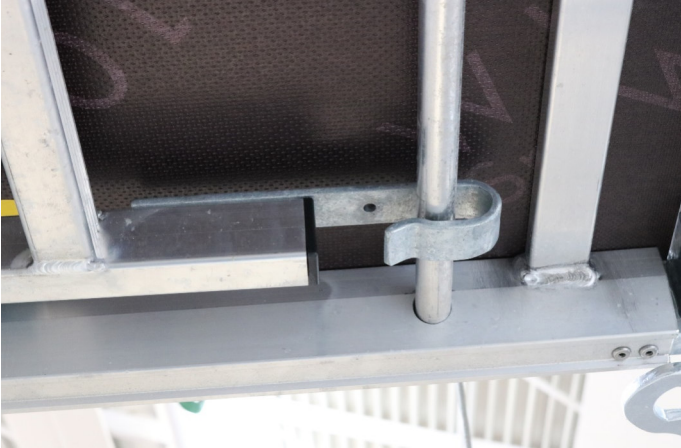







Létra feljáró EAW   Feljáró szint EAW	Leírás	Instrukció	Fizetési kondíciók	Típus
	<b>Kapcsoló fül deformálódott</b> <ul style="list-style-type: none"> <li>■ ≤ 5 mm</li> </ul>			
	<ul style="list-style-type: none"> <li>■ Vagy &gt; 5 mm</li> </ul>			
	<ul style="list-style-type: none"> <li>■ Vagy repedések a fülön</li> </ul>			
	<b>Biztosító fül elgörbült   nem funkcionál</b> <ul style="list-style-type: none"> <li>■ ha lehetséges</li> </ul>			
	<ul style="list-style-type: none"> <li>■ Ha nem lehetséges vagy hiányzik</li> </ul>			



# PERI Bérleti kritériumok

## PERI UP Homlokzati állvány Easy



Feljáró szint EAW	Leírás	Instrukció	Fizetési kondíciók	Típus
	<b>Létra akasztója elgörbült</b> <ul style="list-style-type: none"> <li>■ Ha lehetséges</li> </ul>			
	<ul style="list-style-type: none"> <li>■ Ha nem lehetséges</li> </ul>	 130417 (Akasztó fül Easy) 104280 (Szegecs 6,0x12)		
	<b>Létrafok deformálódott</b> <ul style="list-style-type: none"> <li>■ Nincs repedés a hegesztésben</li> </ul>	 		
	<ul style="list-style-type: none"> <li>■ Vagy repedéssel</li> </ul>			
	<ul style="list-style-type: none"> <li>■ Vagy csavarodás</li> </ul>			

# PERI Bérleti kritériumok

## PERI UP Homlokzati állvány Easy



### Átlós merevítő EBF

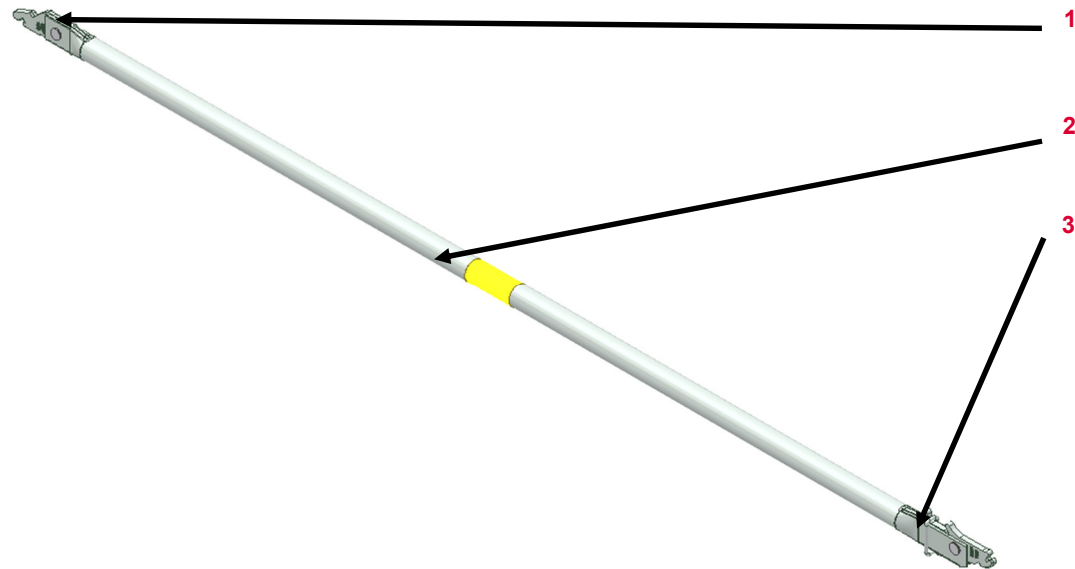

Sorszám	Megnevezés	Cikkszám
---------	------------	----------

- |   |                      |
|---|----------------------|
| 1 | Átlós fej alsó rész  |
| 2 | Cső                  |
| 3 | Átlós fej felső rész |

Cikk	Cikkszám
Átlós merevítő EBF 150/200	130162
Átlós merevítő EBF 200/200	130171
Átlós merevítő EBF 250/200	130180
Átlós merevítő EBF 300/200	130189

# PERI Bérleti kritériumok

## PERI UP Homlokzati állvány Easy



Átlós merevítő EBF	Leírás	Instrukció	Fizetési kondíciók	Típus
--------------------	--------	------------	--------------------	-------



Átlós fej nem funkcionál

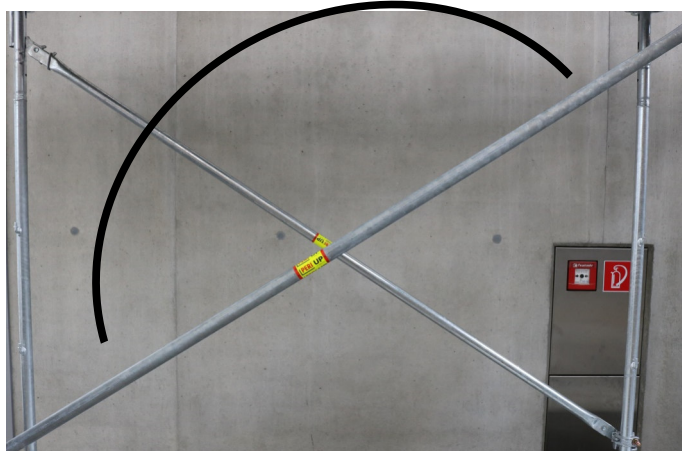

Átlós merevítő elgörbült

■  $\leq$  megengedett görbület (L/500)



■ Vagy  $>$  megeng. görbület (L/500)



Cikk	Megengedett görbület
Átlós merevítő EBF 150/200	4 mm
Átlós merevítő EBF 200/200	5 mm
Átlós merevítő EBF 250/200	6 mm
Átlós merevítő EBF 300/200	7 mm

# PERI Bérleti kritériumok

## PERI UP Homlokzati állvány Easy



### Korlátrúd EPG

Sorszám

Megnevezés

Cikkszám



1 Csatlakozó

2 Cső

**Cikk**

**Cikkszám**

Korlátrúd EPG 67

130191

Korlátrúd EPG 100

130193

Korlátrúd EPG 150

130195

Korlátrúd EPG 200

130197

Korlátrúd EPG 250

130199

Korlátrúd EPG 300

130201

# PERI Bérleti kritériumok

## PERI UP Homlokzati állvány Easy



Korlátrúd EPG	Leírás	Instrukció	Fizetési kondíciók	Típus
---------------	--------	------------	--------------------	-------



### Csatlakozó deformálódott

■ Ha lehetséges



■ Ha nem lehetséges



### Védőkorlát elgörbült

■ > megengedett görbület (L/250)



Megnevezés	Megengedett görbület
Korlátrúd EPG 67	3 mm
Korlátrúd EPG 100	4 mm
Korlátrúd EPG 150	6 mm
Korlátrúd EPG 200	8 mm
Korlátrúd EPG 250	10 mm
Korlátrúd EPG 300	12 mm

# PERI Bérleti kritériumok

## PERI UP Homlokzati állvány Easy



### Végkorlát EPF

Sorszám

Megnevezés

Cikkszám

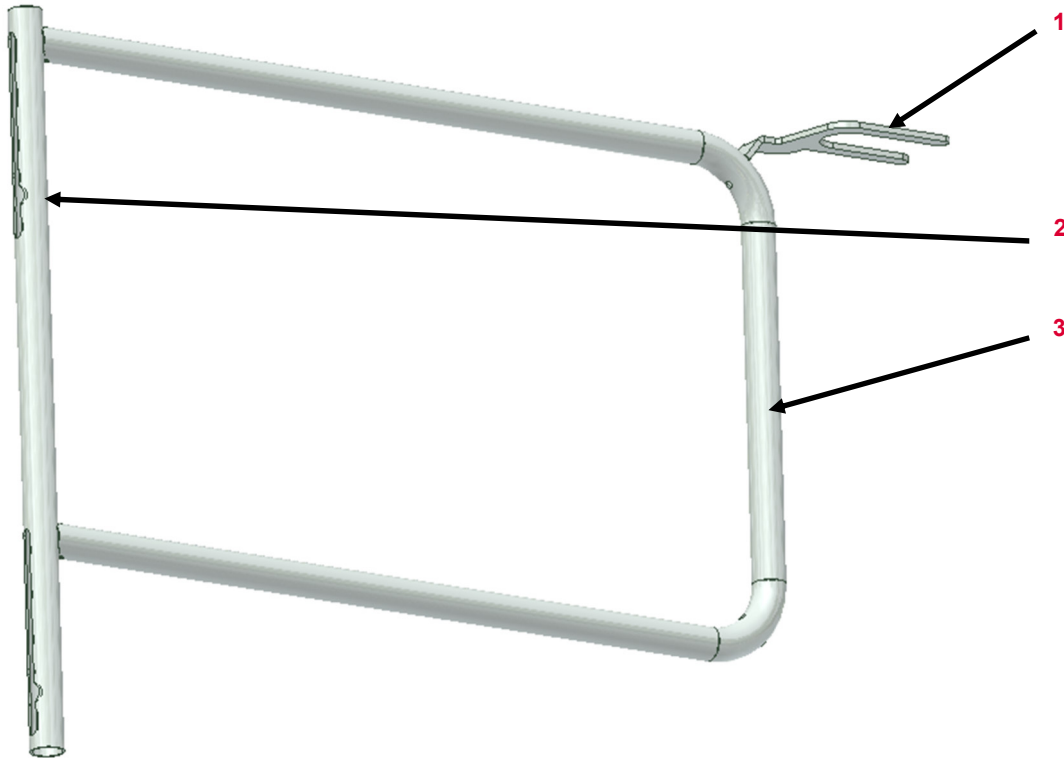

1

Villa

2

Cső















3

Keret

# PERI Bérleti kritériumok

## PERI UP Homlokzati állvány Easy



Végkorlát EPF	Leírás	Instrukció	Fizetési kondíciók	Típus
	<b>Villa deformálódott</b> <ul style="list-style-type: none"> <li>■ Ha lehetséges</li> </ul>			
	<ul style="list-style-type: none"> <li>■ Ha nem lehetséges</li> </ul>			
	<b>Cső roncsolódott</b> <ul style="list-style-type: none"> <li>■ Behelyezés lehetséges</li> </ul>			
	<ul style="list-style-type: none"> <li>■ Vagy nem lehetséges</li> </ul>			

# PERI Bérleti kritériumok

## PERI UP Homlokzati állvány Easy



















Védőtető konzol EPC (130385)	Leírás	Instrukció	Fizetési kondíciók	Típus
	<b>Csatlakozó csövek deformálódtak   roncsolódtak</b>  ■ Minden látható deformáció			
	<b>Horpadás a szelvényen</b>  ■ $\varnothing > 3$ cm			
	■ Vagy élek érintettek			

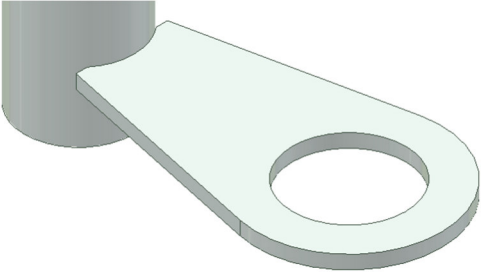

# PERI Bérleti kritériumok

## PERI UP Homlokzati állvány Easy



Védőfal korlát EPS (130532)	Leírás	Instrukció	Fizetési kondíciók	Típus
	<b>Korláttartó fül elgörbült</b> <ul style="list-style-type: none"> <li>■ Ha lehetséges</li> </ul>			
	<ul style="list-style-type: none"> <li>■ Ha nem lehetséges</li> </ul>			
	<b>Csap   csatlakozó deformálódott</b> <ul style="list-style-type: none"> <li>■ Minden látható deformáció</li> </ul>			
	<b>Csomópont lap deformálódott</b> <ul style="list-style-type: none"> <li>■ Ha lehetséges</li> </ul>			
	<ul style="list-style-type: none"> <li>■ Vagy ha nem lehetséges</li> </ul>			

# PERI Bérleti kritériumok

## PERI UP Homlokzati állvány Easy



Easy kikötőrúd bilincs EWC (130964)	Leírás	Instrukció	Fizetési kondíciók	Típus
-------------------------------------	--------	------------	--------------------	-------

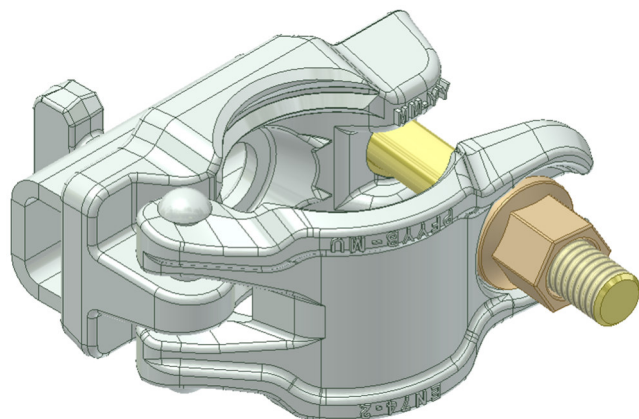

### Csukló nem funkcionál

- Kopott
- Vagy erő miatt megsérült

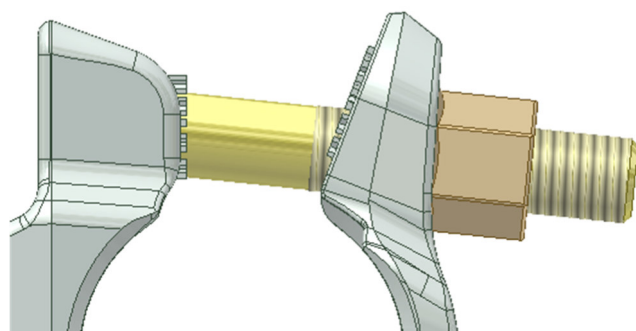

### Kalapácsfejű csavar | anya

- Hiányzik
- Vagy sérült



131316 (Kalapácsfejű csavar)  
710340 (Anya)

















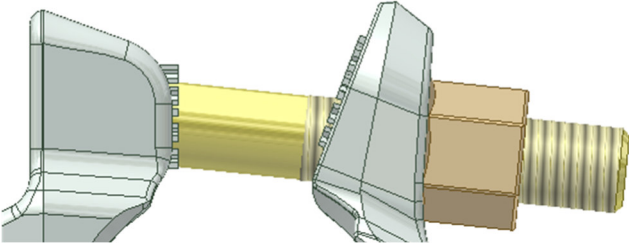

131316 (Kalapácsfejű csavar)  
710340 (Anya)

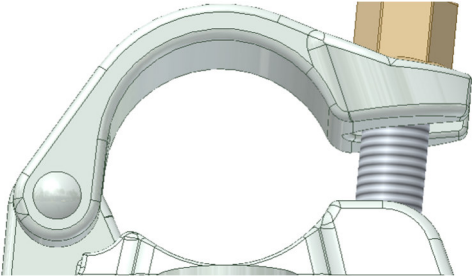

# PERI Bérleti kritériumok

## PERI UP Homlokzati állvány Easy



Korláttartó bilincs EPR (130434)	Leírás	Instrukció	Fizetési kondíciók	Típus
	<b>Korláttartó fül elgörbült</b> <ul style="list-style-type: none"> <li>■ Ha lehetséges</li> </ul>			
	<ul style="list-style-type: none"> <li>■ Vagy ha nem lehetséges</li> </ul>			
	<b>Kalapácsfejű csavar   Anya</b> <ul style="list-style-type: none"> <li>■ Hiányzik</li> </ul>		117475 (kalapácsfejű csavar) 710340 (anya)	 
	<ul style="list-style-type: none"> <li>■ Vagy sérült</li> </ul>		117475 (kalapácsfejű csavar) 710340 (anya)	 
	<b>Csukló nem funkcionál</b> <ul style="list-style-type: none"> <li>■ Kopott</li> </ul>			
	<ul style="list-style-type: none"> <li>■ Vagy erő miatt sérült</li> </ul>			

# PERI Bérleti kritériumok

## PERI UP Homlokzati állvány Easy



Időjárás védelem (133753   133742   133745)	Leírás	Instrukció	Fizetési kondíciók	Típus
---	--------	------------	--------------------	-------

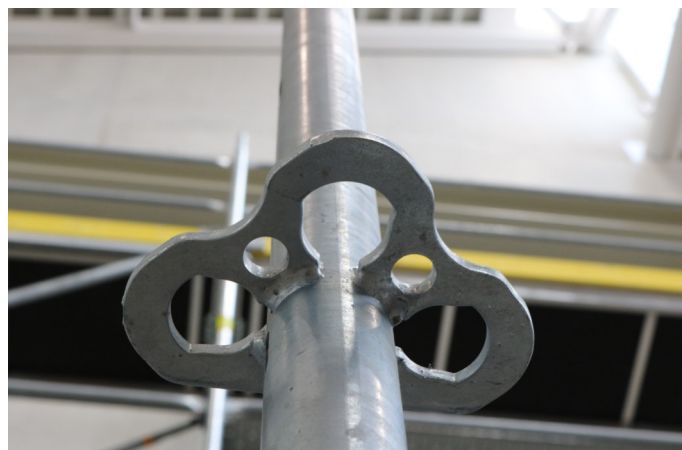

### Rozetta deformálódott

- Ha lehetséges
- Vagy hegesztés / anyag repedt
- Vagy görbület > 20 mm

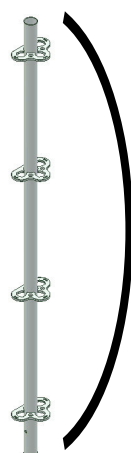

### Teljes hosszban görbült

- $\leq 1/500$
- Vagy  $> 1/500$



# PERI Bérleti kritériumok

## PERI UP Homlokzati állvány Easy

















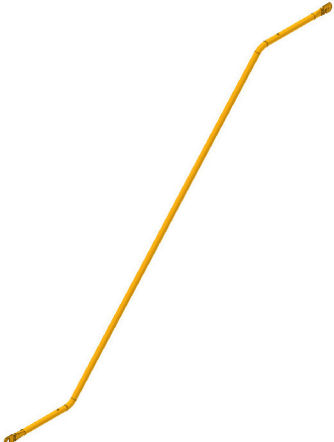

Kuplung EVW (133757)	Leírás	Instrukció	Fizetési kondíciók	Típus
	<b>Lemezek elgörbültek</b>			
	<ul style="list-style-type: none"> <li>■ Ha lehetséges</li> </ul>			
	<ul style="list-style-type: none"> <li>■ Ha nem lehetséges</li> </ul>			
	<b>Kalapácsfejű csavar   anya hiányzik</b>			
		131316 (kalapácsfejű csavar) 710340 (anya)		

# PERI Bérleti kritériumok

## PERI UP Homlokzati állvány Easy















Lépcsőkoriát EAG (124558   124561)	Leírás	Instrukció	Fizetési kondíciók	Típus
	<b>Csatlakozó deformálódott</b> <ul style="list-style-type: none"> <li>■ Ha lehetséges</li> </ul>			
	<ul style="list-style-type: none"> <li>■ Ha nem lehetséges</li> </ul>			
	<ul style="list-style-type: none"> <li>■ Vagy repedés az anyagban</li> </ul>			
	<b>Korlát elgörbült</b> <ul style="list-style-type: none"> <li>■ <math>\leq 1/500</math></li> </ul>			
	<ul style="list-style-type: none"> <li>■ Vagy <math>&gt; 1/500</math></li> </ul>			

# PERI Bérleti kritériumok

## PERI UP Homlokzati állvány Easy



Korlátkiegészítés UAH-2 (133543)	Leírás	Instrukció	Fizetési kondíciók	Típus
	<b>Villa deformálódott</b> <ul style="list-style-type: none"> <li>■ Ha lehetséges</li> </ul>			
	<ul style="list-style-type: none"> <li>■ Vagy ha nem lehetséges</li> </ul>			
	<b>Retesz   Csavar   Anya</b> <ul style="list-style-type: none"> <li>■ Hiányzik</li> </ul>			
	<ul style="list-style-type: none"> <li>■ Vagy erő miatt sérült</li> </ul>		133531 (retesz) 123978 (csavar) 711071 (anya)	

# PERI Bérleti kritériumok

## PERI UP Homlokzati állvány Easy



















UP Biztosító dugasz (133705)	Leírás	Instrukció	Fizetési kondíciók	Típus
	Deformálódott			



# PERI Bérleti kritériumok

## Magyarázat



Ikon	Jelentés	Ikon	Jelentés	Ikon	Jelentés
	Nem Ok– Selejtezendő		Ügyfélnek számlázandó		Optikai kár
	OK– marad a bérleti parkban		Nincs számlázás		Funkcionális sérülés
	Selejt anyag– biztonsági okokból az anyagot tilos kiadni		Anyagot levágni		Funkcionális sérülés— anyag kiadása nem engedélyezett
	Javítás az előírások szerint		Anyagot megjelölni		Statikai sérülés— anyag kiadása nem engedélyezett
	Hideg egyengetés– utána a varratokat és a környékét ellenőrizni kell		Sérült anyag cseréje		
	Javítás gazdaságosság függvényében		Hiányzó anyag pótlása		
	Megtisztítani az anyagot				