

PERI Bérleti kritériumok

Faltámaszok



Kapcsolat

PERI kft,
zsaluzatok, állványzatok,
mérnöki szolgáltatás

H-1181 Budapest
Zádor u. 9.
Tel.: +36-1-296-09-60
www.peri.hu

Tartalom	Oldal	Változás	Dátum ü	oldal
Faltámaszok RS	2	Új verzió	07/2021 O.L.	
Faltámasz RS 1400	7			
Faltámasz RSS	12			
Faltámasz merevítő AV	16			
Faltámasz talp	19			
Támaszkapcsolók	21			
TRIO Támaszkapcsoló	27			
Egyéb Támaszkapcsolók	28			
Magyarázat	36			

PERI Bérleti kritériumok

Faltámaszok



Faltámasz RS	Sorsz.	Megnevezés	Cikkszám
--------------	--------	------------	----------

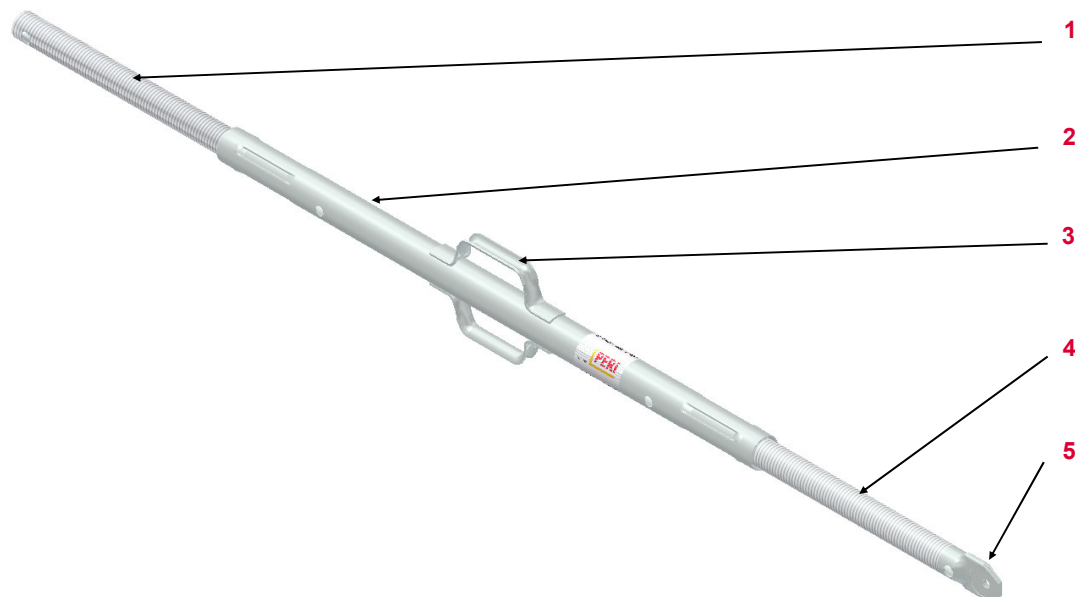

- 1 Orsó bal
- 2 Külső cső
- 3 Kezelő fül
- 4 Orsó jobb
- 5 Csatlakozó

Megnevezés	Cikkszám
Faltámasz RS 210	117466
Faltámasz RS 260	118238
Faltámasz RS 300	117467
Faltámasz RS 450	117468
Faltámasz RS 650	117469
Faltámasz RS 1000	028990

PERI Bérleti kritériumok

Faltámaszok

















Faltámasz RS	Leírás	Instrukció	Fizetési kondíció	Típus
	Kezelő fül			
	■ Deformálódott		088244	
	■ Vagy használhatatlan			
	■ Vagy repedés a hegesztésben			
	Orsó			
	■ Erősen szennyeződött	Használjon kenőzsírt		
	■ Vagy deformálódott		Lásd 6.o.	
	■ Vagy használhatatlan		Lásd 6.o.	

PERI Bérleti kritériumok

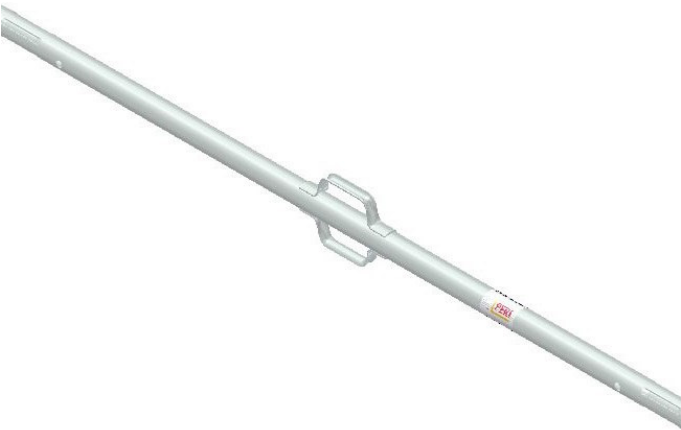
Faltámaszok























Faltámasz RS	Leírás	Instrukció	Fizetési kondíció	Típus									
	Csatlakozó deformálódott <ul style="list-style-type: none"> ■ Ha lehetséges 		 088244										
	<ul style="list-style-type: none"> ■ Ha nem lehetséges 		 Lásd 6.o.										
	<ul style="list-style-type: none"> ■ Vagy repedés a profilban 		 Lásd 6.o.										
	Külső cső <ul style="list-style-type: none"> ■ Horpadt > Ø 3 cm ■ Vagy nem működik funkcionálisan ■ Vagy deformálódott > (L/500) 												
	<table border="1"> <thead> <tr> <th>Hosszúság</th> <th>Megengedett hajlás</th> </tr> </thead> <tbody> <tr> <td>RS 210, 260; 300</td> <td>4,0mm</td> </tr> <tr> <td>RS 450</td> <td>5,0 mm</td> </tr> <tr> <td>RS 650</td> <td>7,5 mm</td> </tr> <tr> <td>RS 1000</td> <td>12,0 mm</td> </tr> </tbody> </table>	Hosszúság	Megengedett hajlás	RS 210, 260; 300	4,0mm	RS 450	5,0 mm	RS 650	7,5 mm	RS 1000	12,0 mm		
Hosszúság	Megengedett hajlás												
RS 210, 260; 300	4,0mm												
RS 450	5,0 mm												
RS 650	7,5 mm												
RS 1000	12,0 mm												

PERI Bérleti kritériumok

Faltámaszok



Faltámasz RS	Leírás	Instrukció	Fizetési kondíció	Típus
	Szegecs Hasított ék <ul style="list-style-type: none"> ■ Hiányzik 			
	<ul style="list-style-type: none"> ■ Kopott (végállás funkció nem működik) 			
	<ul style="list-style-type: none"> ■ Vagy erőhatás miatt sérült 			
	Orsó vége deformálódott <ul style="list-style-type: none"> ■ Ha lehetséges 			
	<ul style="list-style-type: none"> ■ Ha nem lehetséges 			
	<ul style="list-style-type: none"> ■ Vagy repedések vannak az anyagban 			

PERI Bérleti Kritériumok

Faltámaszok



Cikk	Pótalkatrész cikkszáma	Szolgáltatás cikkszáma
Csere orsó 643	117655	088143
Csere orsó 705,5	117650	088144
Csere orsó 400	117687	088139
Csere orsó 462	117682	088142

PERI Bérleti kritériumok

Faltámaszok



Faltámasz RS 1400 (103800)	Sorsz.	Megnevezés	Cikkszám
----------------------------	--------	------------	----------

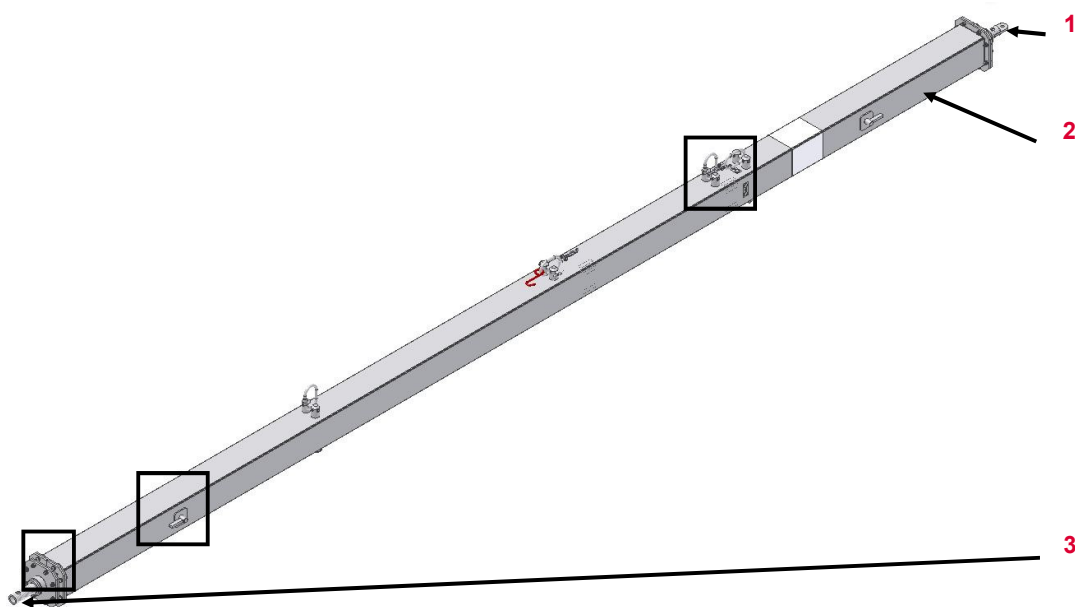



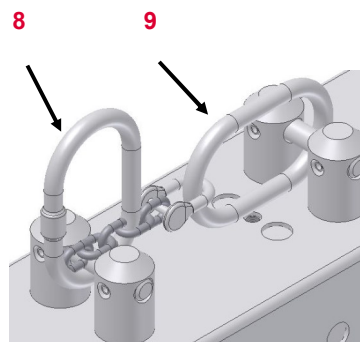
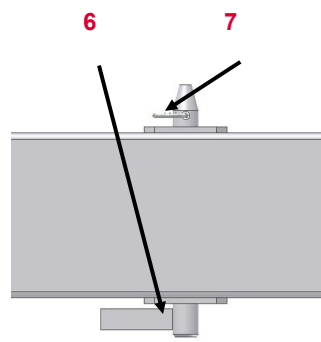
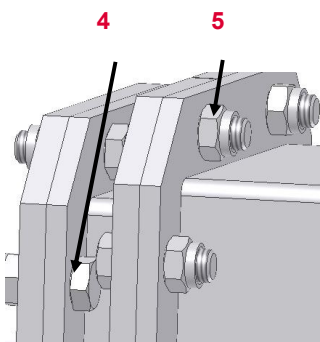







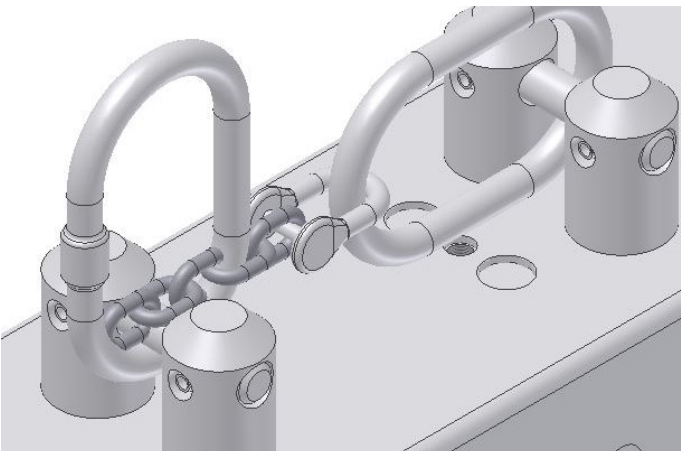

1	Fejorsó	104242
2	Külső cső	
3	Talporsó	104238
4	Hatl. csavar M 12x35	780156
5	Anyá M 12	710381
6	Csap	104224
7	Sasszeg 4/1	018060
8	Függesztő szem	710671
9	Lánc RS 1400	104244

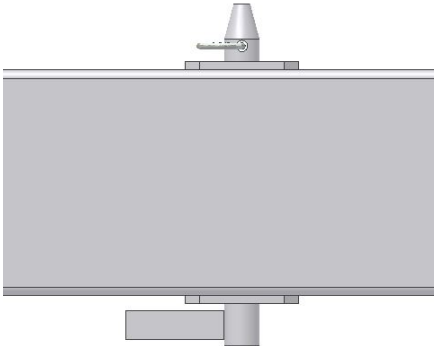

PERI Bérleti kritériumok

Faltámaszok



Faltámasz RS 1400	Leírás	Instrukció	Fizetési kondíció	Típus
	Lánc			
	■ Hiányzik	 104244 (Lánc) 722441 (Függesztő szem)	 088134	
	■ Vagy használhatatlan	 104244 (Lánc) 722441 (Függesztő szem)	 088134	
	<hr/>			
	Csap			
	■ Hiányzik	 104224 (Csap) 018060 (Sasszeg)	 088178	
	■ Vagy használhatatlan	 104224 (Csap) 018060 (Sasszeg)	 088178	

PERI Bérleti kritériumok

Faltámaszok



Faltámasz RS 1400	Leírás	Instrukció	Fizetési kondíció	Típus
-------------------	--------	------------	-------------------	-------

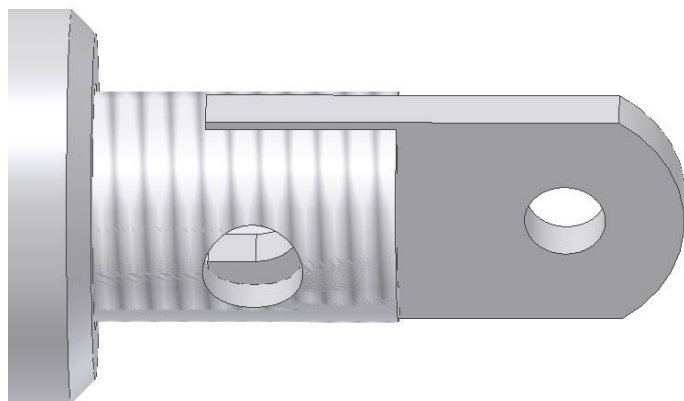

Orsó deformálódott

■ Ha lehetséges



088244



■ Ha nem lehetséges



104243 (Fejorsó egység)



088137



Orsó

■ Erősen szennyezett



Használjon kenőzsírt



■ Vagy ha nem mozgatható



104243 (Fejorsó egység)
104239 (Talporsó)



088137
088126



■ Vagy deformálódott



104243 (Fejorsó egység)
104239 (Talporsó)













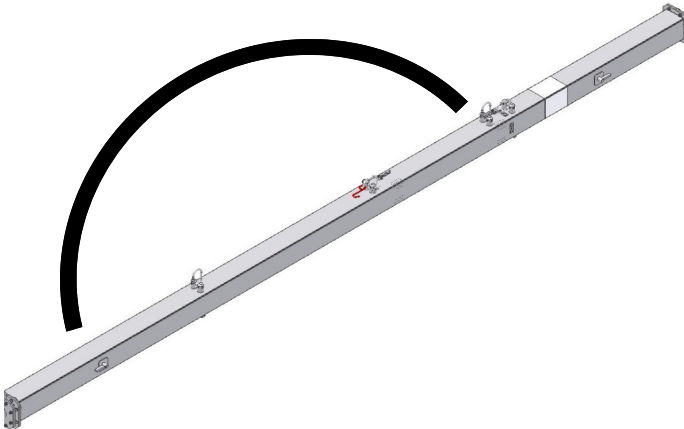



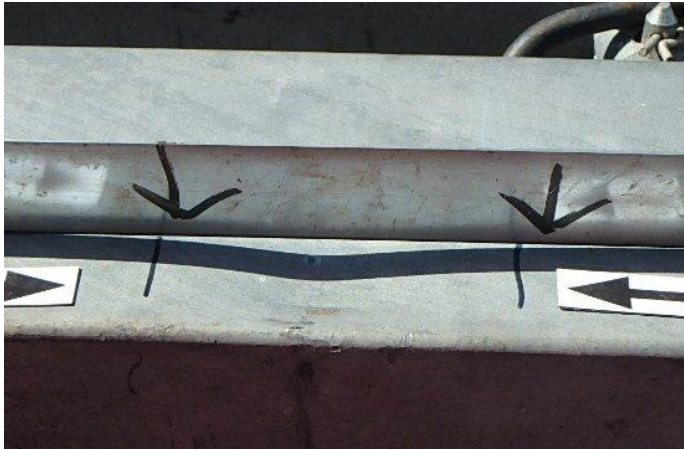

088137
088126



PERI Bérleti kritériumok

Faltámaszok











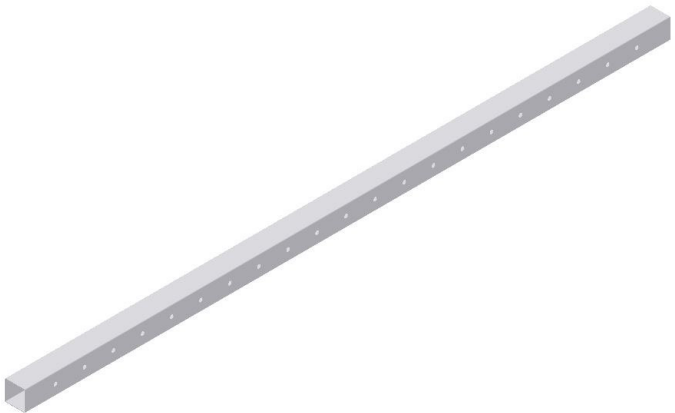

Faltámasz RS 1400	Leírás	Instrukció	Fizetési kondíció	Típus
	Külső cső elgörbült <ul style="list-style-type: none"> ■ Ha működik a teszkóp cső, és a sérülés ≤ 1 cm 			
	<ul style="list-style-type: none"> ■ Ha nem működik, vagy a sérülés > 1 cm 			
	Horpadás a külső csövön <ul style="list-style-type: none"> ■ Ha működik a teszkóp cső, és a sérülés ≤ 5 mm 			
	<ul style="list-style-type: none"> ■ Ha nem működik, vagy a sérülés > 5 mm 			
	<ul style="list-style-type: none"> ■ Vagy az élek érintettek a sérülésben (horpadás, megtört, vágás) 			

PERI Bérleti kritériumok

Faltámaszok



Faltámasz RS 1400	Leírás	Instrukció	Fizetési kondíció	Típus
	Teleszkóp cső <ul style="list-style-type: none"> Nem működik funkcionálisan 	 104214 (Teleszkóp cső jobb) 104251 (Teleszkóp cső bal)	 088149 088148	
	Lyukak deformálódtak <ul style="list-style-type: none"> Ha a csap behelyezhető Vagy ha nem lehetséges Vagy repedések vannak rajta 	  	104214 (Teleszkópikus cső jobb) 104251 (Teleszkópikus cső bal)	   088149 088148

PERI Bérleti kritériumok

Faltámaszok



Faltámasz RSS	Sorsz.	Megnevezés	Cikkszám
---------------	--------	------------	----------

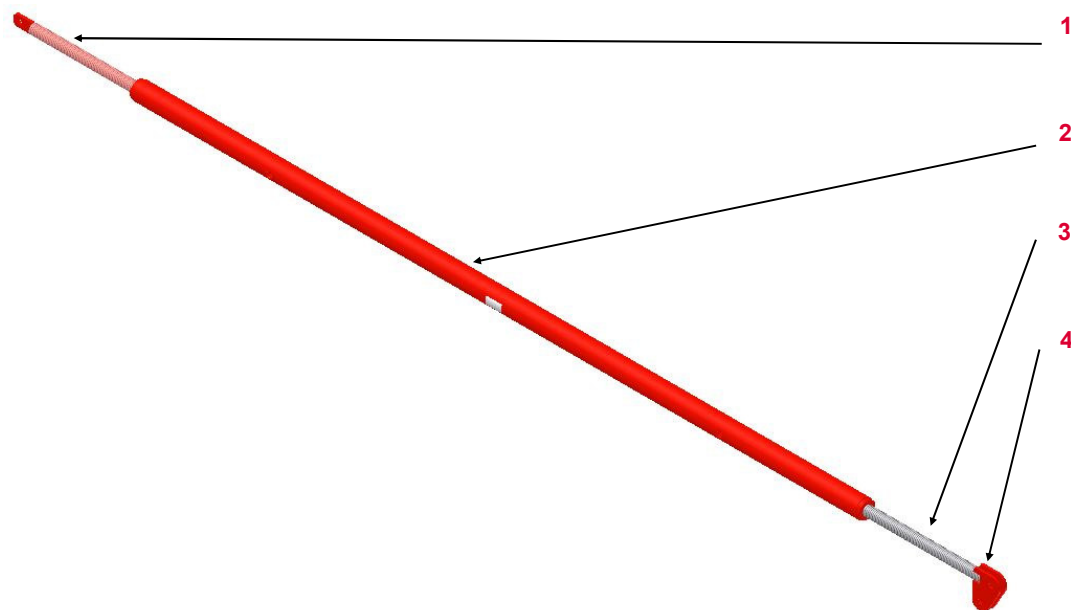

1	Orsó bal
2	Külső cső
3	Orsó jobb
4	Fej

Megnevezés	Cikkszám
Faltámasz RSS	028010
Faltámasz RSS	028020
Faltámasz RSS	028030

PERI Bérleti kritériumok

Faltámaszok



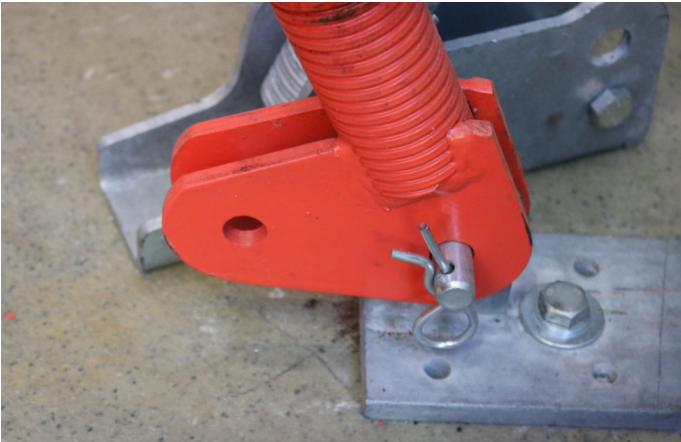







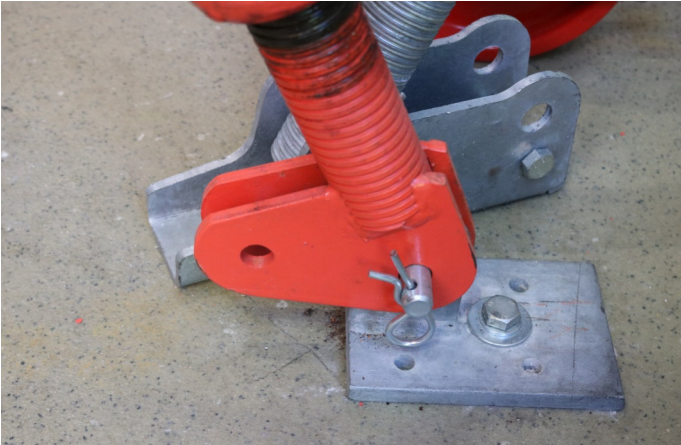







Faltámasz RSS	Leírás	Instrukció	Fizetési kondíció	Típus
	Csatlakozó fül hajlott			
	■ ≤ 5 mm		088244	
	■ Vagy > 5 mm			
	■ Vagy repedés a hegesztésben			
	Fej hajlott			
	■ Ha lehetséges (Kapcsolódás létrehozható)		088244	
	■ Vagy nem lehetséges			

PERI Bérleti kritériumok

Faltámaszok









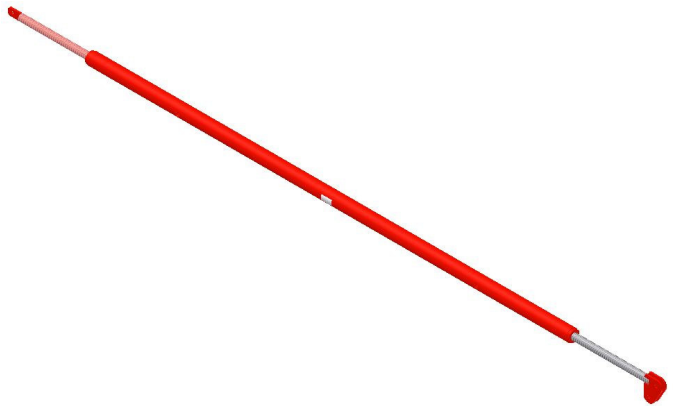

Faltámasz RSS	Leírás	Instrukció	Fizetési kondíció	Típus
	Orsó			
	■ Szennyezett	 Használjon kenőzsírt		
	■ Vagy hajlott > 5 mm			
	■ Vagy használhatatlan			
	Kezelő fül (RSS III)			
	■ Hajlott			
	■ Vagy repedt			

PERI Bérleti kritériumok

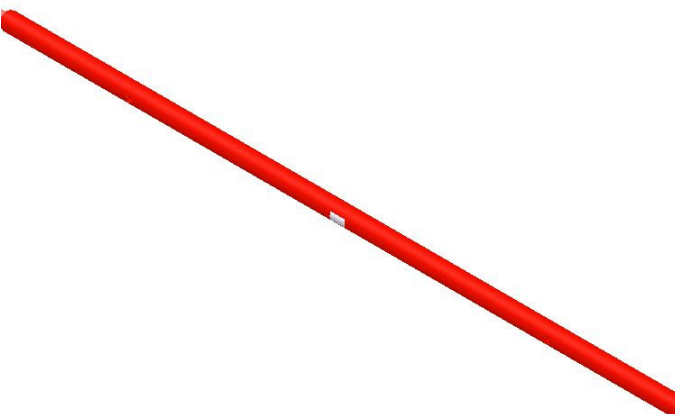
Faltámaszok



Faltámasz RSS	Leírás	Instrukció	Fizetési kondíció	Típus
	Elgöbült ■ > 1 cm			
	Horpadt Törés ■ t > 5 mm			

PERI Bérleti kritériumok

Faltámaszok



Merevítő AV	Sorsz.	Megnevezés	Cikkszám
-------------	--------	------------	----------

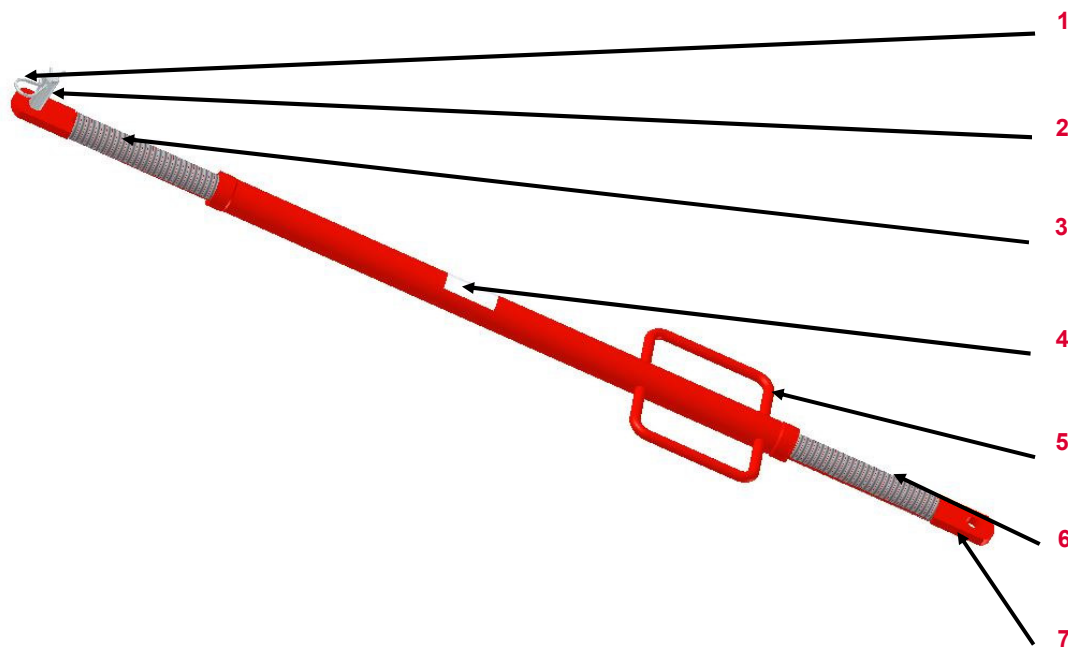



1	Sasszeg 4/1	018060
2	Csap Ø 16x42 mm	027170
3	Orsó jobb	
4	Külső cső	
5	Kezelő fül	
6	Orsó bal	
7	Csatlakozó fül	

Megnevezés	Cikkszám
Merevítő AV 82	057087
Merevítő AV 111	057088
Merevítő AV 140	028110
Merevítő AV 210	108135
Merevítő AV RSS III	028120

PERI Bérleti kritériumok

Faltámaszok

















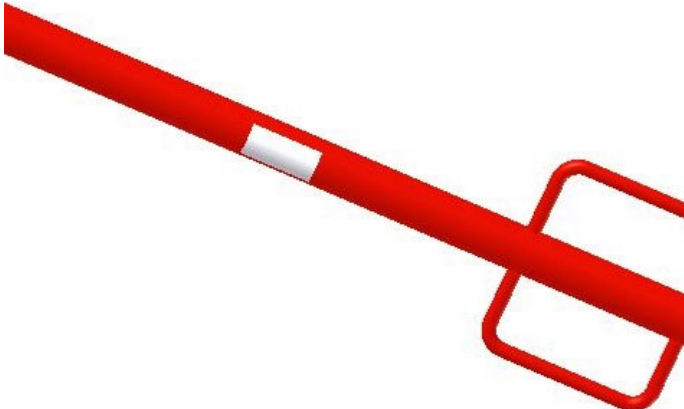

Merevítő AV	Leírás	Instrukció	Fizetési kondíció	Típus
	Csatlakozó fül hajlott			
	■ ≤ 5 mm		088244	
	■ Vagy > 5 mm			
■ Vagy repedés a hegesztésben				
	Orsó			
	■ Erősen szennyezett	Használjon kenőzsírt		
	■ Vagy hajlott > 5 mm			
■ Vagy használhatatlan				

PERI Bérleti kritériumok

Faltámaszok



Merevítő AV	Leírás	Instrukció	Fizetési kondíció	Típus
	Külső cső deformálódott <ul style="list-style-type: none"> ■ ≤ 5 mm 			
	<ul style="list-style-type: none"> ■ Vagy > 5 mm 			
	Horpadás a külső csövön <ul style="list-style-type: none"> ■ $t \leq 5$ mm 			
	<ul style="list-style-type: none"> ■ Vagy $t > 5$ mm 			
	<ul style="list-style-type: none"> ■ Vagy törés 			

PERI Bérleti kritériumok

Faltámaszok



Faltámasz talp-2 RSS (106000)	Sorsz.	Megnevezés	Cikkszám
-------------------------------	--------	------------	----------

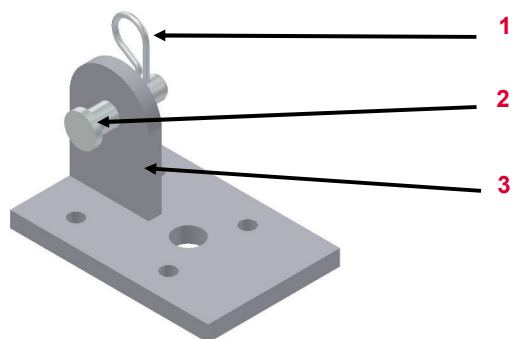

1	Sasszeg 4/1	018060
2	Csap Ø 16 x 42	027170
3	Csatlakozó fül	

Sérülés	Leírás	Instrukció	Fizetési kondíció	Típus
---------	--------	------------	-------------------	-------



Repedés a hegesztésben

- Sérüléssel
- Vagy sérülés nélkül



Csatlakozó fül hajlott

- $\leq 5^\circ$
- Vagy $> 5^\circ$

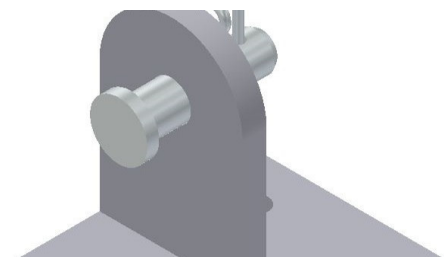

PERI Bérleti kritériumok

Faltámaszok



Faltámasz talp-2 (117343)	Sorsz.	Megnevezés	Cikkszám
	1	Csap Ø 20 x 140	105400
	2	Hatl. csavar M 12 x 80	710220
	3	Anya M 12	710381
	4	Alap lemez	
	5	Sasszeg 4/1	018060

Sérülés	Leírás	Instrukció	Fizetési kondíció	Típus
	Alaplemez deformálódott <ul style="list-style-type: none"> ■ Ha lehetséges ■ Vagy ha nem lehetséges 	 	088244 	
	Csap Sasszeg Hatl. Csavar / anya hiányzik			

PERI Bérleti kritériumok

Faltámaszok



Vario támaszkapcsoló GT 24 (028050)

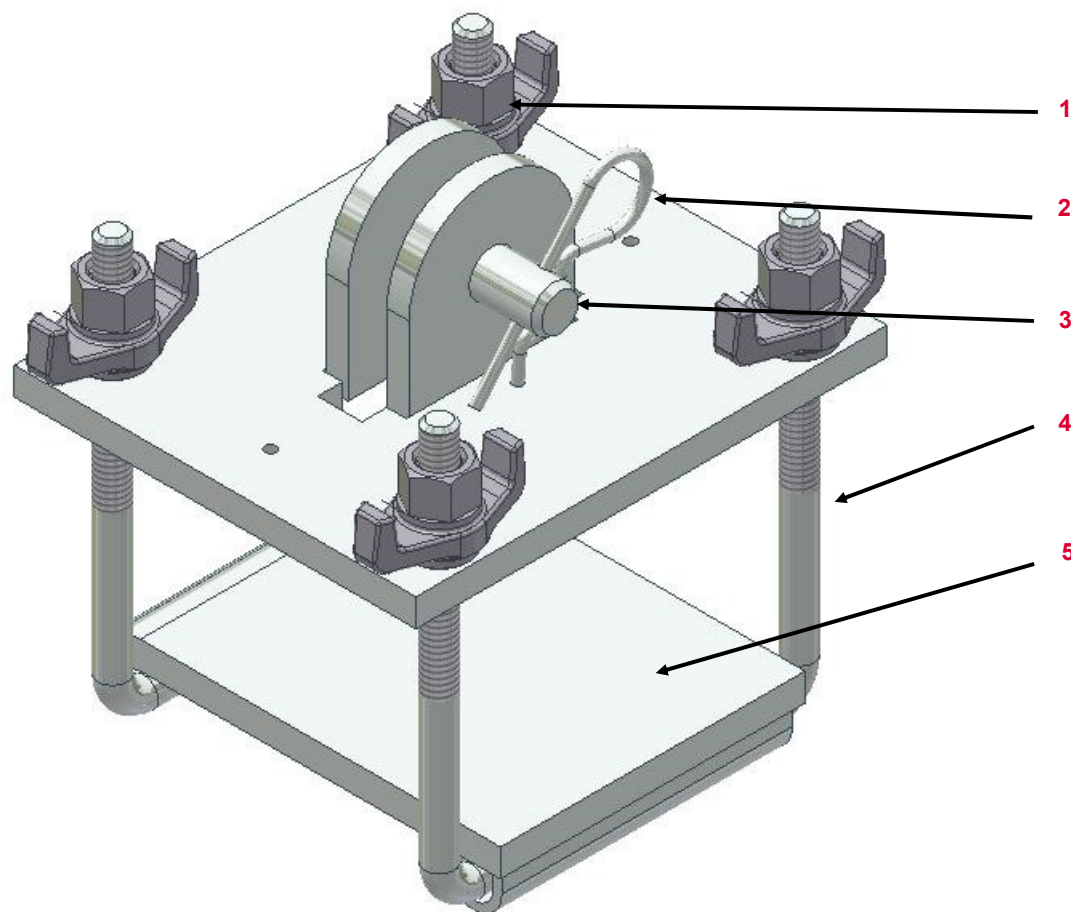

Sorsz.	Megnevezés	Cikkszám
1	Szárnyas anya	710338
2	Sasszeg 4/1	018060
3	Csap Ø 16 x 42	027170
4	Feszítő konzol	722683
5	Feszítőlemez	722685

PERI Bérleti kritériumok

Faltámaszok



Vario támaszkapcsoló GT 24	Leírás	Instrukció	Fizetési kondíció	Típus
----------------------------	--------	------------	-------------------	-------

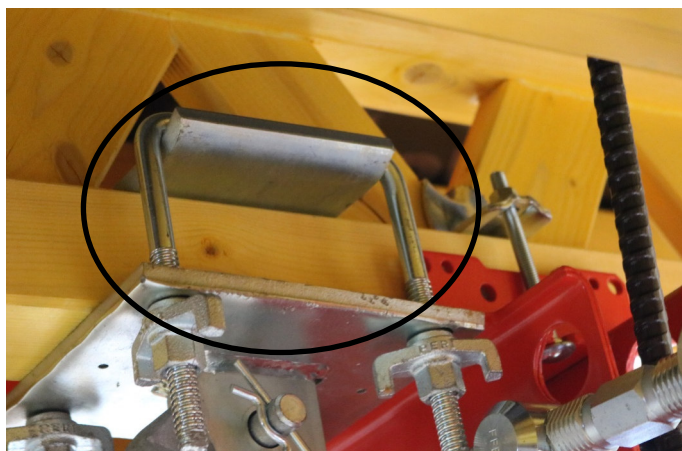

Feszítő konzol deformálódott |
belevágtak



722683 (Feszítő konzol)



088864



Szárnyas anya

■ Szárny törött



710330 (Szárnyas anya)



088862



■ Vagy hiányzik



710330 (Szárnyas anya)



088862



PERI Bérleti kritériumok

Faltámaszok



Vario támaszkapcsoló GT 24	Leírás	Instrukció	Fizetési kondíció	Típus
----------------------------	--------	------------	-------------------	-------

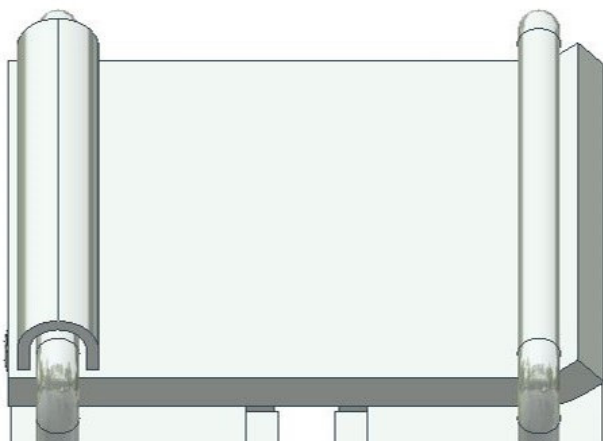

Feszítőlemez deformálódott | belevágtak



722685 (Feszítőlemez)

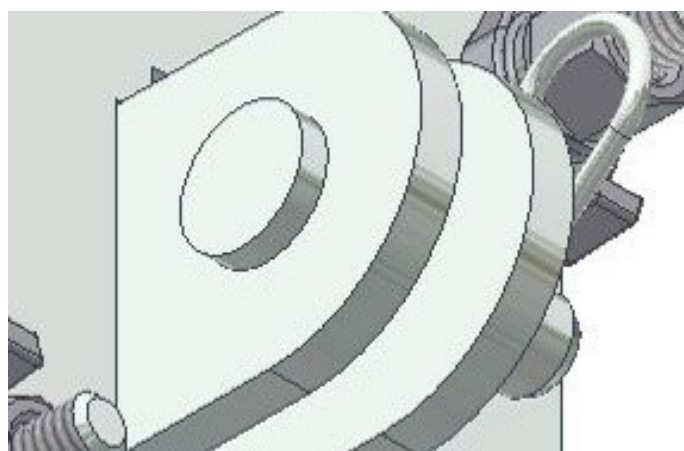

Csatlakozó lemez deformálódott

■ Ha lehetséges



088244



■ Vagy ha nem lehetséges



PERI Bérleti kritériumok

Faltámaszok



Támaszkapcsoló todónyelvhez GT 24 (028070)

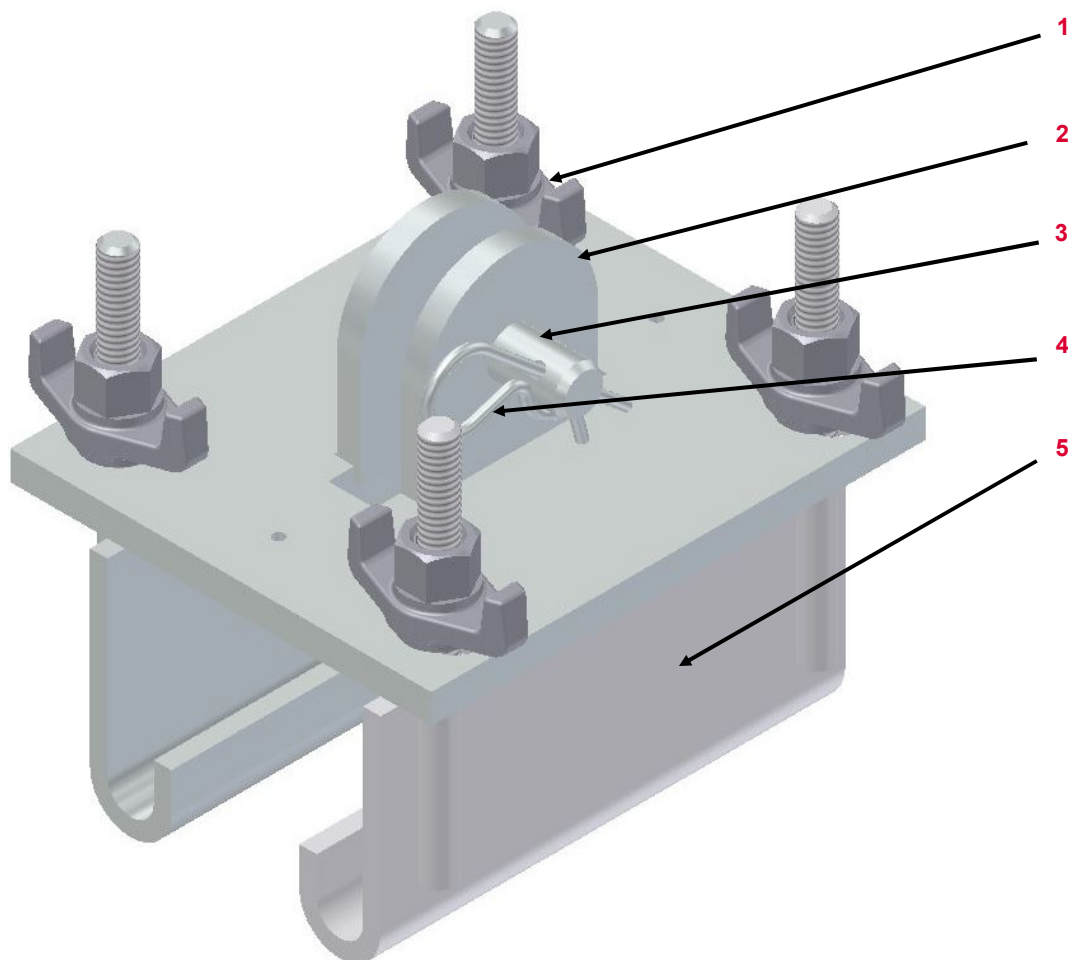

Sorsz.	Megnevezés	Cikkszám
1	Szárnyas anya	710338
2	Csatlakozó lemez	
3	Csap Ø 16 x 42	027170
4	Sasszeg 4/1	018060
5	Ívlemez	722735

PERI Bérleti kritériumok

Faltámaszok



Támaszkapcsoló toldányelvhez GT 24	Leírás	Instrukció	Fizetési kondíció	Típus
	<p>Ívlemez deformálódott</p>	722735 (Ívlemez)		
	<p>Szárnyas anya</p> <ul style="list-style-type: none"> ■ Hiányzik 	710338 (Szárnyas anya)		
	<ul style="list-style-type: none"> ■ Vagy törött a szárny 	710338 (Szárnyas anya)		
	<p>Csatlakozó lemez deformálódott</p> <ul style="list-style-type: none"> ■ Ha lehetséges ■ Vagy ha nem lehetséges 	 	088244 	

PERI Bérleti kritériumok

Faltámaszok



Vario támaszkapcsoló, ékes SRZ/ SRU (028060)	Sorsz.	Megnevezés	Cikkszám
--	--------	------------	----------

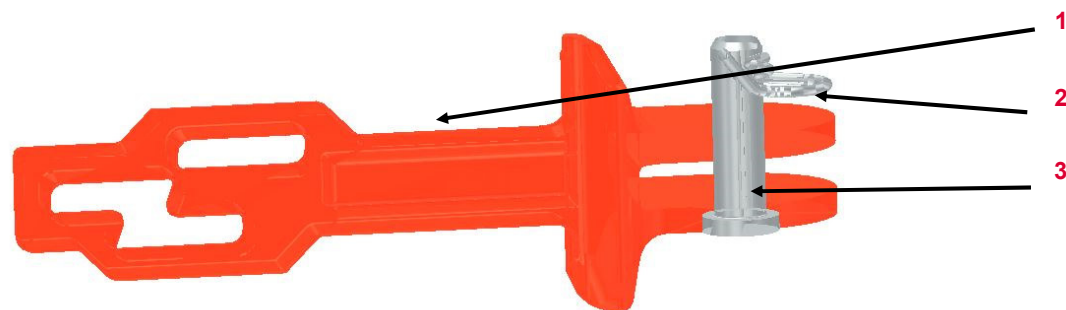

1	Ék fejrész		
2	Sasszeg 4/1	018060	
3	Csap Ø 16 x 42	027170	

Sérülés	Leírás	Instrukció	Fizetési kondíció	Típus
---------	--------	------------	-------------------	-------



Csap |sasszeg hiányzik



088192

















Deformálódott



PERI Bérleti kritériumok

Faltámaszok



TRIO támaszkapcsoló (023660)	Leírás	Instrukció	Fizetési kondíció	Típus	
	Repedés a hegesztésben				
	Repedés a hegesztésben, az anyag deformálódása miatt				
	Hajlott deformálódott			088244	
	Szárnyas anya törött				

PERI Bérleti kritériumok

Faltámaszok



Gyorskapcsoló fej RS-2 (127190)	Sorsz.	Megnevezés	Cikkszám
---------------------------------	--------	------------	----------

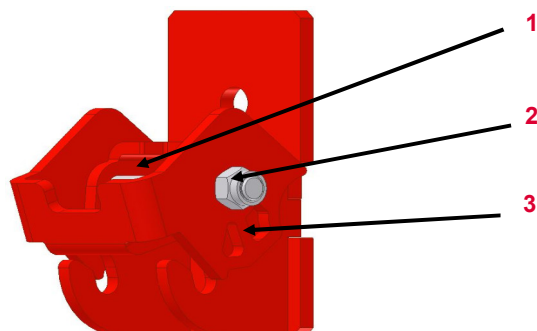

1	Hatl. csavar M 16 x 120	105402
2	Anyá M 16	070890
3	Retesz	726041

Sérülés	Leírás	Instrukció	Fizetési kondíció	Típus
---------	--------	------------	-------------------	-------

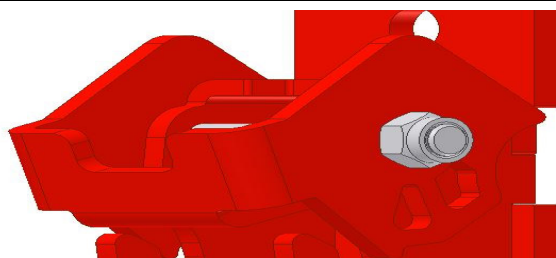

Retesz

- Sérült
- Vagy nem mozgatható



Hatl. Csavar

- Deformálódott
- Vagy hiányzik



PERI Bérleti kritériumok

Faltámaszok



Gyorskapcsoló RS (117470)

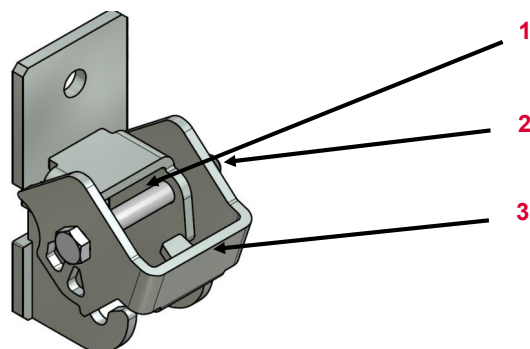

Sorsz.	Megnevezés	Cikkszám
1	Hatl. csavar M 16 x 120	710232
2	Anya M 16	070890
3	Retesz	118084

Sérülés	Leírás	Instrukció	Fizetési kondíció	Típus
---------	--------	------------	-------------------	-------

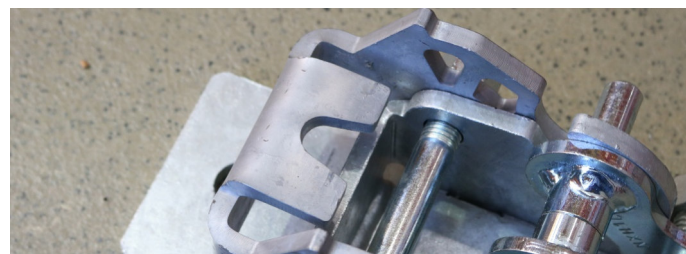

Retesz

- Deformálódott
- Vagy nem mozgatható



Hatl. Csavar

- Deformálódott
- Vagy hiányzik



PERI Bérleti kritériumok

Faltámaszok



RAPID támaszkapcsoló 3 (037190)

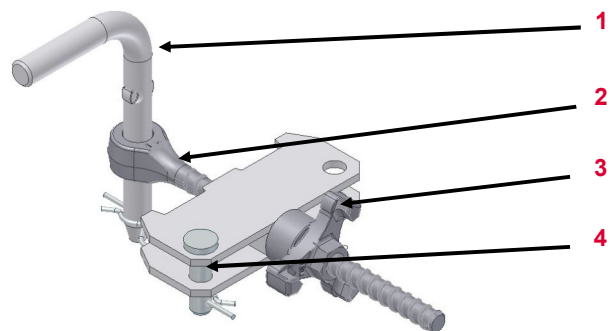

Sorsz.	Megnevezés	Cikkszám
1	Rapid Bizt. dugasz	037160
2	Átkötőrúd DW15	037150
3	Háromszárnyú anya	030190
4	Csap d16x42	027171

Sérülés

Leírás

Instrukció

Fizetési kondíció

Típus

Csatlakozó deformálódott



088244



Háromszárnyú anya törött



030190 (Szárnyas anya)



088541



PERI Bérleti kritériumok

Faltámaszok



QUATTRO támaszkapcsoló (037530)	Sorsz.	Megnevezés	Cikkszám
---------------------------------	--------	------------	----------

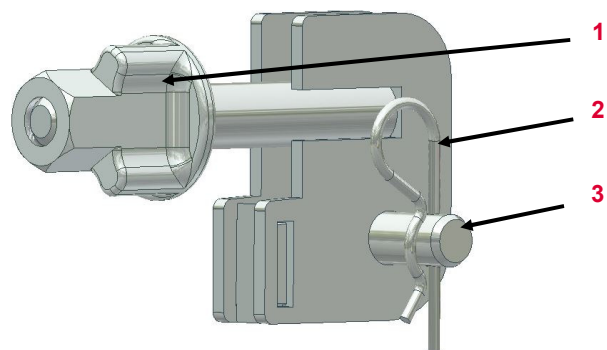

1	Bütykös anya	030130
2	Sasszeg 4/1	018060
3	Csap d16x42	027170

Sérülés	Leírás	Instrukció	Fizetési kondíció	Típus
---------	--------	------------	-------------------	-------



Bütykös anya selejt	030130 (Bütykös anya)	088429	
---------------------	-----------------------	--------	--



Deformálódott			
---------------	--	--	--

PERI Bérleti kritériumok

Faltámaszok



HDR / HDR-2 Faltámasz kapcsoló (022016 / 131723)

Sorsz. Megnevezés Cikkszám

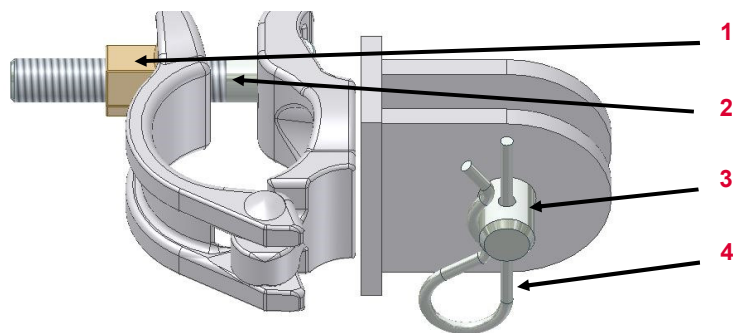

1	Anya	710340
2	Kalapácsfejű csavar	710702
3	Csap Ø 16 x 42	027170
4	Sasszeg 4/1	018060

Sérülés

Leírás

Instrukció

Fizetési kondíció

Típus

Csatlakozó fül deformálódott



088244

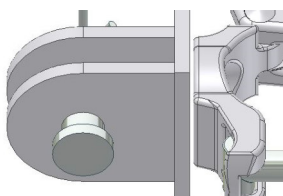

Csőbilincs deformálódott

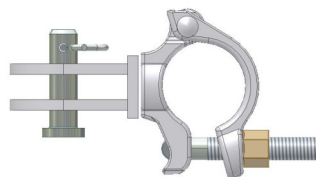

PERI Bérleti kritériumok

Faltámaszok



LIWA támaszkapcsoló (117169)

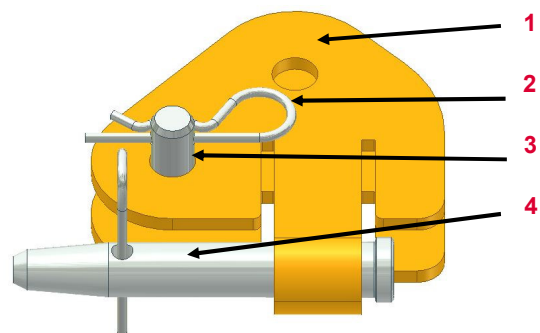

Sorsz.	Megnevezés	Cikkszám
1	Csatlakozó	
2	Sasszeg 4/1	018060
3	Csap Ø 16 x 42	027170
4	Csap Ø 20 x 140	105400

Sérülés

Leírás

Instrukció

Fizetési kondíció

Típus

Csatlakozó deformálódott

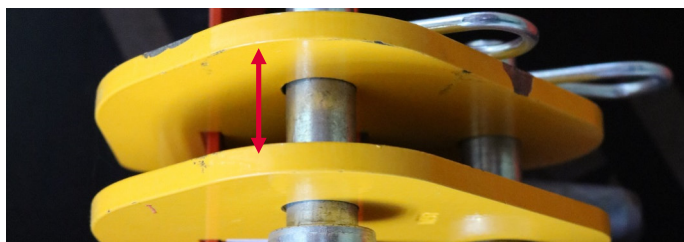

- Ha lehetséges
- Vagy ha nem lehetséges



Csap | sasszeg hiányzik

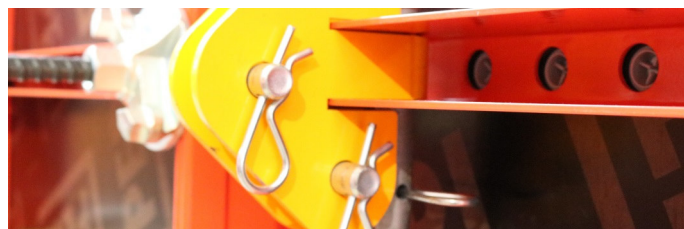

088138



PERI Bérleti kritériumok

Faltámaszok



Faltámasz talp AV/ RS (028080)	Sorsz.	Megnevezés	Cikkszám
--------------------------------	--------	------------	----------

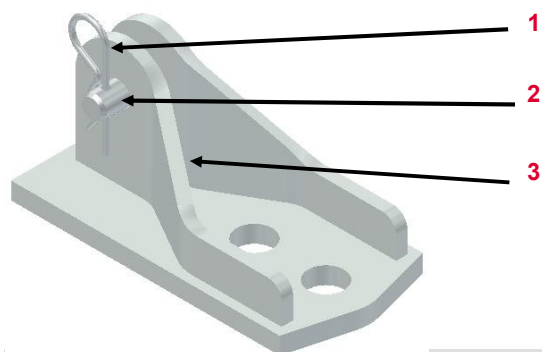

1	Sasszeg 4/1	018060
2	Csap Ø 16 x 42	027170
3	Csatlakozó lemez	

Sérülés	Leírás	Instrukció	Fizetési kondíció	Típus
---------	--------	------------	-------------------	-------



Csatlakozó lemez deformálódott

- Ha lehetséges
- Vagy ha nem lehetséges



Csap | Sasszeg hiányzik



088192



PERI Bérleti kritériumok

Faltámaszok



Orsófogantyú RSS / AV (113397)	Leírás	Instrukció	Fizetési kondíció	Típus
--------------------------------	--------	------------	-------------------	-------

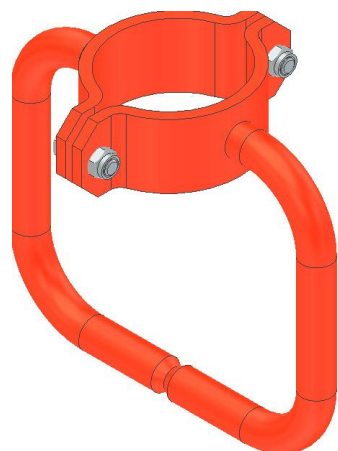

Deformálódott

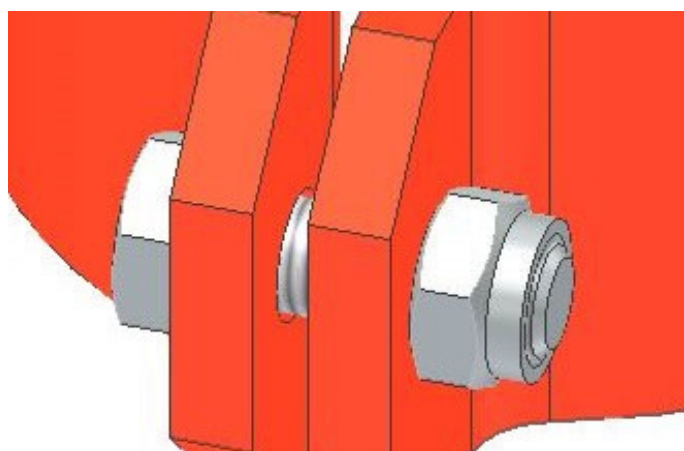

Hatl. Csavar / Anya

- Hiányzik
- Vagy használhatatlan



722342 (Hatl. Csavar)
711071 (Anya)



















722342 (Hatl. Csavar)
711071 (Anya)



PERI Bérleti Kritériumok

Magyarázat



Ikon	Jelentés	Ikon	Jelentés	Ikon	Jelentés
	Nem OK — kicselezendő		Ügyfélnek leszámházandó		Optikai kár
	OK– marad a bérleti parkban		Nincs számlázás		Funkcionális sérülés
	Selejt anyag – biztonsági okokból az anyagot tilos kiadni		Anyagot levágni		Funkcionális sérülés — anyag kiadása nem engedélyezett
	Javítás az előírások szerint		Anyagot megjelölni		Statikai sérülés — anyag kiadása nem engedélyezett
	Hideg egyengetés — utána a varratokat és a környékét ellenőrzni kell		Sérült anyag cseréje		
	Javítás gazdaságosság függvényében		Hiányzó anyag cseréje		
	Megtisztítani az anyagot				