

# PERI Bérleti kritériumok

## Függesztett állványok

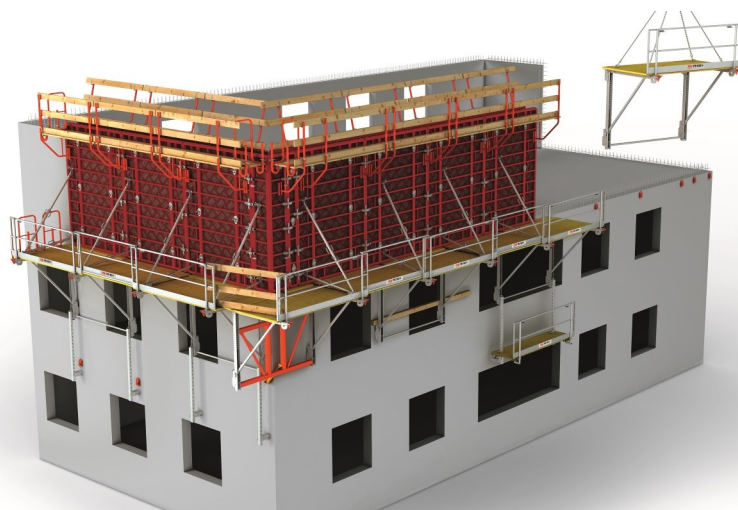

### Kapcsolat

**PERI Kft,**  
**Zsaluzatok, állványzatok,**  
**mérnöki szolgáltatás**  
H-1181 Budapest  
Zádor u. 9.  
Tel.: +36-1-296-09-60  
[www.peri.hu](http://www.peri.hu)

Tartalom	Oldal
FB állvány	2
CB végfalállvány	26
ASG munkaállvány	61
Magyarázat	70

Módosítások	Dátum  Kezdőbetű	Oldal
Új verzió	07/2021   O.L.	
Platform ASG Board bent hozzáadva	04/19   fw	64
FB   Main Plattform Board hajlása	05/19   fw	

# PERI Bérleti kritériumok

## Függesztett állványok



FB állvány	Sorszám	Megnevezés	Cikkszám
------------	---------	------------	----------

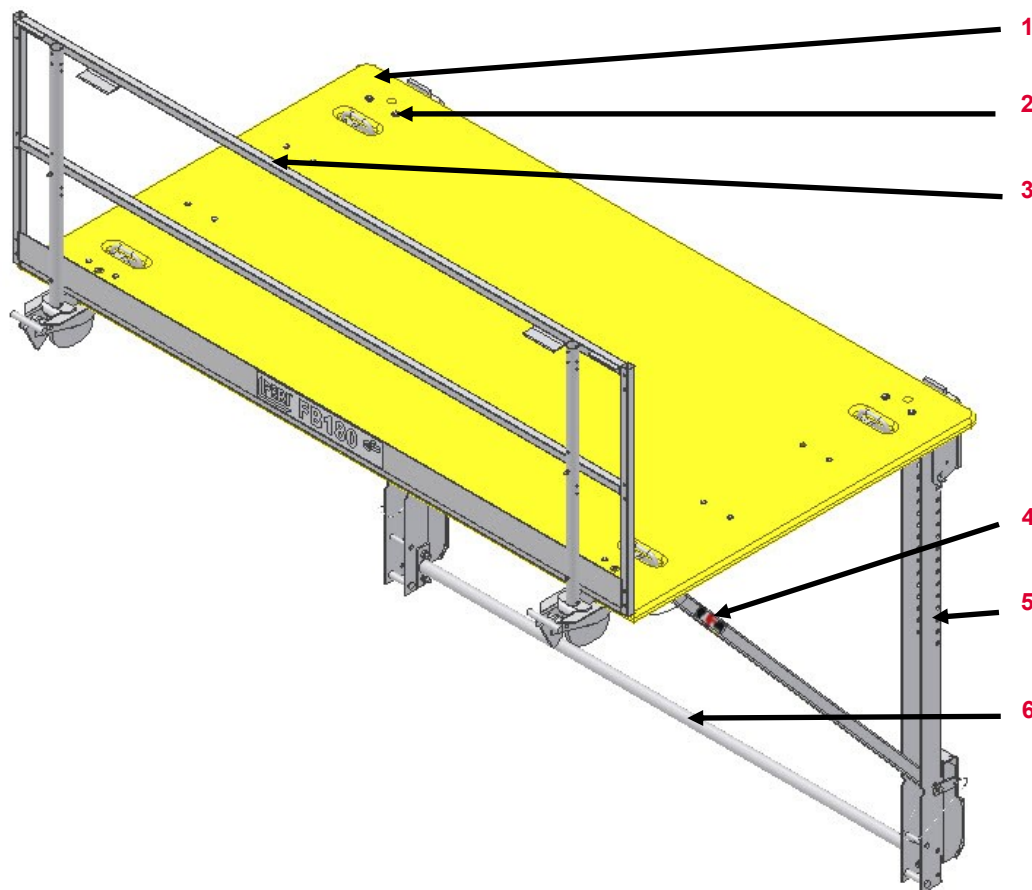















1	Rétegelt lemez
2	Csavar M8 x 60
3	Korlát FB
4	Konzol tartó
5	Konzol
6	Vízszintes támasz

Megnevezés	Cikkszám
Állvány FB 180 - 3/300	026648
Sarokállvány FEB 180 - 3/300	026649
Közb. állvány FBZ 240	026622
M. állvány FBN-2/300	026625

# PERI Bérleti kritériumok

## Függesztett állványok















FB állvány	Leírás	Instrukció	Fizetési kondíció	Típus	
	<b>Sarkán sérült rétegelt lemez</b>	<ul style="list-style-type: none"> <li>■ ≤ 3 cm</li> </ul>	 Kiegyengetés, nem lehet botlás-veszély		
	<ul style="list-style-type: none"> <li>■ Vagy &gt; 3 cm</li> </ul>				
	<b>Hasadás</b>	<ul style="list-style-type: none"> <li>■ ≤ 3 cm</li> </ul>	 Kiegyengetés, nem lehet botlás-veszély		
	<ul style="list-style-type: none"> <li>■ Vagy &gt; 3 cm</li> </ul>				

# PERI Bérleti kritériumok

## Függesztett állványok













FB állvány	Leírás	Instrukció	Fizetési kondíció	Típus
	<p>Kopott rétegelt lemez</p>			
	<p>Fúrt lyuk</p>	<ul style="list-style-type: none"> <li>■ ≤ Ø 20mm és max 1 / m<sup>2</sup></li> </ul>		
	<ul style="list-style-type: none"> <li>■ Vagy &lt; 20 mm</li> </ul>			
	<ul style="list-style-type: none"> <li>■ Vagy egynél több lyuk m<sup>2</sup></li> </ul>			



# PERI Bérleti kritériumok

## Függesztett állványok

















FB állvány	Leírás	Instrukció	Fizetési kondíció	Típus
	<b>Meghajlott korlátoszlop</b>			
	<ul style="list-style-type: none"><li>■ <math>\leq 5</math> cm</li><li>■ Vagy <math>&gt; 5</math> cm</li></ul>	 	 	 
	<b>Hajlott kapcsolóelem</b>			
	<ul style="list-style-type: none"><li>■ Az aljzat nem funkcionál</li></ul>			

# PERI Bérleti kritériumok

## Függesztett állványok



















FB állvány	Leírás	Instrukció	Fizetési kondíció	Típus
	<p><b>Meghajlott korlát</b></p> <ul style="list-style-type: none"> <li>■ Ha lehetséges</li> <li>■ Vagy ha nem lehetséges</li> </ul>	 	 	 
 <p>130/10/12 FFB Totalschaden</p>	<p><b>Hajlott konzol</b></p> <ul style="list-style-type: none"> <li>■ Ha lehetséges</li> <li>■ Vagy ha nem lehetséges</li> </ul>	 	 	 

# PERI Bérleti kritériumok

## Függesztett állványok



FB állvány	Leírás	Instrukció	Fizetési kondíció	Típus
 <p>068.06.11a Horizontalstab verbogen</p>	<b>Hajlott vízszintes támasz</b> <ul style="list-style-type: none"> <li>■ <math>\leq 5</math> cm És lehetséges visszahajlítás</li> </ul>			
	<ul style="list-style-type: none"> <li>■ Vagy <math>&gt; 5</math> cm</li> </ul>			
	<ul style="list-style-type: none"> <li>■ Vagy repedés a hegesztés</li> </ul>			
	<b>Hajlott tábla</b> <ul style="list-style-type: none"> <li>■ <math>\leq</math> Hajlás (l/100) <ul style="list-style-type: none"> <li>■ FB 300= 30 mm</li> <li>■ FB 240= 24mm</li> </ul> </li> </ul>			
	<ul style="list-style-type: none"> <li>■ vagy <math>&gt;</math> hajlás</li> </ul>			

# PERI Bérleti kritériumok

## Függesztett állványok



### Csuklós konzol FB 180-3 (026652)

Sorszám Megnevezés Cikkszám

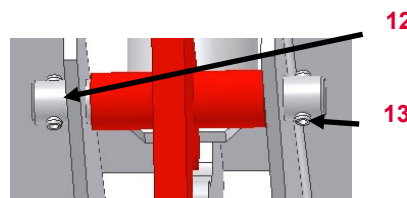
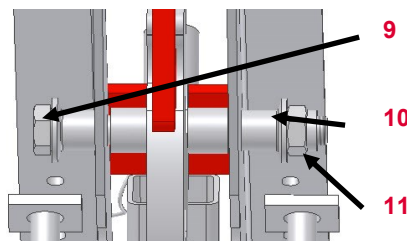
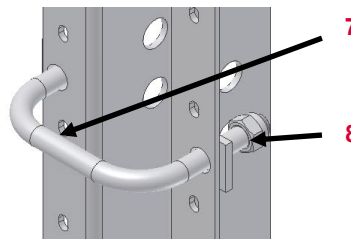
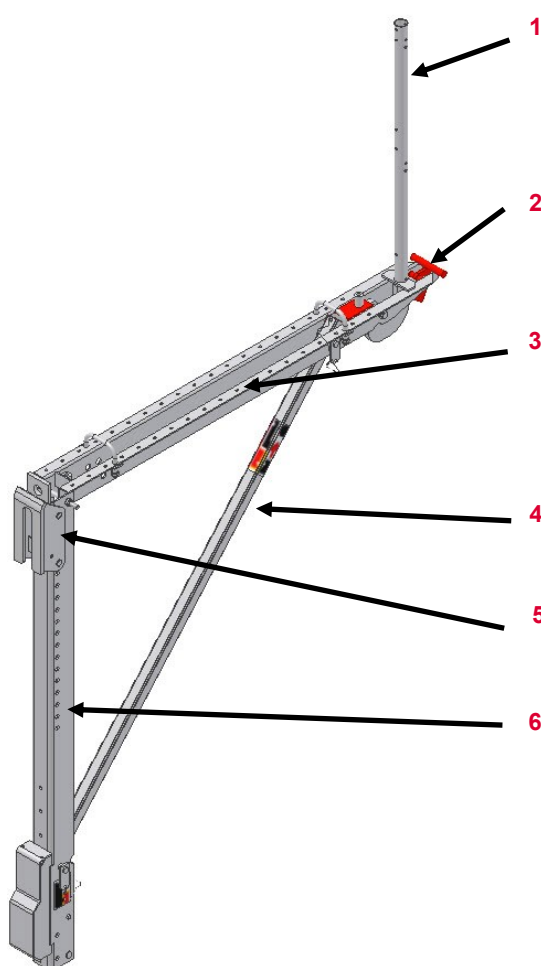















1	FB-3 korláttartó	716268
2	Aljzat	716256
3	Konzol	
4	FIX merevítőtámasz	026651
5	FB-3 akasztófej	026632
6	Függőleges profil FB	716243
7	Daruhorog kapcsolóhorgony	710499
8	Önzáró SKT anya ISO	070890
9	Csavar M 16 x 150	710049
10	Hüvely	710496
11	Önzáró SKT anya ISO	070890
12	Biztosító tengely	710498
13	Feszítőtift	780801



# PERI Bérleti kritériumok

## Függesztett állványok



Csuklós konzol FB 180-3	Leírás	Instrukció	Fizetési kondíció	Típus
	<b>Hajlott konzol</b> <ul style="list-style-type: none"> <li>■ Ha lehetséges</li> </ul>			
	<ul style="list-style-type: none"> <li>■ Vagy ha nem lehetséges</li> </ul>			
	<b>Csavar   Anya   Csap</b> <ul style="list-style-type: none"> <li>■ Hiányzik</li> </ul>			
	<ul style="list-style-type: none"> <li>■ Vagy sérült erőfeszítésből</li> </ul>			

# PERI Bérleti kritériumok

## Függesztett állványok



### Munkaállvány FBN-2 (026631)

Sorszám	Megnevezés	Cikkszám
---------	------------	----------

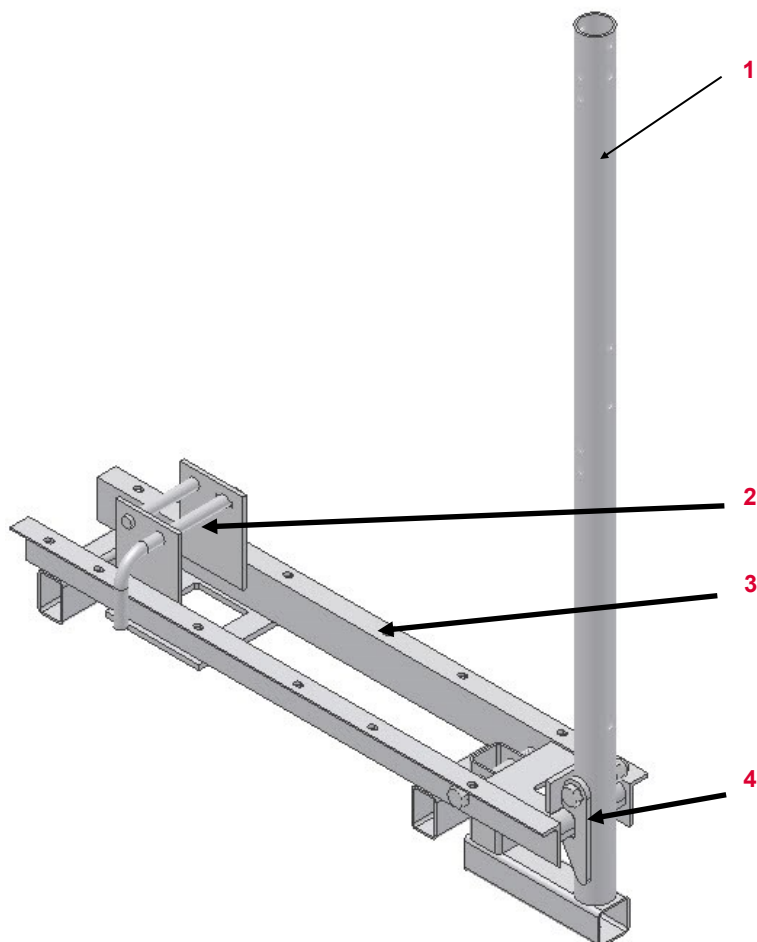

1	Korlátozszlop	722157
2	Korlátozszlop csatlakozó	722167
3	Vízszintes merevítő	722166
4	Retesz	722150

# PERI Bérleti kritériumok

## Függesztett állványok



Munkaállvány FBN-2	Leírás	Instrukció	Fizetési kondíció	Típus
--------------------	--------	------------	-------------------	-------

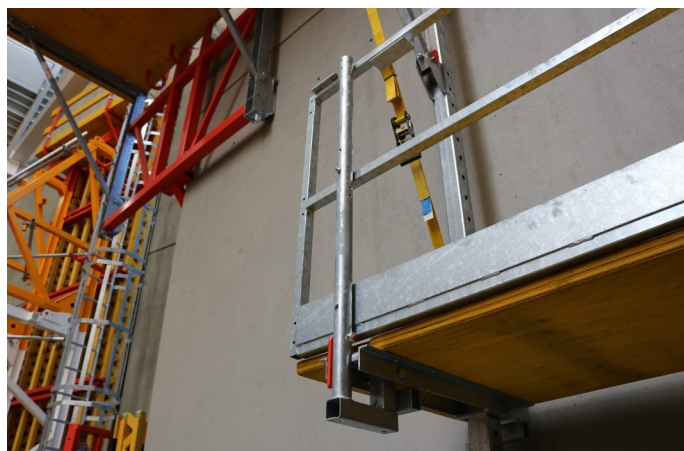

### Korlátooszlop

- Hiányzik
- Vagy sérült erőfeszítésből

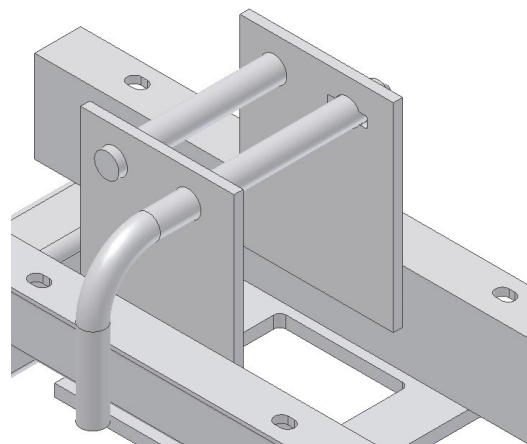

### Csatlakozó

- Hiányzik
- Vagy sérült erőfeszítésből



722167 (Csatlakozó)  
780801 (Feszítőstift)

722167 (Csatlakozó)  
780801 (Feszítőstift)



# PERI Bérleti kritériumok

## Függesztett állványok



Munkaállvány FBN-2	Leírás	Instrukció	Fizetési kondíció	Típus
	<p><b>A csatlakozó nem funkcionál</b></p> <ul style="list-style-type: none"> <li>■ Sérült erőfeszítésből</li> <li>■ Vagy nem funkcionál (Csatlakozó nem biztosít)</li> </ul>			
	<p><b>Hajlás</b></p> <ul style="list-style-type: none"> <li>■ Ha lehetséges</li> <li>■ Vagy ha nem lehetséges</li> </ul>			



# PERI Bérleti kritériumok

## Függesztett állványok



### Támaszhosszabbító FB-2 (026623; 026624)

Sorszám      Megnevezés      Cikkszám

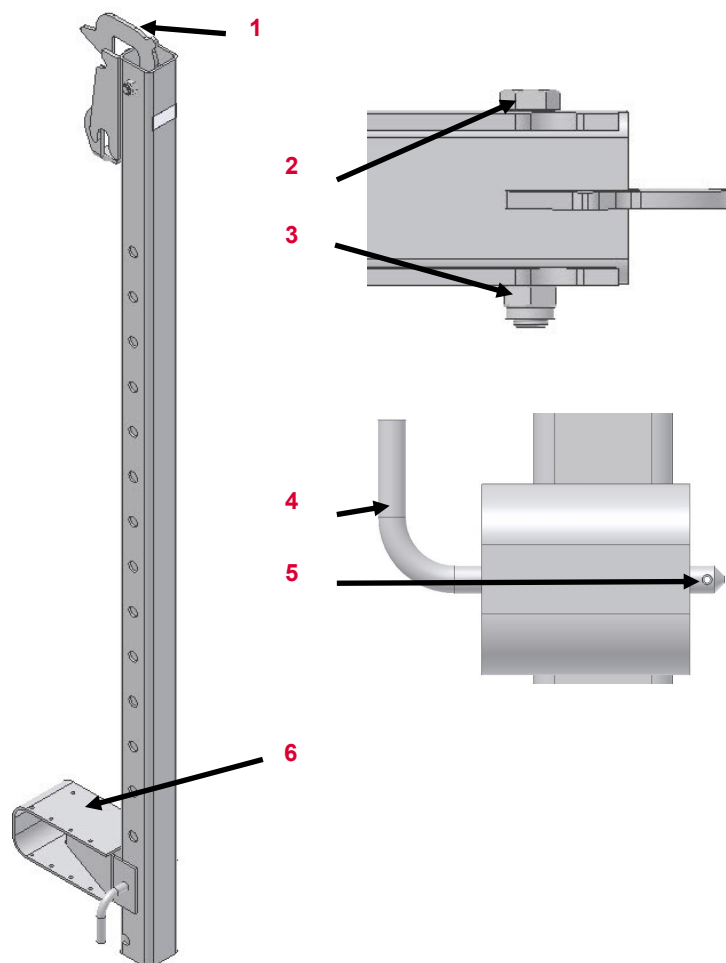

1	retesz	722178
2	Csavar M 16	710219
3	Anya M 16	070890
4	Csatlakozó 16 x 140	722167
5	Feszítőstift	780801
6	Támasztó konzol	722182

# PERI Bérleti kritériumok

## Függesztett állványok











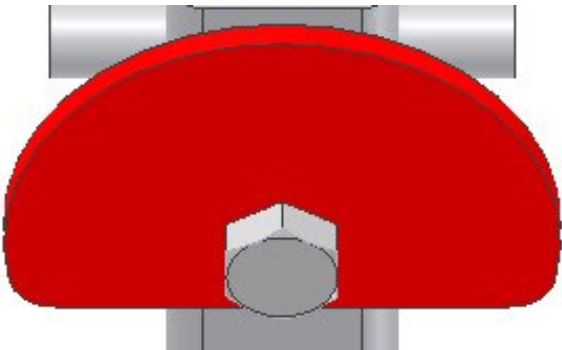

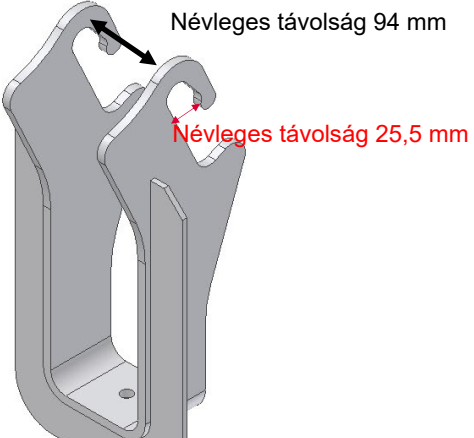

Támaszhosszabbító FB-2	Leírás	Instrukció	Fizetési kondíció	Típus
	<b>Csavar   Anya   Csatlakozó</b>			
	<ul style="list-style-type: none"> <li>■ Hiányzik</li> </ul>			
	<ul style="list-style-type: none"> <li>■ Vagy sérült erőfeszítésből</li> </ul>			
	<b>Támasztó konzol</b>			
	<ul style="list-style-type: none"> <li>■ Hiányzik</li> </ul>			
	<ul style="list-style-type: none"> <li>■ Vagy sérült erőfeszítésből</li> </ul>			

# PERI Bérleti kritériumok

## Függesztett állványok



Merevítő szár FB-2 (026627)	Leírás	Instrukció	Fizetési kondíció	Típus
	<p><b>Aljzat   Csavar   Anya</b></p> <ul style="list-style-type: none"> <li>■ Hiányzik</li> </ul>	 <p>722204 (Aljzat) 710222 (Csavar) 070890 (Anya)</p>		
	<ul style="list-style-type: none"> <li>■ Vagy sérült erőfeszítésből</li> </ul>	 <p>722204 (Aljzat) 710222 (Csavar) 070890 (Anya)</p>		
	<p><b>Hajlott konzol</b></p> <ul style="list-style-type: none"> <li>■ Ha lehetséges</li> </ul>			
	<ul style="list-style-type: none"> <li>■ Vagy ha nem lehetséges</li> </ul>			

# PERI Bérleti kritériumok

## Függesztett állványok



### Sarokállvány keret FBE (026626)

Sorszám	Megnevezés	Cikkszám
---------	------------	----------

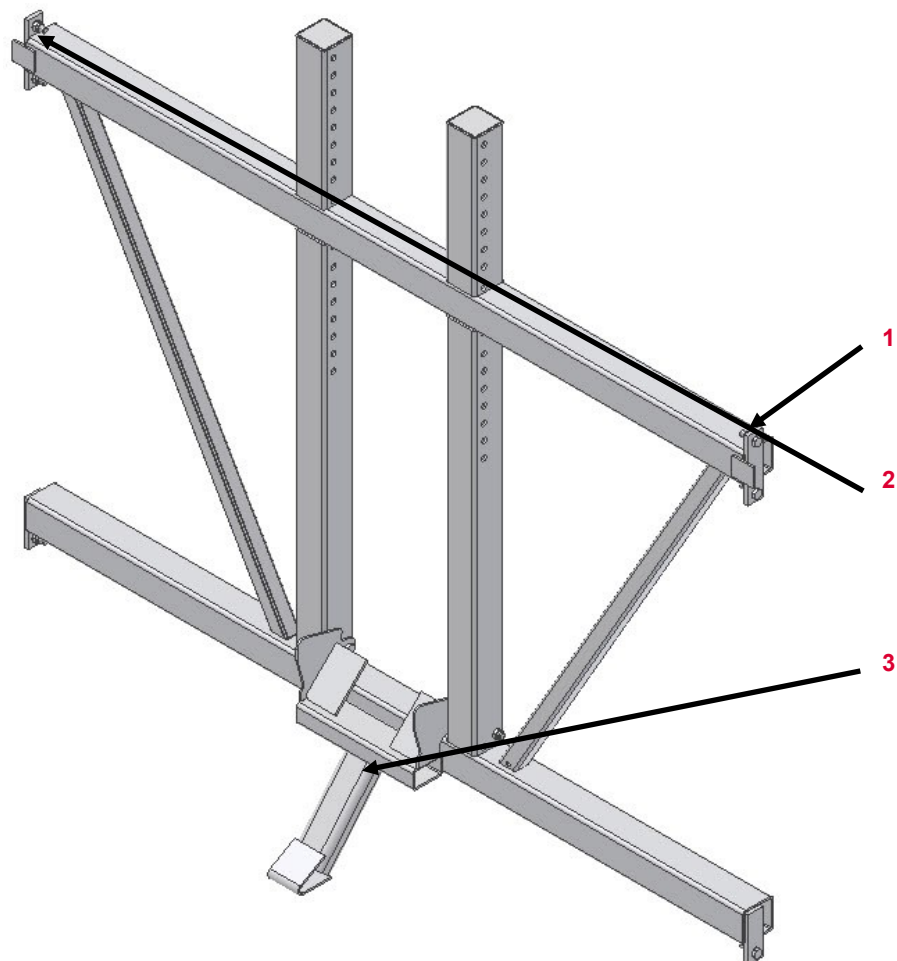

1	CsavarM16 x 45	710225
2	Anyá M 16	070890
3	Támasztóláb	720794
4	Csavar M 16 x 130	710232

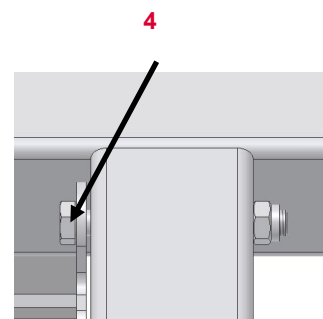













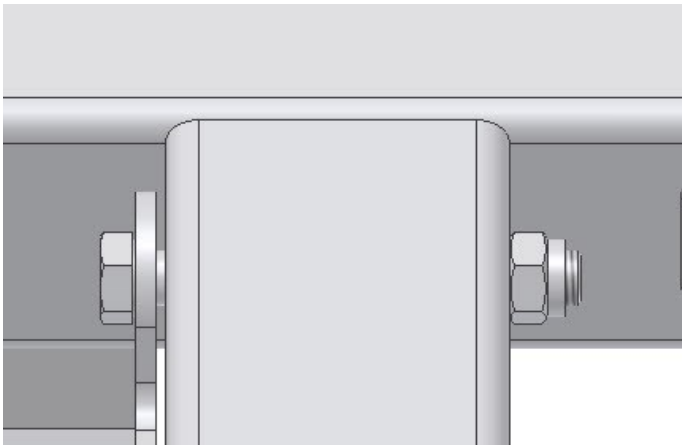

# PERI Bérleti kritériumok

## Függesztett állványok



















Sarokeret	Leírás	Instrukció	Fizetési kondíció	Típus
	<b>Támasztóláb</b>			
	<ul style="list-style-type: none"> <li>■ Hiányzik</li> </ul>			
	<ul style="list-style-type: none"> <li>■ Vagy hajlott</li> </ul>			
	<b>Csavar  Anya</b>			
	<ul style="list-style-type: none"> <li>■ Hiányzik</li> </ul>			
	<ul style="list-style-type: none"> <li>■ Vagy sérült erőfeszítésből</li> </ul>			

# PERI Bérleti kritériumok

## Függesztett állványok



Korláttartó FBP (026628)	Leírás	Instrukció	Fizetési kondíció	Típus
	<b>Csúszó darab</b> <ul style="list-style-type: none"> <li>■ Hiányzik</li> </ul>	 715185 (Csúszó darab) 710287 (Feszítőstift)		
	<ul style="list-style-type: none"> <li>■ Vagy sérült erőfeszítésből</li> </ul>	 715185 (Csúszó darab) 710287 (Feszítőstift)		
	<b>Összekötő rúd hajlott</b> <ul style="list-style-type: none"> <li>■ Ha lehetséges</li> </ul>			
	<ul style="list-style-type: none"> <li>■ Vagy ha nem lehetséges</li> </ul>			
	<ul style="list-style-type: none"> <li>■ Vagy törés az anyagban</li> </ul>			

# PERI Bérleti kritériumok

## Függesztett állványok



Domino homlok korlát 55 (065066)	Leírás	Instrukció	Fizetési kondíció	Típus
----------------------------------	--------	------------	-------------------	-------



### Szárnyasanya

■ Hiányzik



065047 (Szárnyasanya)



■ Vagy törött



065047 (Szárnyasanya)

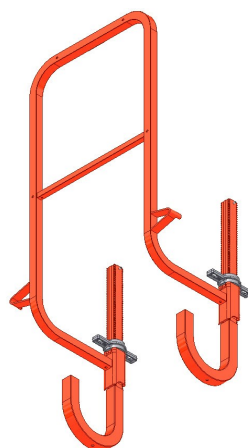

### Hajlott

■ Ha lehetséges



■ Vagy ha nem lehetséges



# PERI Bérleti kritériumok

## Függesztett állványok



CB Végkorlát -oszlop (051630)	Leírás	Instrukció	Fizetési kondíció	Típus
	<b>Lemezek hajlottak</b>			
	<ul style="list-style-type: none"> <li data-bbox="869 568 1294 603">■ Ha lehetséges</li> <li data-bbox="869 708 1294 740">■ Vagy ha nem lehetséges</li> </ul>	<div data-bbox="1305 544 1373 612" style="text-align: center;"> </div> <div data-bbox="1305 692 1373 761" style="text-align: center;"> </div>	<div data-bbox="1798 544 1865 612" style="text-align: center;"> </div> <div data-bbox="1798 692 1865 761" style="text-align: center;"> </div>	<div data-bbox="2089 544 2161 612" style="text-align: center;"> </div> <div data-bbox="2089 692 2161 761" style="text-align: center;"> </div>
	<b>Zártszelvény hajlott vagy horpadt</b>	<div data-bbox="1305 994 1373 1062" style="text-align: center;"> </div>	<div data-bbox="1798 994 1865 1062" style="text-align: center;"> </div>	<div data-bbox="2089 994 2161 1062" style="text-align: center;"> </div>

# PERI Bérleti kritériumok

## Függesztett állványok



Korlát magasztó FB (026635)	Leírás	Instrukció	Fizetési kondíció	Típus	
	<b>Csőbilincs</b>				
	<ul style="list-style-type: none"> <li>■ Sérült (Nem funkcionál)</li> </ul>				
	<ul style="list-style-type: none"> <li>■ Kalapácsfejű csavar/anya hiányzik</li> </ul>		131316 (Kalapácsfej csavar) 710340 (Anyá)		
	<b>Csap</b>				
	<ul style="list-style-type: none"> <li>■ Hiányzik</li> </ul>		770012 (Feszítőstift)		
	<ul style="list-style-type: none"> <li>■ Vagy sérült erőfeszítésből</li> </ul>		770012 (Feszítőstift)		

# PERI Bérleti kritériumok

## Függesztett állványok













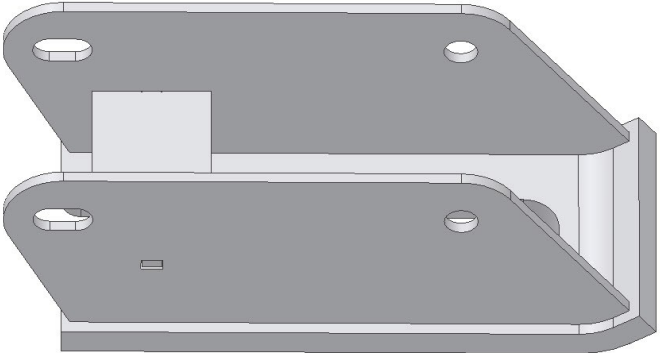

Hurokfej-2 FB (026645)	Leírás	Instrukció	Fizetési kondíció	Típus
 <p>Névleges távolság 105 mm</p>	<p><b>Hajlott</b></p> <ul style="list-style-type: none"> <li>■ Ha lehetséges</li> <li>■ Vagy ha nem lehetséges</li> </ul>	  	  	  

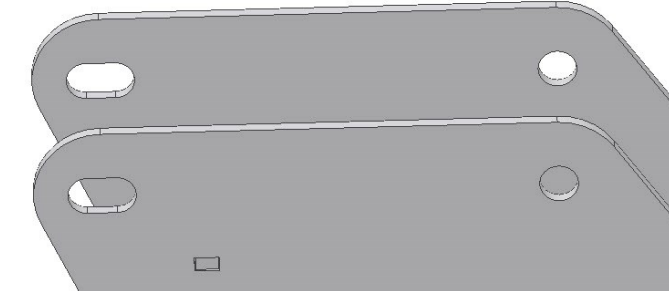

# PERI Bérleti kritériumok

## Függesztett állványok













Akasztófej FB (026632)	Leírás	Instrukció	Fizetési kondíció	Típus
	<b>Hajlott</b>	<ul style="list-style-type: none"> <li>■ Ha lehetséges </li> </ul>		
	<ul style="list-style-type: none"> <li>■ Vagy ha nem lehetséges</li> </ul>			
	<b>Csatlakozó lyukak kopottak</b>	<ul style="list-style-type: none"> <li>■ Eredeti alakja megvan </li> </ul>		
	<ul style="list-style-type: none"> <li>■ Nincs meg az eredeti alakja</li> </ul>			

# PERI Bérleti kritériumok

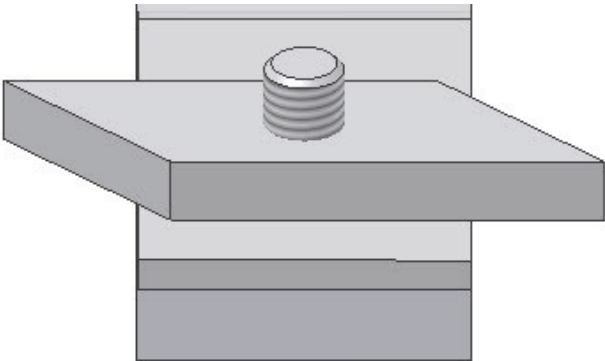
## Függesztett állványok



Létrakorlát (051450   104132)	Leírás	Instrukció	Fizetési kondíció	Típus
	<b>Hajlott</b> <ul style="list-style-type: none"> <li>■ Ha lehetséges</li> </ul>			
	<ul style="list-style-type: none"> <li>■ Vagy ha nem lehetséges</li> </ul>			
	<b>Szorítólemez (anya) hiányzik</b>		707763 (Szorítólemez) 710266 (Csavar)	 

# PERI Bérleti kritériumok

## Függesztett állványok



Állványcső csatlakozó (026644)	Leírás	Instrukció	Fizetési kondíció	Típus
--------------------------------	--------	------------	-------------------	-------

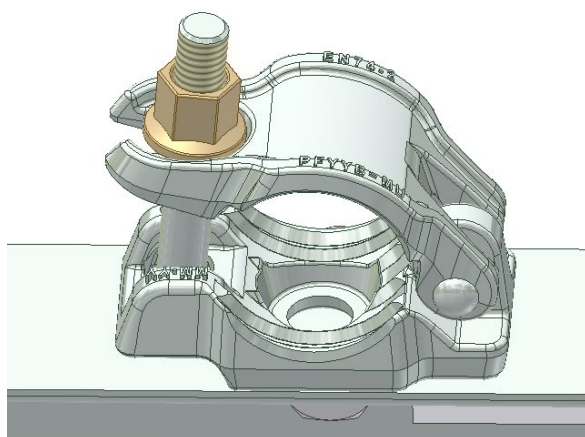

Csatlakozó sérült | Hiányos

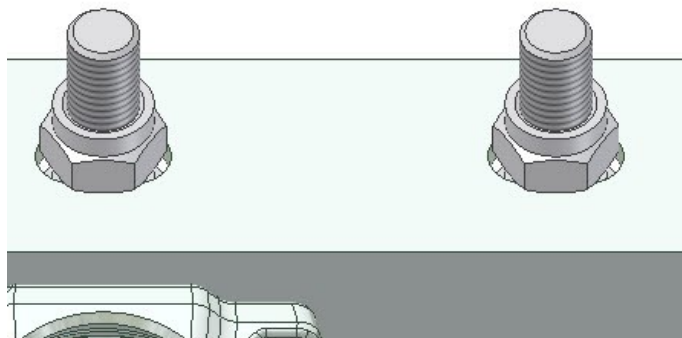

Csavar | Anya Hiányzik



710225 (Csavar)  
070890 (Any)



# PERI Bérleti kritériumok

## Függesztett állványok



### Végfalállvány CB (051100 | 051000)

Sorszám	Megnevezés	Cikkszám 240	Cikkszám 160
---------	------------	--------------	--------------

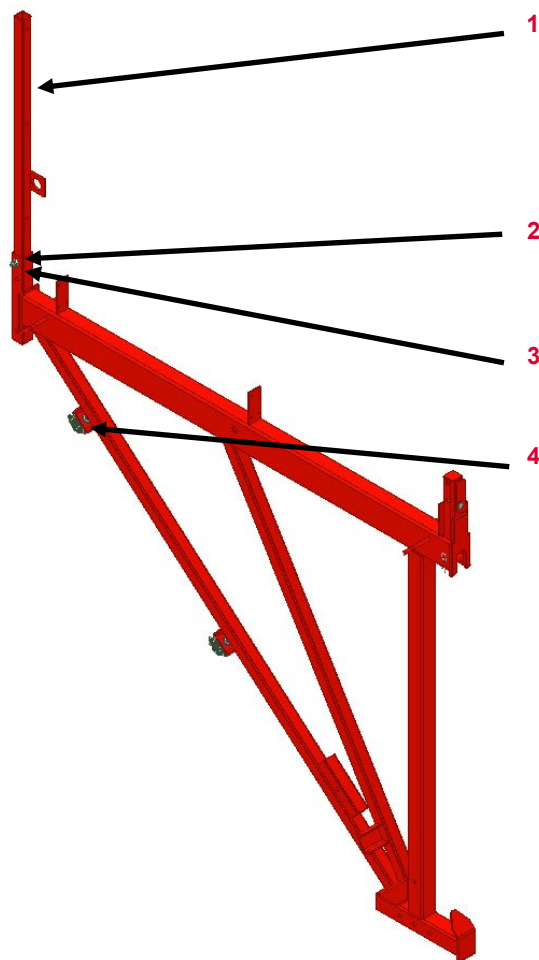



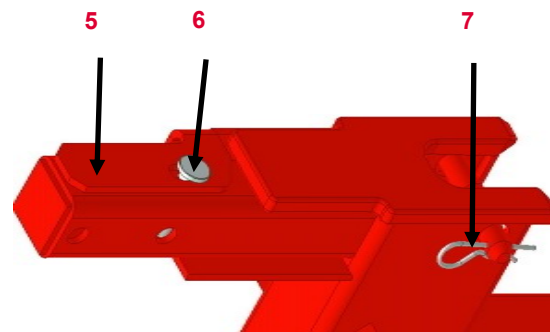

















1	Védőkorlát	715977	701209
2	Csavar M 16 x 90	721729	
3	Anya M 16	070890	
4	Csőbilincs csavaros 48	017040	017040
5	Biztosító zár	111147	
6	Biztosító csap	111147	
7	Sasszeg	018060	



# PERI Bérleti kritériumok

## Függesztett állványok











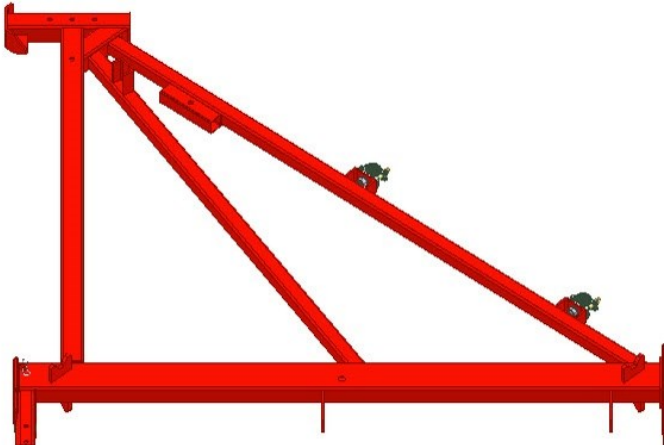







Végfalállvány CB	Leírás	Instrukció	Fizetési kondíció	Típus
	<b>Védőkoriát tartó hajlott</b>			
	■ Ha lehetséges			
	■ Vagy ha nem lehetséges			
	■ Vagy ha törés az anyagban			
	<b>Rögzőtőfül hajlott</b>			
	■ Ha lehetséges			
	■ Vagy ha nem lehetséges	 701222 (Rögzőtőfül)		
	■ Vagy > 45 °	 701222 (Rögzőtőfül)		

# PERI Bérleti kritériumok

## Függesztett állványok















Végfalállvány CB	Leírás	Instrukció	Fizetési kondíció	Típus
	<b>Merevítő hajlott</b>  <ul style="list-style-type: none"> <li>■ <math>\leq 1/300</math></li> </ul>			
	<ul style="list-style-type: none"> <li>■ Vagy <math>&gt; 1/300</math></li> </ul>			
	<b>Horpadás</b>  <ul style="list-style-type: none"> <li>■ <math>\leq 5</math> mm mély</li> </ul>			
	<ul style="list-style-type: none"> <li>■ Vagy <math>&gt; 5</math> mm</li> </ul>			
	<ul style="list-style-type: none"> <li>■ Vagy az élek érintettek</li> </ul>			

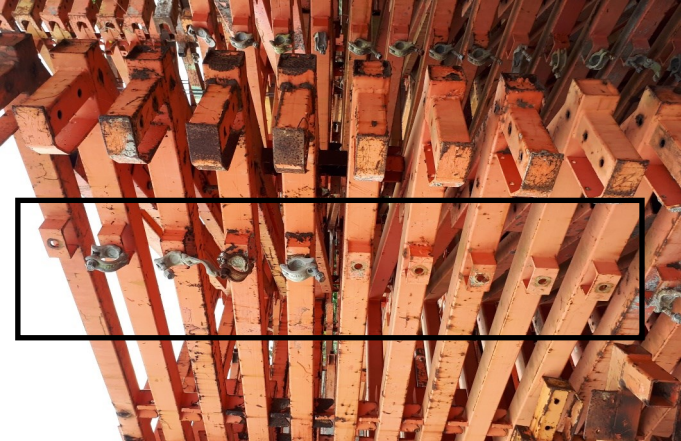

# PERI Bérleti kritériumok

## Függesztett állványok



Végfalállvány CB	Leírás	Instrukció	Fizetési kondíció	Típus
	<b>Biztosító zár</b> <ul style="list-style-type: none"> <li>■ Hiányzik</li> </ul>			
	<ul style="list-style-type: none"> <li>■ Vagy hajlott</li> </ul>			
	<b>Csavaros csőbilincs az összekötőben</b> <ul style="list-style-type: none"> <li>■ Hiányzik</li> </ul>			
	<ul style="list-style-type: none"> <li>■ Vagy sérült erőfeszítésből</li> </ul>			

# PERI Bérleti kritériumok

## Függesztett állványok



### Mozgató kocsi CB 240 (051020)

Sorszám      Megnevezés      Cikkszám

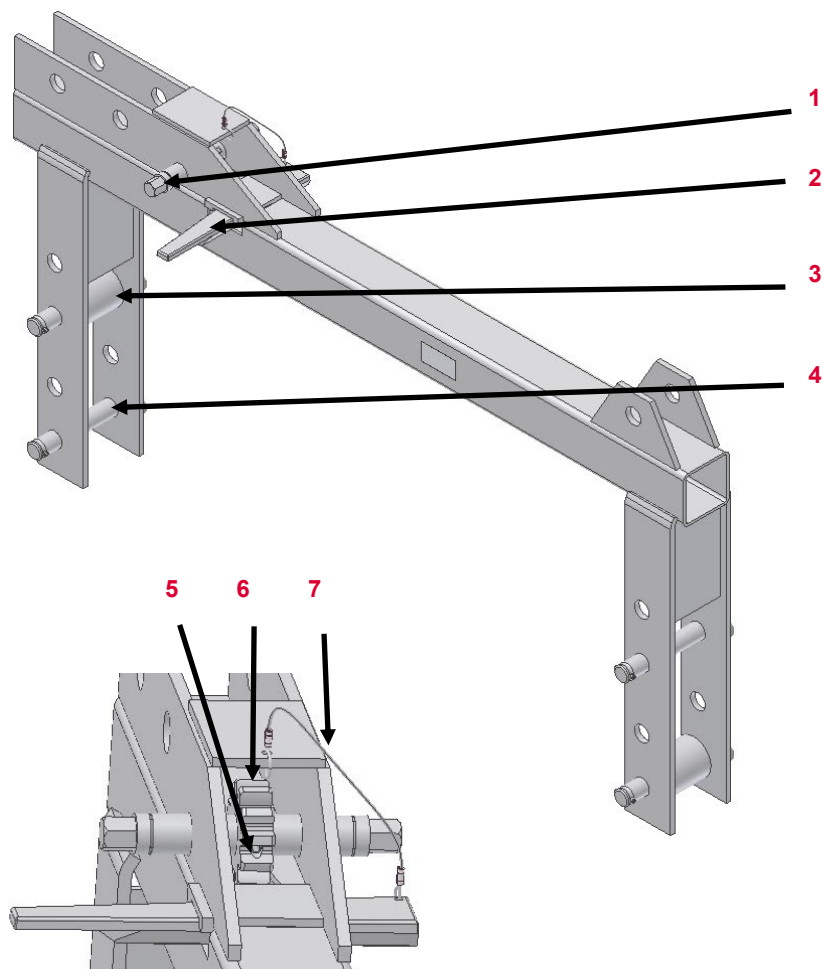

1	Tengely Ø 25 x 184	710859
2	Ék	710944
3	Mozgató kocsi görgő RD	711047
4	Csap feszítőhüvellyel	715936
5	Feszítőstift	710914
6	Fogaskerék	710866
7	Palást	127303

# PERI Bérleti kritériumok

## Függesztett állványok



Mozgató kocsi CB 240	Leírás	Instrukció	Fizetési kondíció	Típus
----------------------	--------	------------	-------------------	-------



### Lemezek hajlottak

- Ha lehetséges
- Vagy ha nem lehetséges

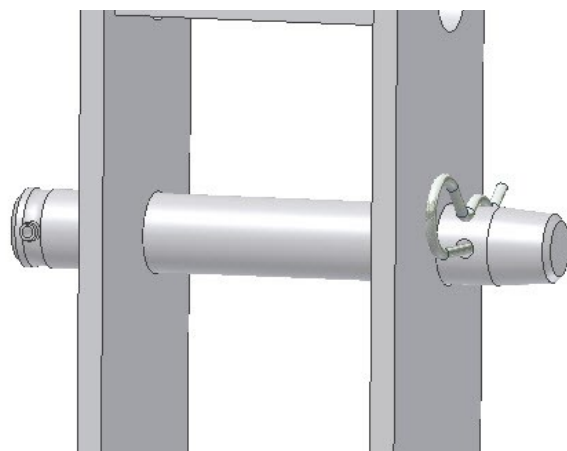

### Csap | Saszseg











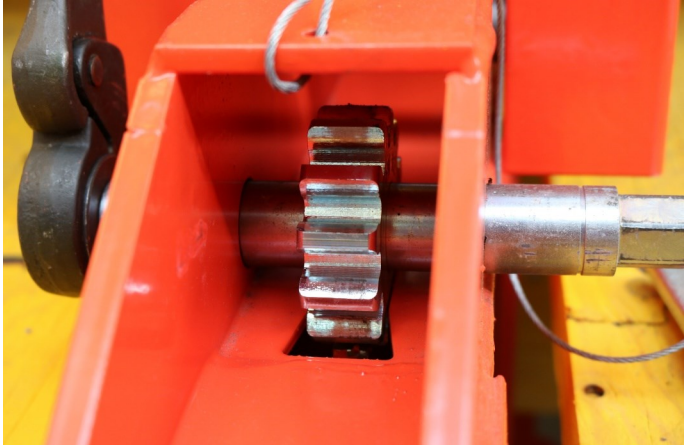



- Hiányzik
- Vagy sérült erőfeszítésből



# PERI Bérleti kritériumok

## Függesztett állványok



Mozgató kocsi CB 240	Leírás	Instrukció	Fizetési kondíció	Típus
	<p><b>Fogaskerék</b></p> <ul style="list-style-type: none"> <li>■ Kopott</li> <li>■ Sérült erőfeszítésből</li> </ul>	 	 	 
	<p><b>Ék</b></p> <ul style="list-style-type: none"> <li>■ Hiányzik</li> <li>■ Sérült erőfeszítésből</li> </ul>	 	 	 

# PERI Bérleti kritériumok

## Függesztett állványok



Fogasléc CB 240 (051040)	Leírás	Instrukció	Fizetési kondíció	Típus
	<b>Csap   Sasszeg</b>	018050 (Csap) 018060 (Sasszeg)		
	<ul style="list-style-type: none"> <li>■ Hiányzik</li> </ul>	018050 (Csap) 018060 (Sasszeg)		
	<b>Fogasléc</b>			
	<ul style="list-style-type: none"> <li>■ Kopott</li> </ul>			
<ul style="list-style-type: none"> <li>■ Sérült erőfeszítésből</li> </ul>				

# PERI Bérleti kritériumok

## Függesztett állványok



Emelőszem CB 240-2 (127821)	Leírás	Instrukció	Fizetési kondíció	Típus
-----------------------------	--------	------------	-------------------	-------

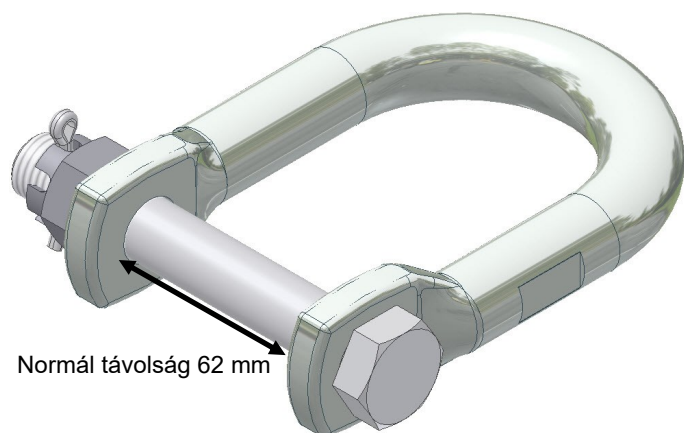

### Hajlott emelőszem

- Távolság > 64 mm (3%)
- Vagy a távolság < 60 mm (3%)

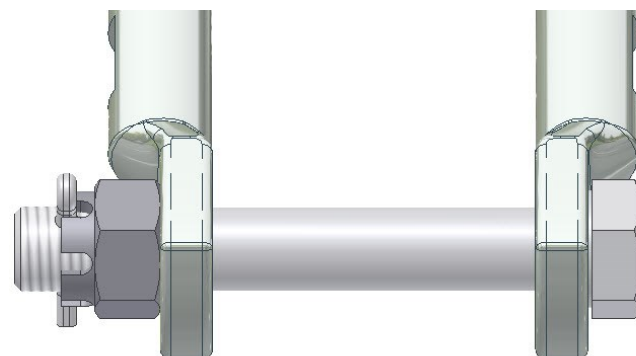

### Csavar | Bástya anya | Sasszeg

- hiányos
- Sérült erőfeszítésből
- Vagy kopott a csavar,  $\varnothing < 14.5$  mm (10%)



128335 (Csavar)  
126248 (Bástya anya)  
722825 (Sasszeg)

128335 (Csavar)  
126248 (Bástya anya)  
722825 (Sasszeg)

128335 (csavar)







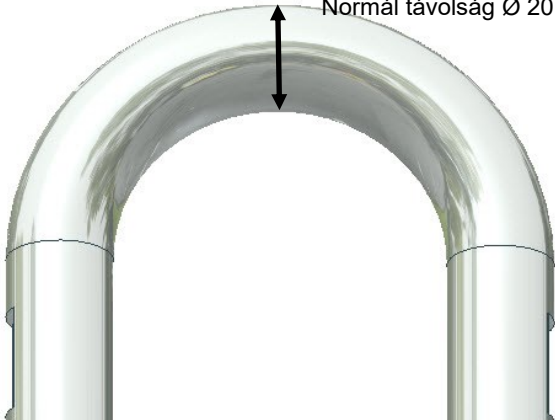

# PERI Bérleti kritériumok

## Függesztett állványok











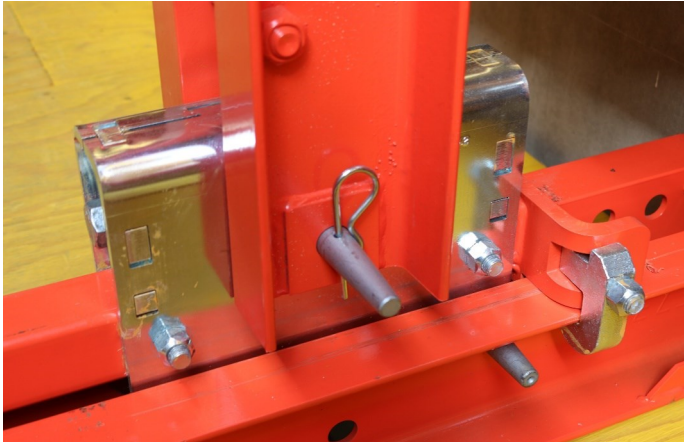

Emelőszem CB 240-2 (127821)	Leírás	Instrukció	Fizetési kondíció	Típus
 <p data-bbox="528 496 808 520">Normál távolság Ø 20 mm</p>	<p data-bbox="875 475 958 501"><b>Kopott</b></p> <ul data-bbox="875 568 1093 596" style="list-style-type: none"><li data-bbox="875 568 1093 596">■ &lt; Ø 18 mm (10%)</li></ul>			

# PERI Bérleti kritériumok

## Függesztett állványok











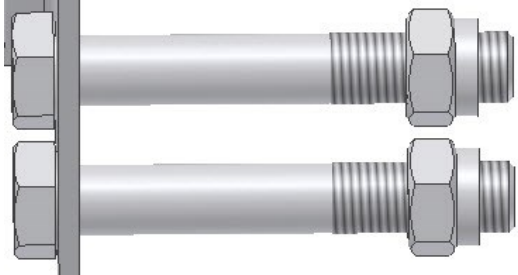





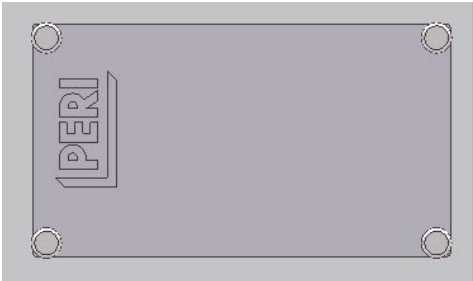

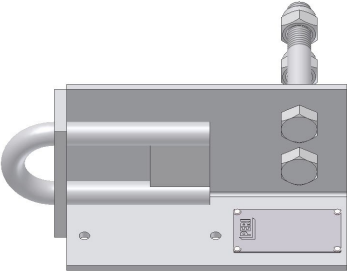

Feszítő egység CB 160 (051130)	Leírás	Instrukció	Fizetési kondíció	Típus
	<p>Nem funkcionál (nem mozgatható)</p>			
	<p><b>Csavar  Anya</b></p> <ul style="list-style-type: none"> <li>■ Hiányzik</li> <li>■ Sérült erőfeszítésből</li> </ul>	<div style="display: flex; align-items: center;">  <p>711084 (csavar M20 x 150) 781053 (anya)</p> </div> <div style="display: flex; align-items: center; margin-top: 10px;">  </div>		
				

# PERI Bérleti kritériumok

## Függesztett állványok











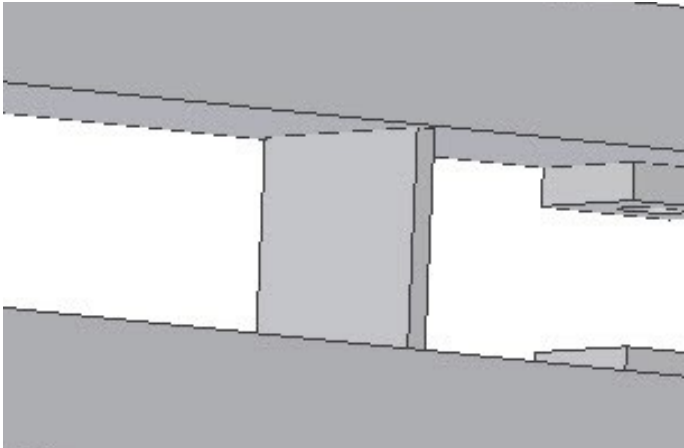

Munkaszint emelő CB 160 (051120)	Leírás	Instrukció	Fizetési kondíció	Típus
	<b>Csavar   Anya</b>			
	<ul style="list-style-type: none"> <li>■ Hiányzik</li> </ul>	 711078 (Csavar) 781053 (Anya)		
	<ul style="list-style-type: none"> <li>■ Vagy sérült erőfeszítésből</li> </ul>	 711078 (Csavar) 781053 (Anya)		
	<b>Típustábla</b>			
	<ul style="list-style-type: none"> <li>■ Hiányzik</li> </ul>	 127295 (Típustábla) 710217 (Szegecs)		
	<ul style="list-style-type: none"> <li>■ Vagy nem olvasható</li> </ul>	 127295 (Típustábla) 710217 (Szegecs)		
	<b>Hajlott</b>			
	<ul style="list-style-type: none"> <li>■ Ha lehetséges</li> </ul>			
	<ul style="list-style-type: none"> <li>■ Vagy ha nem lehetséges</li> </ul>			

# PERI Bérleti kritériumok

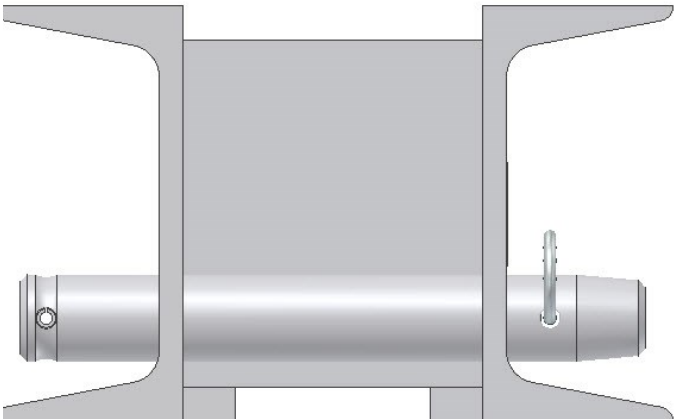
## Függesztett állványok













Függőleges heveder CB (051060; 051150)	Leírás	Instrukció	Fizetési kondíció	Típus
	<b>Merevítő lemez</b>			
	<ul style="list-style-type: none"> <li>■ Törött</li> <li>■ Vagy hiányzik</li> </ul>	<ul style="list-style-type: none"> <li>  701248 (Lemez)                 </li> <li>  701248 (Lemez)                 </li> </ul>	<ul style="list-style-type: none"> <li>  </li> <li>  </li> </ul>	<ul style="list-style-type: none"> <li>  </li> <li>  </li> </ul>
	<b>Csap   Sasszeg hiányzik</b>	<ul style="list-style-type: none"> <li>  715936 (Csap)                 </li> <li>  018060 (Sasszeg)                 </li> </ul>	<ul style="list-style-type: none"> <li>  </li> </ul>	<ul style="list-style-type: none"> <li>  </li> </ul>

# PERI Bérleti kritériumok

## Függesztett állványok





Függőleges heveder CB (051060; 051150)	Leírás	Instrukció	Fizetési kondíció	Típus
	<b>Hajlott</b>  ■ ≤ 5 mm (l/500)			
	■ Vagy > 5 mm (l/500)			
	<b>Rövidített   Bevágott</b>			

# PERI Bérleti kritériumok

## Függesztett állványok











VARIO magasság állító CB   SCS (051030)	Leírás	Instrukció	Fizetési kondíció	Típus
	<p><b>Rozsdás</b></p> <ul style="list-style-type: none"> <li>■ Az orsó funkcionál és a rozsdásodás osztálya &lt; D</li> <li>■ Vagy nem funkcionál</li> <li>■ Vagy rozstda osztálya D</li> </ul>	<p>✓</p> <p>🗑️</p>	<p>🚫</p> <p>🚫</p>	<p>👁️</p> <p>⚙️</p>
	<p><b>Csavar   Sasszeg   Orsó hiányzik</b></p>	<p>🔧</p> <p>106776 (Orsó) 715936 (Csap) 018060 (Sasszeg)</p>	<p>🚫</p>	<p>⚙️</p>



# PERI Bérleti kritériumok

## Függesztett állványok













Faltámasz CB 164-224 (051110)	Leírás	Instrukció	Fizetési kondíció	Típus
	Törött foggantyú	 117471 (Foggantyú)		
	Koszoró orsó	 Zsírozó (727105)		

# PERI Bérleti kritériumok

## Függesztett állványok



Faltámasz CB 164-224 (051110)	Leírás	Instrukció	Fizetési kondíció	Típus
	<b>Rozsdás</b> <ul style="list-style-type: none"> <li>■ Rozsda osztálya &lt;D és nem funkcionál</li> </ul>	 Rozsda eltávolítása és zsírozása		
	<ul style="list-style-type: none"> <li>■ Vagy rozsda osztálya D</li> <li>■ Vagy nem funkcionál</li> </ul>			
	<b>Csap   Sasszeg hiányzik</b>	 715936 (Csap) 018060 (Sasszeg)		

# PERI Bérleti kritériumok

## Függesztett állványok



Csatlakozó TRIO-CB (051090)	Leírás	Instrukció	Fizetési kondíció	Típus	
	Orsó				
	■ Hiányzik				106776 (Orsó)
	■ Vagy sérült erőfeszítéstől (nem funkcionál)				106776 (Orsó)
■ Vagy a funkció miatt kopott		106776 (Orsó)			
Csap   U- Csap   Sasszeg hiányos					711115 (U- Csap)
715936 (Csap)					
018060 (Sasszeg)					

# PERI Bérleti kritériumok

## Függesztett állványok



SKS Lekötés U100 - U120 (110059)	Leírás	Instrukció	Fizetési kondíció	Típus
----------------------------------	--------	------------	-------------------	-------

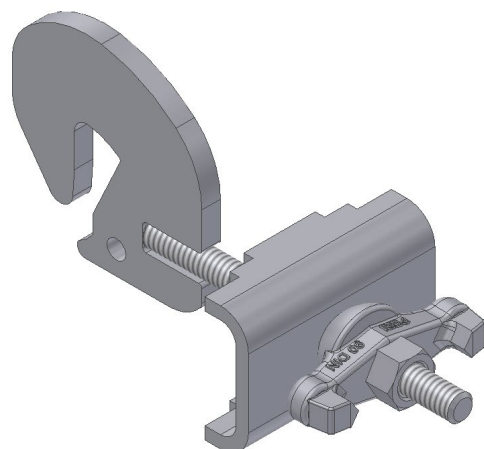

### Nem funkcionál

- Kopás miatt
- Vagy sérült erőfeszítéstől



### Kereszt fogó | Gömbös anya

- Hiányzik



110055 (Kereszt fogó)  
118260 (Gömbös anya)



# PERI Bérleti kritériumok

## Függesztett állványok



Munkaszint CB (051230)	Leírás	Instrukció	Fizetési kondíció	Típus
	<b>Lemez hajlott</b>			
	<ul style="list-style-type: none"> <li>■ Ha lehetséges</li> </ul>			
	<b>Csavar   Anya hiányzik</b>			
		710232 (csavar) 070890 (anya)		

# PERI Bérleti kritériumok

## Függesztett állványok



Toldó rúd CB 225 (051200)	Leírás	Instrukció	Fizetési kondíció	Típus
---------------------------	--------	------------	-------------------	-------



Hajlott

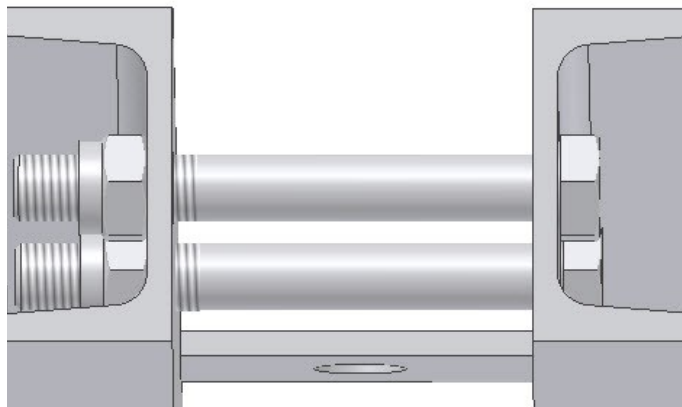

Csavar | Anya hiányzik



710232 (csavar)  
070890 (anya)











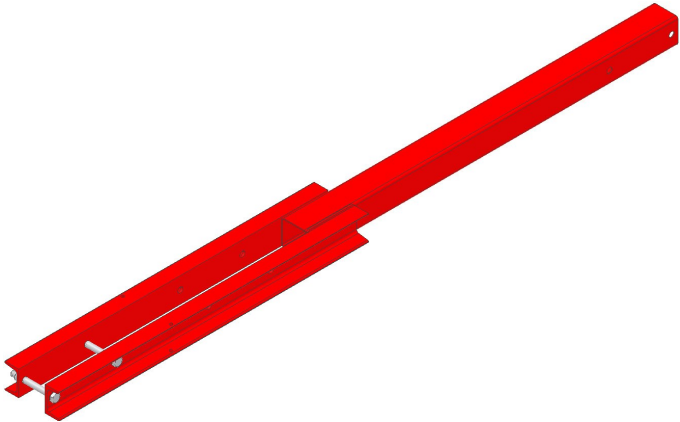

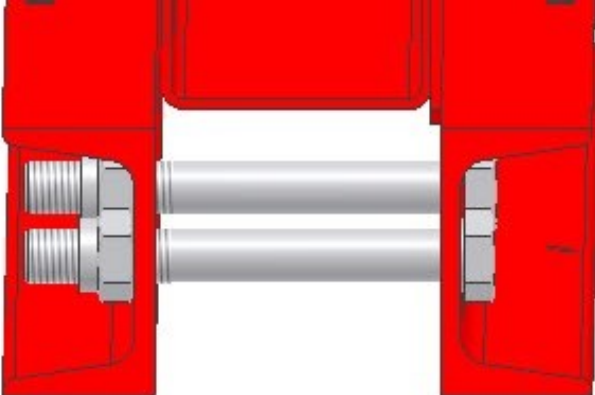

# PERI Bérleti kritériumok

## Függesztett állványok











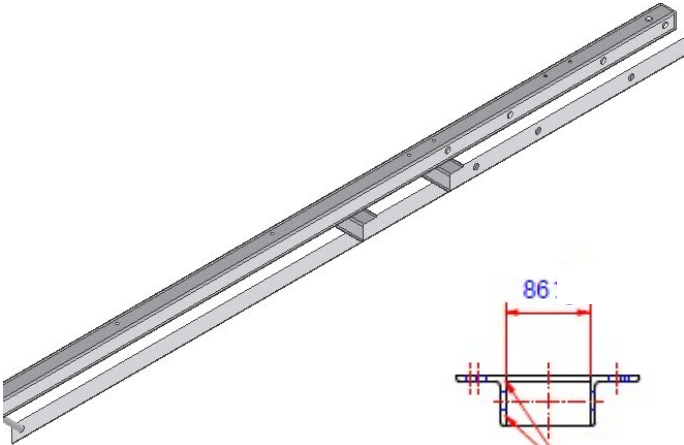

Heveder toldó CB (051050)	Leírás	Instrukció	Fizetési kondíció	Típus
	<b>Hajlott oszlop</b>	 	 	 
	<ul style="list-style-type: none"> <li>■ Ha lehetséges</li> </ul>			
	<b>Csavar   Anya hiányzik</b>			
		710232 (csavar) 070890 (anya)		

# PERI Bérleti kritériumok

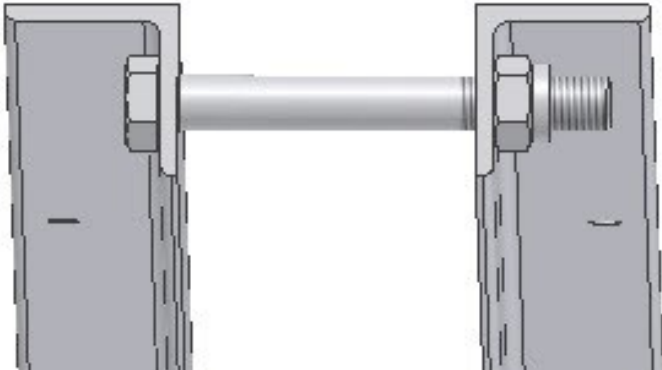
## Függesztett állványok













Korláttartó CB 200 (051190)	Leírás	Instrukció	Fizetési kondíció	Típus
	<p><b>Hajlott</b></p> <ul style="list-style-type: none"> <li>■ Ha lehetséges</li> <li>■ Vagy ha nem lehetséges</li> </ul>	  	  	  
	<p><b>Csavar   Anya hiányzik</b></p>	 <p>710232 (csavar) 070890 (anya)</p>		

# PERI Bérleti kritériumok

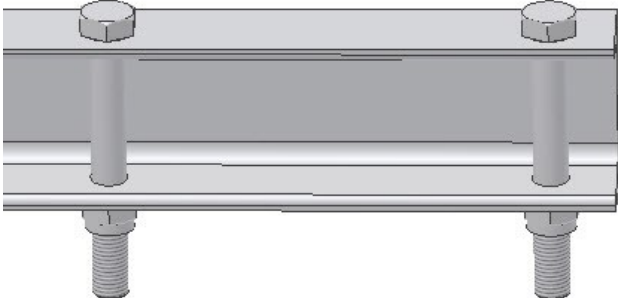
## Függesztett állványok



Korláttartó CB (051210   051220)	Leírás	Instrukció	Fizetési kondíció	Típus
	<p><b>Hajlott</b></p> <ul style="list-style-type: none"> <li>■ Ha lehetséges</li> <li>■ Vagy ha nem lehetséges</li> </ul>	  	  	  
	<p><b>Csavar   Anya hiányzik</b></p>	 <p>710232 (csavar) 070890 (anya)</p>		

# PERI Bérleti kritériumok

## Függesztett állványok











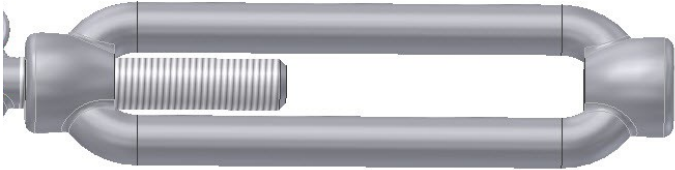





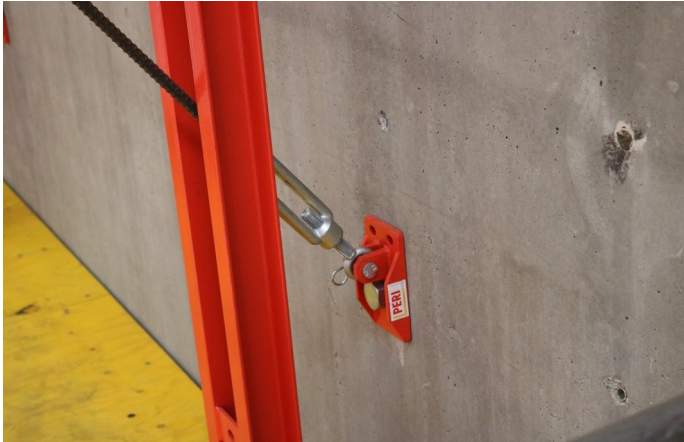

Függőleges heveder CB 270 (051610)	Leírás	Instrukció	Fizetési kondíció	Típus
	<b>Lemez hajlott</b>	<ul style="list-style-type: none"> <li>■ Ha lehetséges</li> </ul>		
	<ul style="list-style-type: none"> <li>■ Vagy ha nem lehetséges</li> </ul>			
	<b>Korlát hajlott</b>	<ul style="list-style-type: none"> <li>■ Ha lehetséges</li> </ul>		
	<ul style="list-style-type: none"> <li>■ Vagy ha nem lehetséges</li> </ul>			

# PERI Bérleti kritériumok

## Függesztett állványok



Visszakötés-talp (107008)	Leírás	Instrukció	Fizetési kondíció	Típus
	<b>Feszítőzár</b> <ul style="list-style-type: none"> <li>■ Hiányzik</li> </ul>	 711059 (feszítőzár)		
	<ul style="list-style-type: none"> <li>■ Vagy sérült erőfeszítésből</li> </ul>	 711059 (feszítőzár)		
	<ul style="list-style-type: none"> <li>■ Vagy nem mozgatható rozsdá miatt</li> </ul>			
	<b>Szemescsavar   Csap   Sasszeg</b> <ul style="list-style-type: none"> <li>■ Hiányzik</li> </ul>	 711060 (Szemescsavar) 027170 (Csap) 018060 (Sasszeg)		
	<ul style="list-style-type: none"> <li>■ Vagy sérült erőfeszítésből</li> </ul>	 711060 (Szemescsavar) 027170 (Csap) 018060 (Sasszeg)		

# PERI Bérleti kritériumok

## Függesztett állványok



Visszakötés   Feszítő heveder csatlakozó	Leírás	Instrukció	Fizetési kondíció	Típus
--	--------	------------	-------------------	-------

(051260 | 107007)

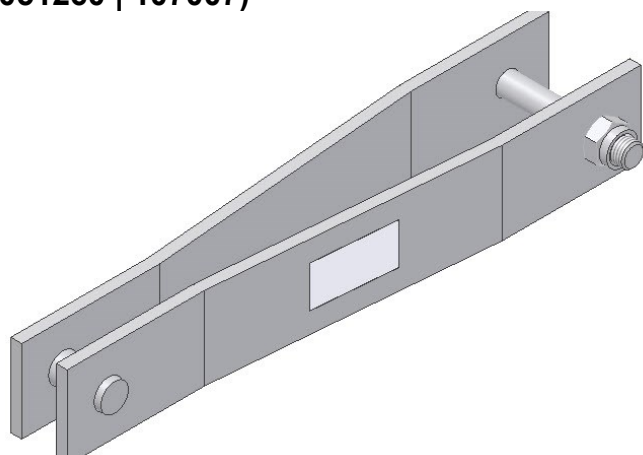

### Hajlott

- Ha lehetséges
- Vagy ha nem lehetséges

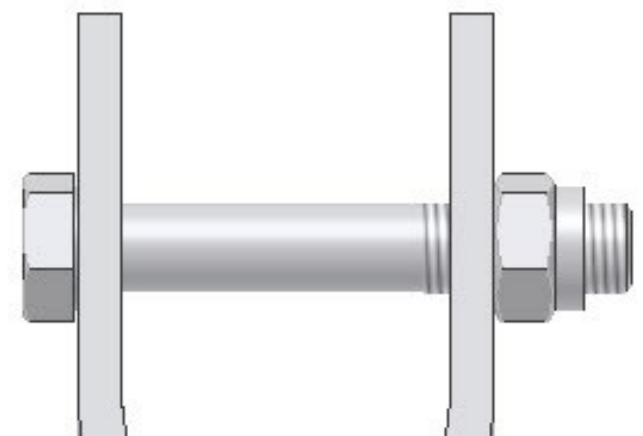

### Csavar | Anya hiányzik



710219 (csavar)  
070890 (anya)





# PERI Bérleti kritériumok

## Függesztett állványok



VARIO Betonozó konzol (027110   027060   027070)	Leírás	Instrukció	Fizetési kondíció	Típus
--	--------	------------	-------------------	-------

027070)



### Hajlott

■ ≤ 5 mm



■ Vagy > 5 mm



### Repedés a hegesztésben

■ Sérülés nélkül az anyagban











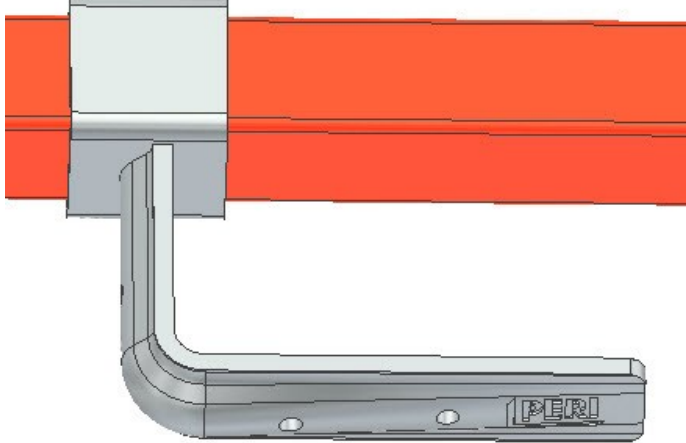

■ Vagy sérülés van az anyagban

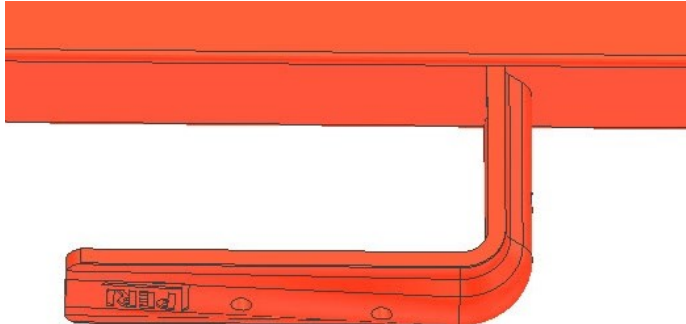

# PERI Bérleti kritériumok

## Függesztett állványok



VARIO Betonozó konzol GB 80 (027110   102926)	Leírás	Instrukció	Fizetési kondíció	Típus
	<p><b>Csúszó darab</b></p> <ul style="list-style-type: none"> <li>■ Hiányzik</li> <li>■ Vagy sérült erőfeszítésből</li> </ul>	<p> 115673 (csúszó darab)</p> <p> 115673 (csúszó darab)</p>	<p></p> <p></p>	<p></p> <p></p>
	<p><b>L- Szög hajlott vagy törött</b></p>	<p> 115543 (L- Szög)</p>	<p></p>	<p></p>

# PERI Bérleti kritériumok

## Függesztett állványok













VARIO Betonozó konzol GB 80 (027110	Leírás	Instrukció	Fizetési kondíció	Típus
102926)	Biztosító fül			
	<ul style="list-style-type: none"> <li>■ Hlányzik</li> </ul>	 715144 (Biztosító fül)		
	<ul style="list-style-type: none"> <li>■ Vagy hajlott</li> </ul>	 715144 (Biztosító fül)		

# PERI Bérleti kritériumok

## Függesztett állványok











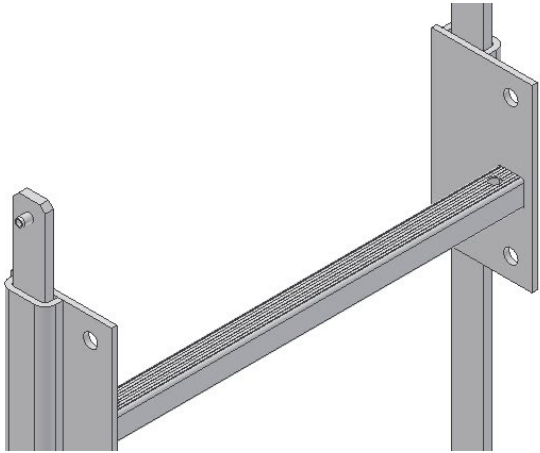

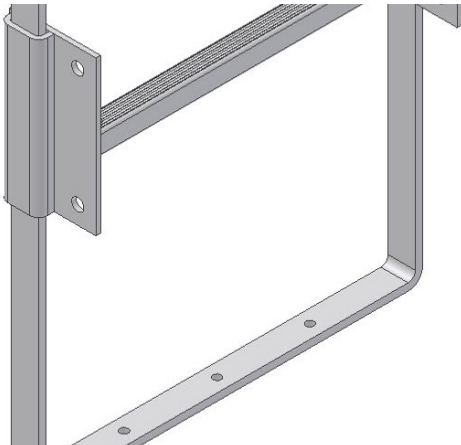

Létra 180   220 (051410   051420)	Leírás	Instrukció	Fizetési kondíció	Típus
	<b>Létra foka hajlott</b> <ul style="list-style-type: none"> <li>■ A hegesztés sérülése nélkül</li> <li>■ Vagy a hegesztés sérült</li> </ul>	 	 	 
	<b>Csavar   Anya hiányzik</b>	 710224 (csavar) 710381 (anya)		

# PERI Bérleti kritériumok

## Függesztett állványok



Létra horg. (109105)	Leírás	Instrukció	Fizetési kondíció	Típus
	<b>Létrafok hajlott</b> <ul style="list-style-type: none"> <li>■ A hegesztés sérülése nélkül</li> </ul>			
	<ul style="list-style-type: none"> <li>■ Vagy a hegesztés sérült</li> </ul>	 109104 (Létrafok)		
	<b>Keret hajlott</b> <ul style="list-style-type: none"> <li>■ Ha lehetséges</li> </ul>			
	<ul style="list-style-type: none"> <li>■ Vagy ha nem lehetséges</li> </ul>	 109102 (Létrafok)		

# PERI Bérleti kritériumok

## Függesztett állványok















Létra talp (051460)	Leírás	Instrukció	Fizetési kondíció	Típus
	<b>Hajlott</b>			
	■ Ha lehetséges			
	■ Vagy ha nem lehetséges			



# PERI Bérleti kritériumok

## Függesztett állványok











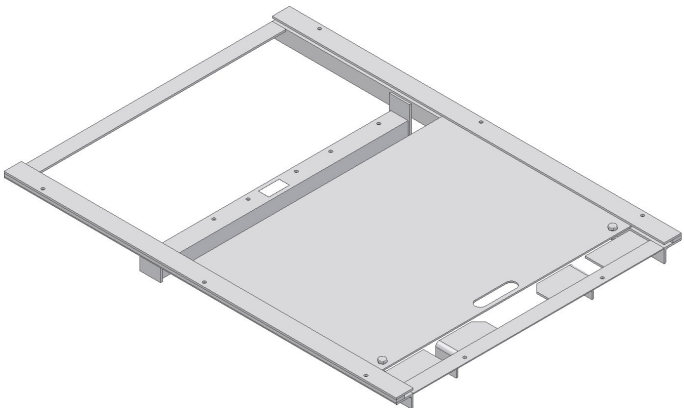





SKS Lekötés (051080)	Leírás	Instrukció	Fizetési kondíció	Típus
	<b>Szárnyasanya   T- Csavar   Összefogó</b>	 710264 (Szárnyasanya) 710263 (T- Csavar) 722137 (összefogó)		
	<ul style="list-style-type: none"> <li>■ Hajlott</li> </ul>			
	<b>Kampó</b>	 710188 (jobb kampó) 710186 (bal kampó)		
	<ul style="list-style-type: none"> <li>■ Hlányzik</li> </ul>	 710188 (jobb kampó) 710186 (bal kampó)		
<ul style="list-style-type: none"> <li>■ Vagy hajlott</li> </ul>				

# PERI Bérleti kritériumok

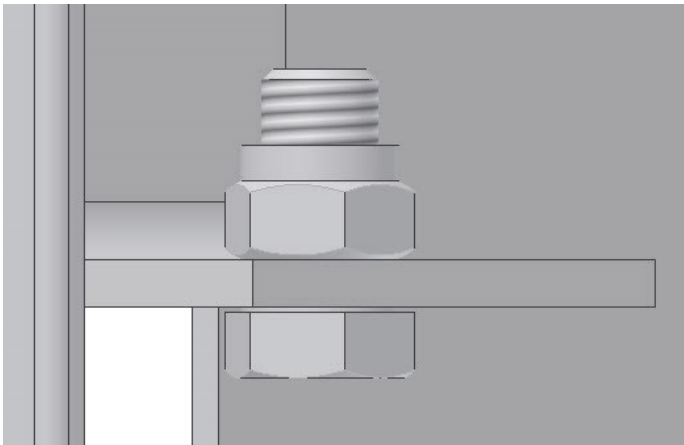
## Függesztett állványok



Létra ajtó (051430)	Leírás	Instrukció	Fizetési kondíció	Típus	
	<p><b>Ajtó hajlott</b></p> <ul style="list-style-type: none"> <li>■ Ha lehetséges és utána mozgatható</li> </ul>				
	<ul style="list-style-type: none"> <li>■ Vagy ha nem lehetséges</li> </ul>		701283 (Nyllás)		
	<ul style="list-style-type: none"> <li>■ Vagy törött az anyag</li> </ul>		701283 (Nyllás)		
	<p><b>Csavar   Anya hiányzik</b></p>		710266 (Csavar) 710381 (Anya)		

# PERI Bérleti kritériumok

## Függesztett állványok



### Munkaállvány ASG (105843 | 105844)

Sorszám	Megnevezés	Cikkszám
---------	------------	----------

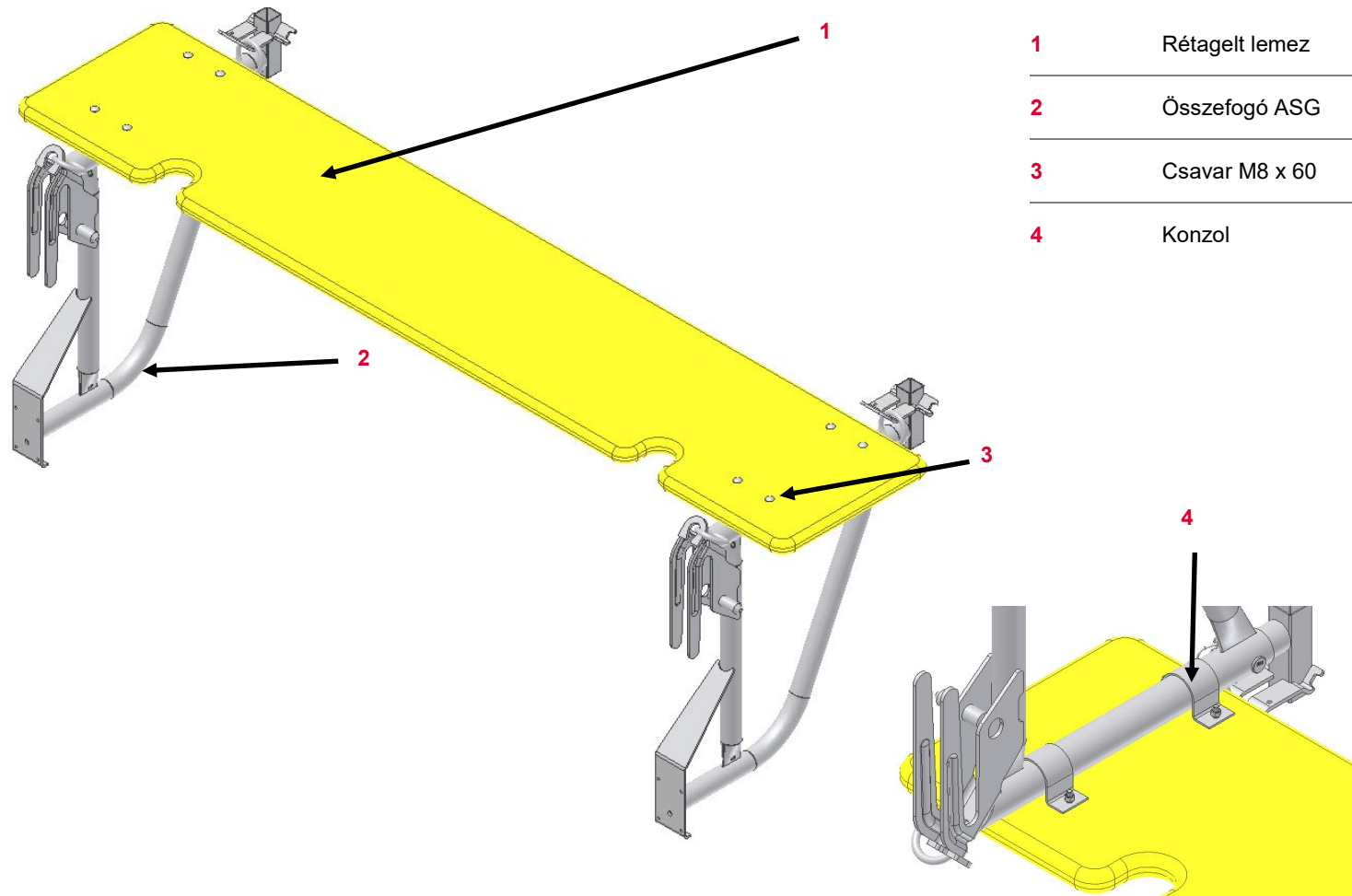



1	Rétagelt lemez	
2	Összefogó ASG	105845
3	Csavar M8 x 60	710326
4	Konzol	105907

# PERI Bérleti kritériumok

## Függesztett állványok



Munkaállvány ASG	Leírás	Instrukció	Fizetési kondíció	Típus
 <p>286.23.01a Schichtholzplatte erneuern</p>	<p><b>Sarkán sérült rétegelt lemez</b></p> <ul style="list-style-type: none"> <li>■ ≤ 3 cm</li> <li>■ Vagy &gt; 3 cm</li> </ul>	<p>Ne jelentsen botlásveszélyt</p> <p>105842 (70-100 x 240) 105841 (70-100 x 248)</p>	<p>[Icon: Three horizontal lines]</p> <p>[Icon: Three horizontal lines]</p>	<p>[Icon: Green gear]</p> <p>[Icon: Green gear]</p>
	<p><b>Vágások   Hasadás</b></p> <ul style="list-style-type: none"> <li>■ ≤ 3 cm</li> <li>■ Vagy &gt; 3 cm</li> </ul>	<p>Ne jelentsen botlásveszélyt</p> <p>105842 (70-100 x 240) 105841 (70-100 x 248)</p>	<p>[Icon: Three horizontal lines]</p> <p>[Icon: Three horizontal lines]</p>	<p>[Icon: Green gear]</p> <p>[Icon: Green gear]</p>
 <p>298.20.03a Schichtholzplatte beschädigt</p>				

# PERI Bérleti kritériumok

## Függesztett állványok









Munkaállvány ASG	Leírás	Instrukció	Fizetési kondíció	Típus
	<b>Furatok</b>			
	<ul style="list-style-type: none"> <li>■ <math>\leq \text{Ø } 20 \text{ mm}</math> és max. <math>1 / \text{m}^2</math></li> </ul>	<p>105842 (70-100 x 240) 105841 (70-100 x 248)</p>		
	<ul style="list-style-type: none"> <li>■ Vagy <math>&gt; \text{Ø } 20 \text{ mm}</math></li> </ul>	<p>105842 (70-100 x 240) 105841 (70-100 x 248)</p>		
	<b>Rétegelt lemez</b>	<p>105842 (70-100 x 240) 105841 (70-100 x 248)</p>		

# PERI Bérleti kritériumok

## Függesztett állványok



Munkaállvány ASG	Leírás	Instrukció	Fizetési kondíció	Típus						
	<b>Rétegelt lemez elhajlott</b>									
	<ul style="list-style-type: none"> <li>■ <math>\leq</math> megengedett hajlás (l/100)</li> </ul>									
	<ul style="list-style-type: none"> <li>■ Vagy <math>&gt;</math> megengedett hajlás</li> </ul>									
	<table border="1"> <thead> <tr> <th>Cikk</th> <th>Megengedett hajlás</th> </tr> </thead> <tbody> <tr> <td>Munkaállvány ASG 240</td> <td>25 mm</td> </tr> <tr> <td>Munkaállvány ASG 298</td> <td>30 mm</td> </tr> </tbody> </table>	Cikk	Megengedett hajlás	Munkaállvány ASG 240	25 mm	Munkaállvány ASG 298	30 mm			
Cikk	Megengedett hajlás									
Munkaállvány ASG 240	25 mm									
Munkaállvány ASG 298	30 mm									



# PERI Bérleti kritériumok

## Függesztett állványok



Konzol ASG (105845)	Leírás	Instrukció	Fizetési kondíció	Típus
	<b>A korlátozószlop csatlakozása hajlott</b>	<ul style="list-style-type: none"> <li>■ Használható</li> </ul>		
	<ul style="list-style-type: none"> <li>■ Vagy nem illeszthető</li> </ul>	<ul style="list-style-type: none"> <li>106184 (Korlátozószlop csatlakozása)</li> <li>106031 (csap)</li> <li>018060 (sasszeg)</li> </ul>		
	<b>Konzol elhajlott</b>	<ul style="list-style-type: none"> <li>■ Ha lehetséges</li> </ul>		
	<ul style="list-style-type: none"> <li>■ Ha nem lehetséges</li> </ul>			

# PERI Bérleti kritériumok

## Függesztett állványok



### Munkaállvány ASG 160/240 (026580)

Sorszám	Megnevezés	Cikkszám
---------	------------	----------

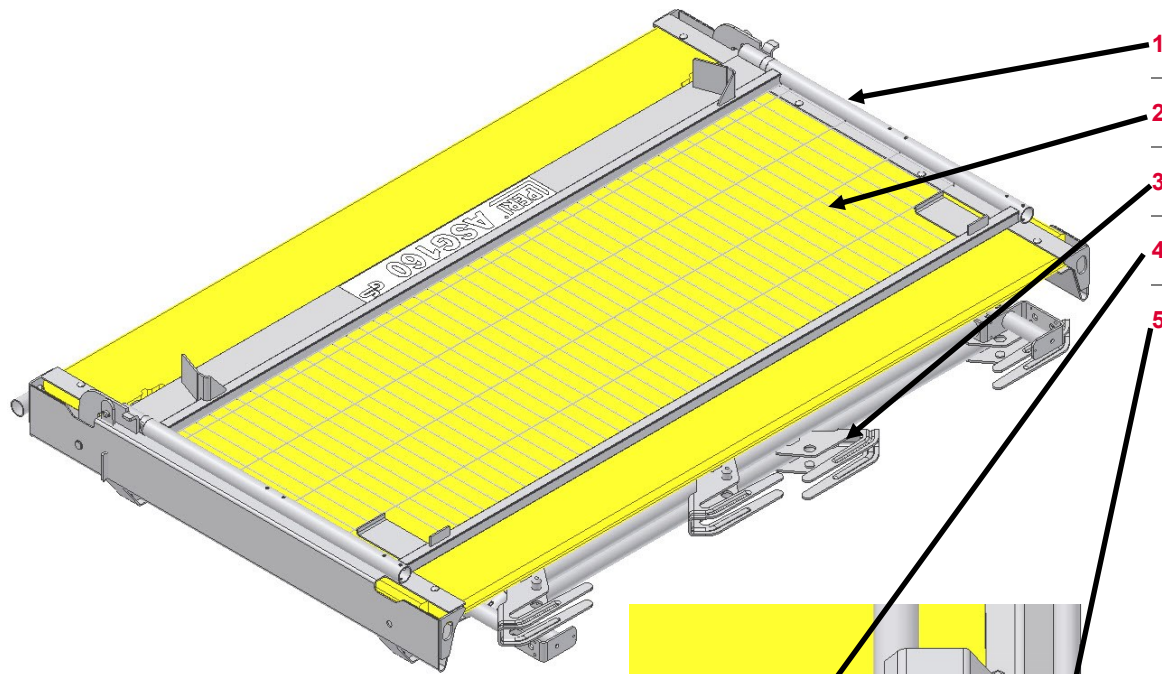

1	Rétegelt lemez ASG	716223
2	Hátsó kapaszkodó rész	101805
3	Akaszó ASG 160	026520
4	Biztonsági zár	710680
5	Csap	710682

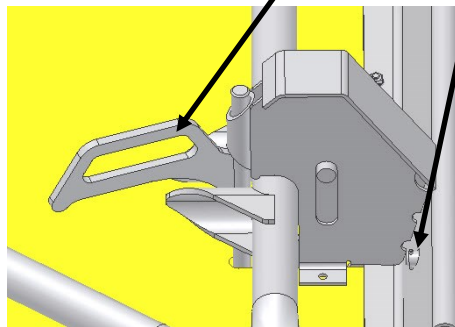

# PERI Bérleti kritériumok

## Függesztett állványok



Munkaállvány ASG 160/240	Leírás	Instrukció	Fizetési kondíció	Típus
--------------------------	--------	------------	-------------------	-------



Háló törött (kapaszkodó rész)

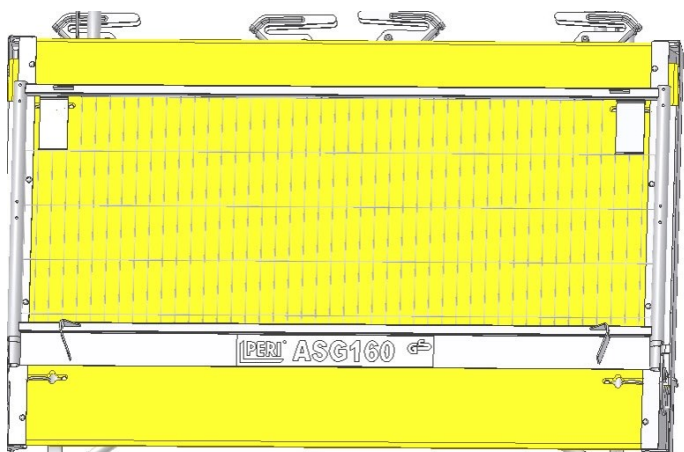

Rétegelt lemez

■ Sérülés > 3 cm



■ Vagy kopott



■ Vagy hajlott > 25 mm (l/100)



# PERI Bérleti kritériumok

## Függesztett állványok



### Üreges falfelfüggesztés (108870)

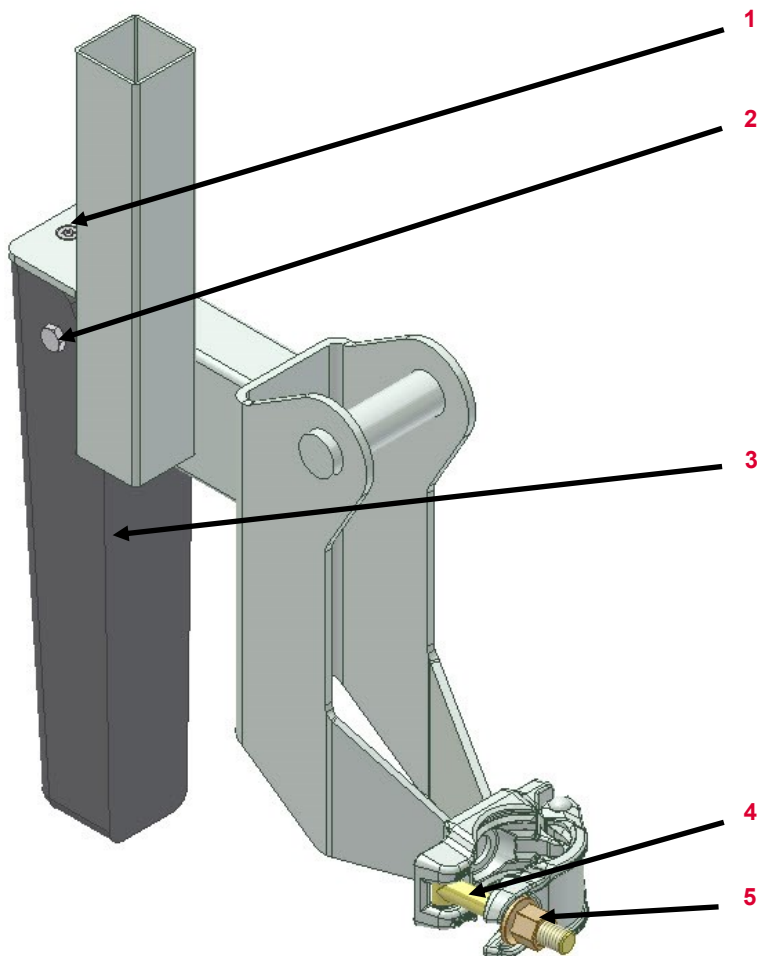









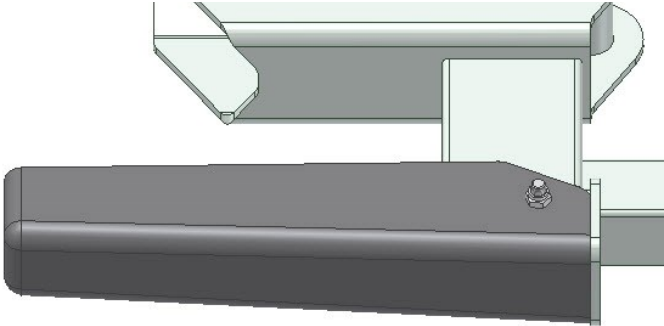

Sorszám	Megnevezés	Cikkszám
1	Csavar süllyesztős	021770
2	Csavar	108900
3	Borítás	108869
4	Kalapácsfejű csavar	131316
5	Anya	710340

# PERI Bérleti kritériumok

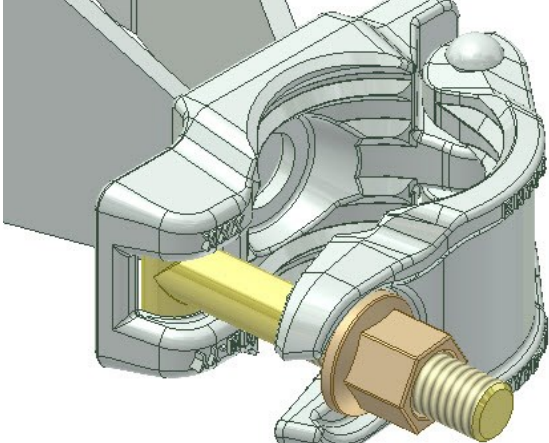
## Függesztett állványok















Üreges falfüggesztés	Leírás	Instrukció	Fizetési kondíció	Típus
	<p><b>Borítás</b></p> <ul style="list-style-type: none"> <li>■ Hiányzik</li> <li>■ Vagy erőszak miatt sérült</li> </ul>	  	  	  
	<p><b>Kalapácsfejű csavar   Anya hiányzik</b></p>			

# PERI Bérleti kritériumok

## Magyarázat



Ikon	Jelentés	Ikon	Jelentés	Ikon	Jelentés
	Nem OK—kiselejtezendő		Ügyfélnek leszámházandó		Optikai kár
	OK— marad bérleti parkban		Nincs számlázás		Funkcionális sérülés
	Selejt anyag – biztonsági okokból az anyagot tilos kiadni		Anyagot levágni		Funkcionális sérülés — anyag kiadása nem engedélyezett
	Javítás az előírások szerint		Anyagot megjelölni		Statikai sérülés — anyag kiadása nem engedélyezett
	Hideg egyengetés — utána a varratokat és a környékét ellenőrzni kell		Sérült anyag cseréje		
	Javítás gazdaságosság függvényében		Hiányzó anyag pótlása		
	Megtisztítani az anyagot				