

PERI Bérleti kritérium

PERI UP Alaptermékek



Kapcsolat

**PERI Kft,
Zsaluzatok, állványzatok,
mérnöki szolgáltatás**

H-1181 Budapest
Zádor u. 9.
Tel.: +36-1-296-09-60

Tartalom	oldal
Acél járótábla UDI /UDG/ UDG-2	2
Létrás feljáró UAL	8
Vízszintes heveder UH És UH Plusz illetve UH-2 Plusz	11
Alaprúd, Rúdelem, Zárórúd	16
Csavarostalp	18
Merevítők	24
Tartozékok	32
Létrás feljáró UAA és UAW	45
Tartalomjegyzék	52

Módosítások	Dátum által	oldal
Új verzió	02/17 ol	
Deck UAA és UAW hozzáadva	01/19 fw	45

PERI Bérleti kritérium

PERI UP Alaptermékek



Ipari Járótábla UDI | UDG

Sorsz.	Leírás	Cikkszám
--------	--------	----------

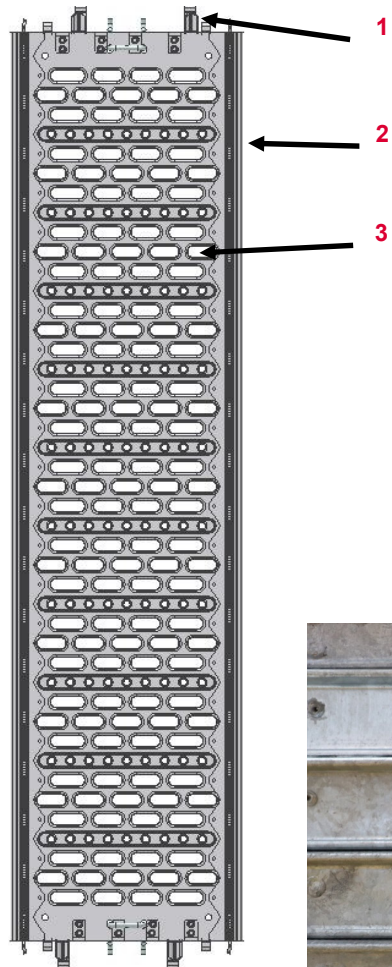

- | | |
|---|---------------|
| 1 | Rögzítő Fülek |
| 2 | Oldalprofil |
| 3 | Járófelület |

Oldalprofil furatokkal, UDG



Oldalprofil furatok nélkül, UDI



PERI Bérleti kritérium

PERI UP Alaptermékek



Megnevezés	Cikkszám
UDI 37,5x50	111685
UDI 37,5x75	111687
UDI 37,5x100	111686
UDI 37,5x125	111860
UDI 37,5x150	111863
UDI 37,5x200	111864
UDI 37,5x250	111865
UDI 37,5x300	111969
UDI 25x50	104029
UDI 25x75	105925
UDI 25x100	106092
UDI 25x125	106880
UDI 25x150	107002

Megnevezés	Cikkszám
UDI 25x200	108380
UDI 25x250	108540
UDI 25x300	108689
Acél Járótábla UDG 25 x 50	124124
Acél Járótábla UDG 25 x 75	124121
Acél Járótábla UDG 25 x 100	124118
Acél Járótábla UDG 25 x 125	124115
Acél Járótábla UDG 25 x 150	124112
Acél Járótábla UDG 25 x 200	124109
Acél Járótábla UDG 25 x 250	123771
Acél Járótábla UDG 25 x 300	124915

UDI UDG	Leírás	Instrukció	Fizetési kondíció	Típus
-----------	--------	------------	-------------------	-------



33.10.01 Oldalprofil elhajlott

- A járótábla behelyezhető és Tox- kapcsolat nem sérült
- Ha nem behelyezhető
- Ha Tox- kapcsolat sérült



33.10.02 Járótábla elhajlott

- $> l/100$
- $Or > 15 \text{ mm}$

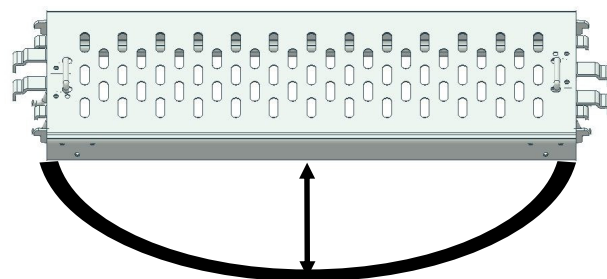

Hossz	/ Hajlás
50	5,0 mm
75	7,5 mm
100	10 mm
125	12,5 mm
150; 200; 250; 300	15,0 mm

PERI Bérleti kritérium

PERI UP Alaptermékek



UDI UDG	Leírás	Instrukció	Fizetési kondíció	Típus
-----------	--------	------------	-------------------	-------



33.10.03 Vágás a profilban

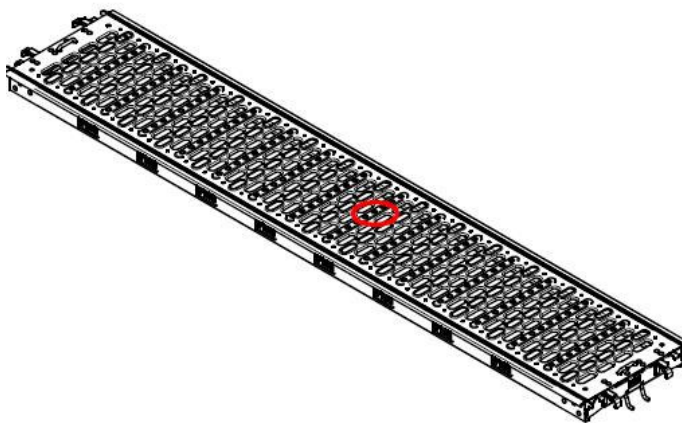

33.10.04 Lyuk a járófelületen











■ > Ø 25 mm

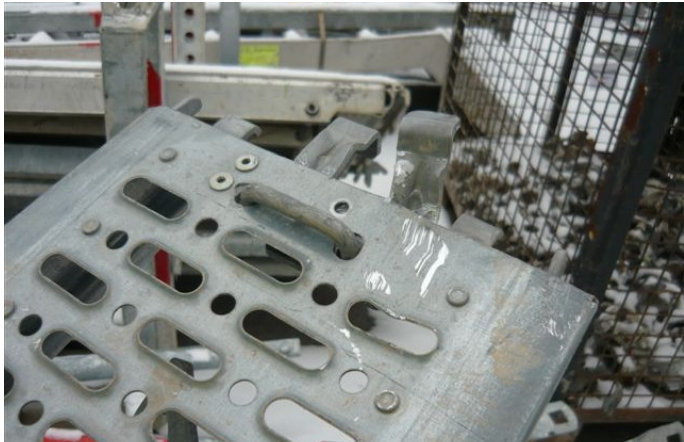

PERI Bérleti kritérium

PERI UP Alaptermékek



UDI UDG	Leírás	Instrukció	Fizetési kondíció	Típus
	<p>33.10.05 Repedés a rögzítő fülben</p> <ul style="list-style-type: none"> ■ UDG, UDG-2 és UDI esetében is 			
	<p>33.10.06 Rögzítő fül elhajlott UDG,UDG-2 és UDI</p> <ul style="list-style-type: none"> ■ Repedés nélkül, az elhajlás ≤ 5 mm ■ Vagy az elhajlás > 5 mm 			
				

PERI Bérleti kritérium

PERI UP Alaptermékek



UDI UDG	Leírás	Instrukció	Fizetési kondíció	Típus
	<p>33.10.07 Tartó fül elhajlott</p> <ul style="list-style-type: none">■ Anyag repedése nélkül■ Vagy anyag repedésével	 	 	 

PERI Bérleti kritérium

PERI UP Alaptermékek



Feljáró UAL-3

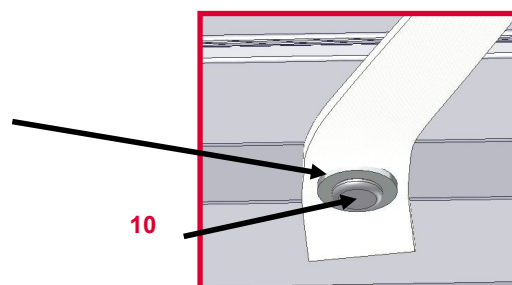
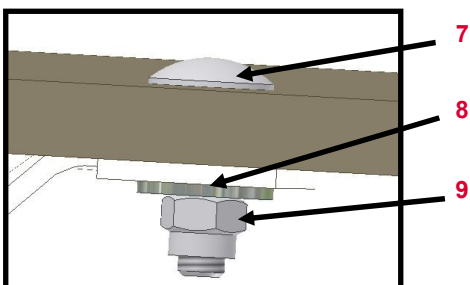
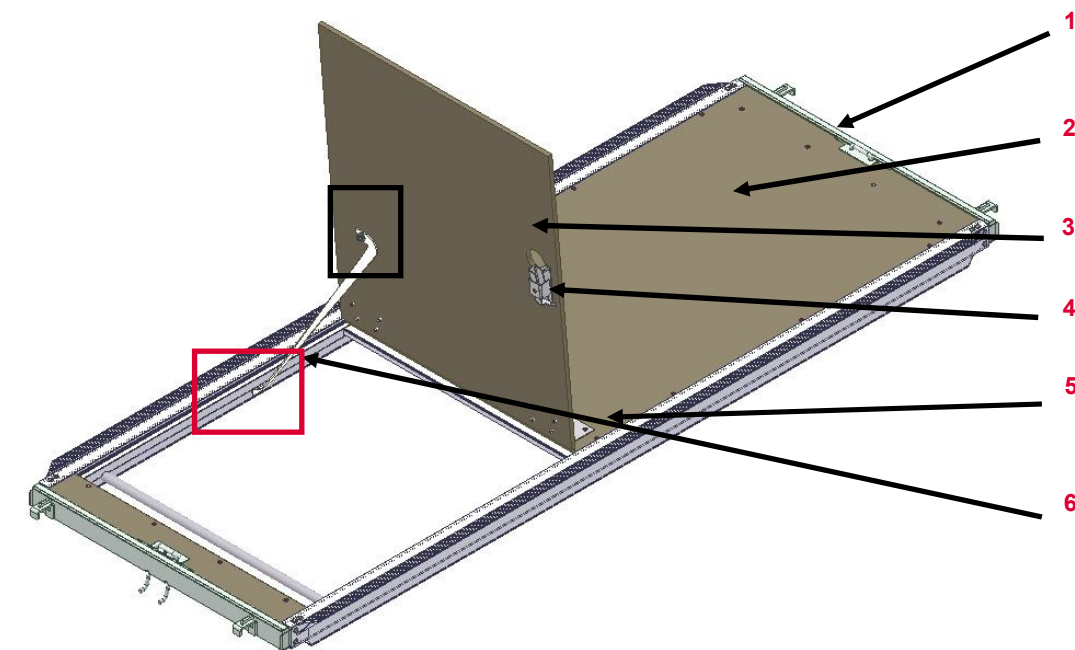









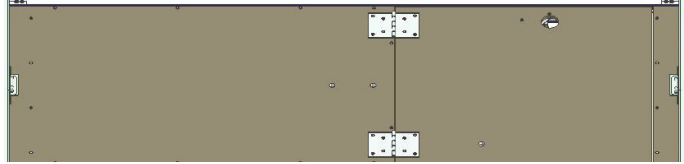

Sorsz.	Leírás	Cikkszám
1	Rögzítő UAL	128329
2	Rétegelt Lemez járólap	
3	Rétegelt Lemez ajtó UAL 75	126303
4	Zár UAL	115566
5	Zsanér	128319
6	Műanyag gátló	127472
7	Csavar M 6 x 25	127348
8	Alátét	127036
9	M 6 önzáró anya	129396
10	Szegecs	127334

Megnevezés	Cikkszám
Feljáró UAL-3 75x150/3	126393
Feljáró UAL-3 75x200/3	126392
Feljáró UAL-3 75x250/3	126314

PERI Bérleti kritérium

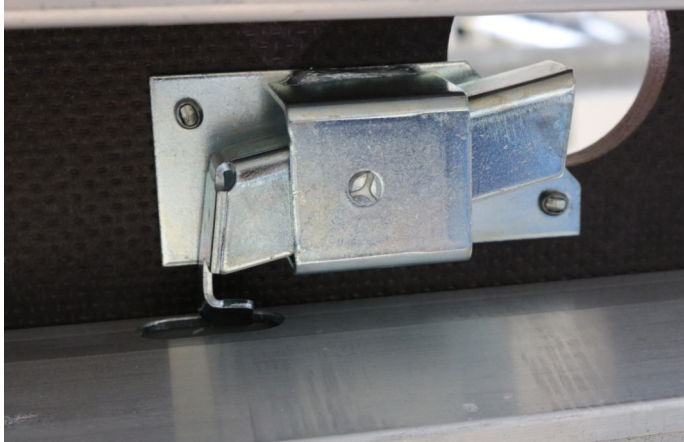
PERI UP Alaptermékek











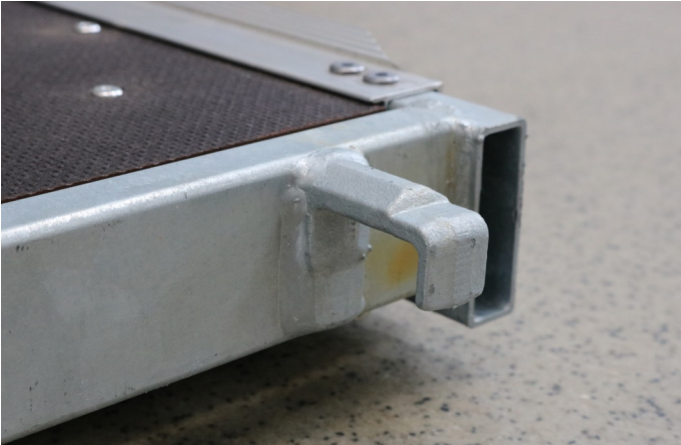





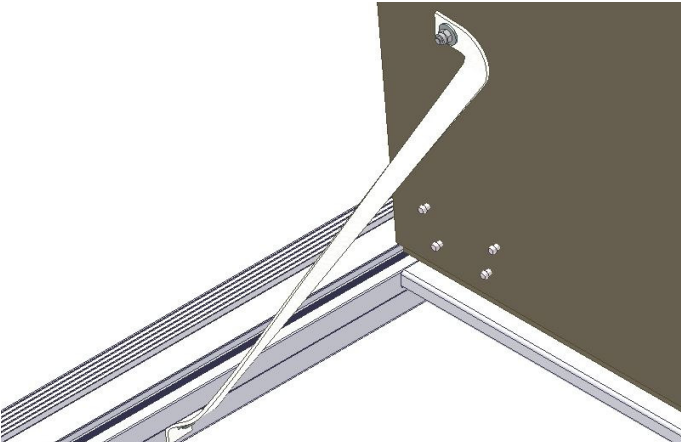

Feljáró	Leírás	Instrukció	Fizetési kondíció	Típus
	<p>33.10.08 Járófelület</p> <ul style="list-style-type: none"> ■ Kopott ■ Vagy használhatatlan erőszakos használat miatt 	 	 	 
	<p>33.10.09 Zár megsérült</p>			

PERI Bérleti kritérium

PERI UP Alaptermékek



Feljáró	Leírás	Instrukció	Fizetési kondíció	Típus
	33.10.62 Rögzítő / tartó fülek			
	<ul style="list-style-type: none"> ■ Repedés nélkül elhajlott ≤ 5 mm 			
	<ul style="list-style-type: none"> ■ Vagy hajlás > 5 mm 			
	<ul style="list-style-type: none"> ■ Vagy repedés 			
	33.10.11 Kötél			
	<ul style="list-style-type: none"> ■ Levágták 			
	<ul style="list-style-type: none"> ■ Vagy hiányzik 			

PERI Bérleti kritérium

PERI UP Alaptermékek



Vízszintes heveder UH, UH Plusz és UH-2 Plusz

Sorsz.

Leírás

Cikkszám

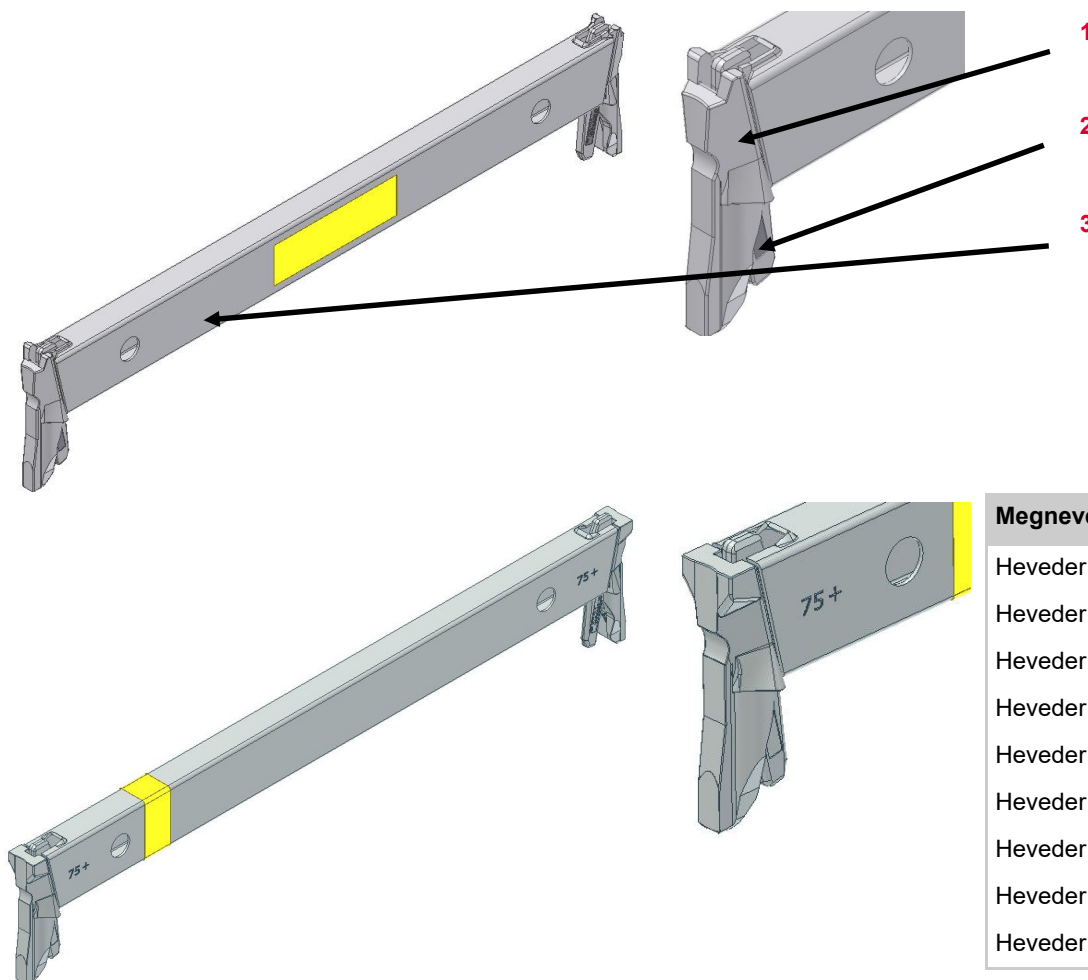

1

1

Ék-ház

2

2

Ék

3

3

Zártszelvény









Megnevezés	Cikkszám
Heveder UH 25 Plusz	114613
Heveder UH 37,5 Plusz	125840
Heveder UH 50 Plusz	114595
Heveder UH 67 Plusz	129982
Heveder UH 72 Plusz	114124
Heveder UH 75 Plusz	114629
Heveder UH 100 Plusz	114632
Heveder UH 104 Plusz	114635
Heveder UH 125 Plusz	114638
Heveder UH 150 Plusz	114641
Heveder UH 175 Plusz	117032
Heveder UH 200 Plusz	114645
Heveder UH 225 Plusz	116356
Heveder UH 250 Plusz	114648
Heveder UH 300 Plusz	114651
Heveder UH 400 Plusz	114654

Megnevezés	Cikkszám
Heveder UH 72	100440
Heveder UH 104	100192
Heveder UH 150	100021
Heveder UH 200	100023
Heveder UH 250	100025
Heveder UH 300	100027
Heveder UH 400	100029
Heveder UH 75	100017
Heveder UH 100	101159

PERI Bérleti kritérium

PERI UP Alaptermékek



UH, UH Plusz és UH-2 Plusz	Leírás	Instrukció	Fizetési kondíció	Típus
	<p>33.10.11 Horpadás a profilon</p> <ul style="list-style-type: none">■ Az élek nem érintettek	 		
	<p>33.10.12 Ékház sérült, kiszakadt / ék hiányzik</p>			

PERI Bérleti kritérium

PERI UP Alaptermékek



UH, UH Plusz és UH-2 Plusz	Leírás	Instrukció	Fizetési kondíció	Típus
----------------------------	--------	------------	-------------------	-------



33.10.14 Horpadás a profilon

- Ha az éleket érinti



33.10.15 Horpadás a heveder végén









- Ha az éleket nem érinti
És nincs repedés
És az ék funkciója megmaradt
- Ha az éleket érinti
- Ha repedés van
- Ha az ék nem működik



PERI Bérleti kritérium

PERI UP Alaptermékek



UH, UH Plusz és UH-2 Plusz	Leírás	Instrukció	Fizetési kondíció	Típus
	33.10.16 Furat deformálódik	<ul style="list-style-type: none"> Ha az eredeti geometria megmarad  		
	<ul style="list-style-type: none"> Ha megváltozik 			
	<ul style="list-style-type: none"> Ha repedés keletkezik 			
	33.10.17 Profil függőleges irányban hajlott			

PERI Bérleti kritérium

PERI UP Alaptermékek



UH, UH Plusz és UH-2 Plusz	Leírás	Instrukció	Fizetési kondíció	Típus
----------------------------	--------	------------	-------------------	-------



33.10.18 Profil vízszintes irányban hajlott

- Nem sérültek az élek és \leq megengedett elhajlás (l/300)



Megnevezés	Engedett hajlás
Heveder UH 25	3 mm
Heveder UH 50	3 mm
Heveder UH 75	3 mm
Heveder UH 100	3 mm
Heveder UH 125	4 mm
Heveder UH 150	5 mm
Heveder UH 200	7 mm
Heveder UH 250	8 mm
Heveder UH 300	10 mm

- Vagy $>$ a megengedett hajlásnál



PERI Bérleti kritérium

PERI UP Alaptermékek



Alaprúd UVB | Rúdelem UVR, UVR-2 | Zárórúd UVH, UVH-2

Sorsz.

Leírás

Cikkszám

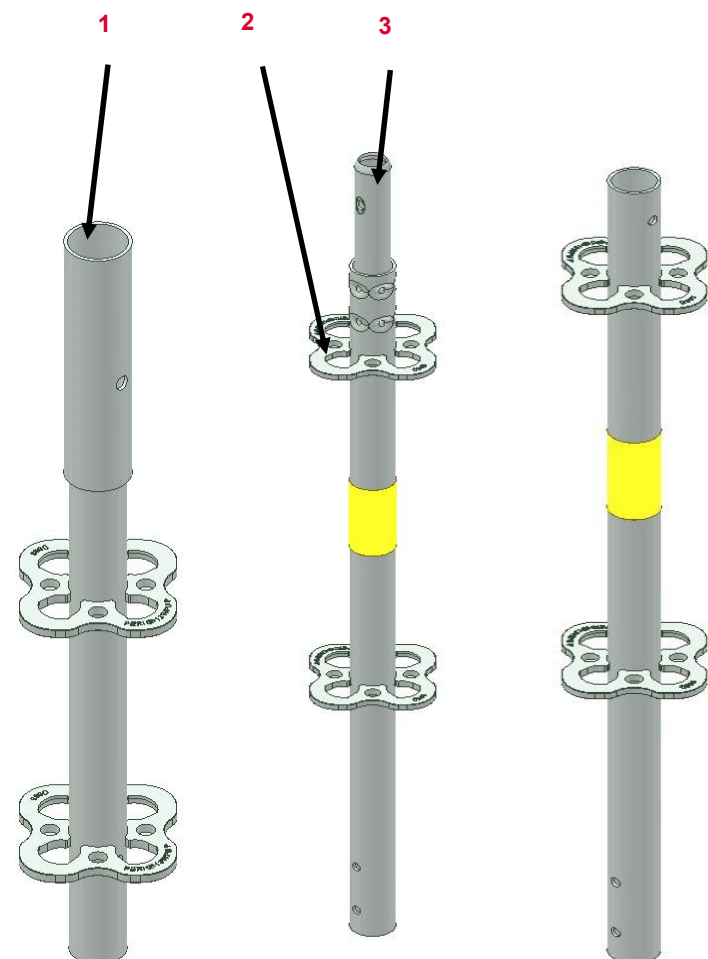

1 Csomópont

2 Rozetta

3 Csap

Megnevezés















Cikkszám

Alaprúd UVB 24	100014
Alaprúd UVB 49	117194
Rúdelem UVR 50	102859
Rúdelem UVR 100	101306
Rúdelem UVR 150	102860
Rúdelem UVR 200	100009
Rúdelem UVR 300	100012
Rúdelem UVR 400	100013
Zárórúd UVH 50	101309
Zárórúd UVH 100	100000
Zárórúd UVH 125	117195
Zárórúd UVH 150	100003
Zárórúd UVH 200	100005
Zárórúd UVH 250	100007

PERI Bérleti kritérium

PERI UP Alaptermékek



Alapelemek	Leírás	Instrukció	Fizetési kondíció	Típus
	33.10.19 Rozetta elgörbült			
	<ul style="list-style-type: none"> ■ ≤ 20 mm 			
	<ul style="list-style-type: none"> ■ Vagy > 20 mm 			
	<ul style="list-style-type: none"> ■ Vagy repedés a rozettán 			
	33.10.20 Erős szennyeződés			

PERI Bérleti kritérium

PERI UP Alaptermékek



Alapelemek	Leírás	Instrukció	Fizetési kondíció	Típus
------------	--------	------------	-------------------	-------



33.10.21 UVR, UVR-2 elgörbült

- > Megengedett hajlás (L/500)



Megnevezés	Megengedett hajlás
UVR 50	5 mm
UVR 100	5 mm
UVR 150	5 mm
UVR 200	5 mm
UVR 300	6 mm
UVR 400	8 mm



33.10.22 Csomópont vagy csap elgörbült

- Összeszerelése nem lehetséges



- Vagy repedés az anyagban



PERI Bérleti kritérium

PERI UP Alaptermékek



Csavaros talp UJB | Csavaros talp UJS csuklós | Csavaros toldó UJK

Sorsz.

Leírás

Cikkszám

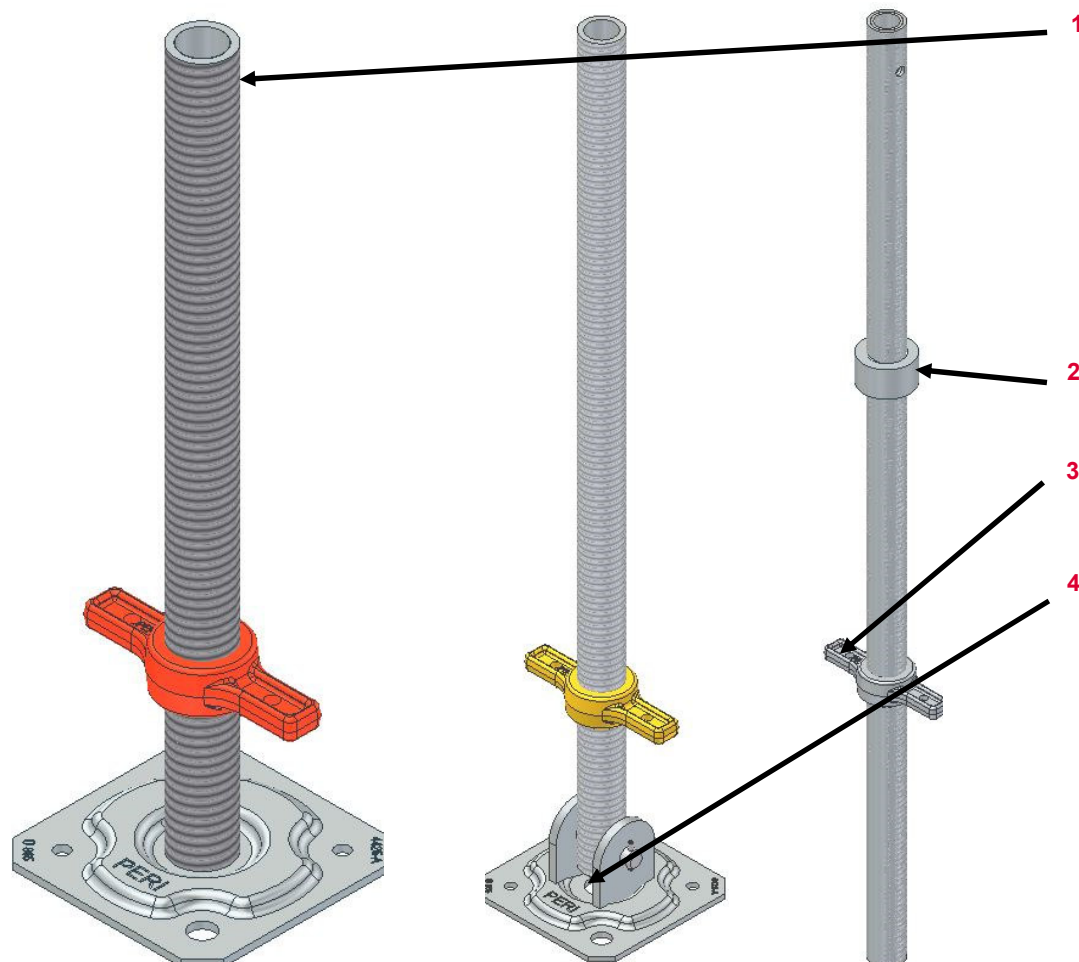

1

Orsó

2

Hegesztett anya

3

Szintező anya 38

710071

4

Alaplemez

Gültig für

Artikelnummer

Csavaros talp UJB 38-36/17

116762

Csavaros talp UJB 38-36/30

100411

Csavaros talp UJB 38-36/55

100242

Csavaros talp UJS 38-80 /50 csuklós

100159











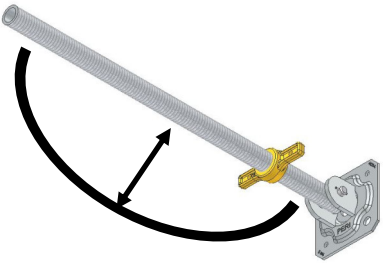



Csavaros toldó UJK 38-110/41

111072

PERI Bérleti kritérium

PERI UP Alaptermékek

















Csavaros talp	Leírás	Instrukció	Fizetési kondíció	Típus
	33.10.23 Orsó elhajlott			
	33.10.24 Szintező anya eltört			
	33.10.25 Alaplemez elhajlott <ul style="list-style-type: none"> ■ Ha lehetséges ■ Ha nem lehetséges ■ Vagy repedt 	 	 088244 	 

PERI Bérleti kritérium

PERI UP Alaptermékek



Talplemez UJP (100244)	Leírás	Instrukció	Fizetési kondíció	Típus
	33.10.26 Alaplemez elhajlott			
	<ul style="list-style-type: none"> ■ Ha lehetséges 			
	<ul style="list-style-type: none"> ■ Ha nem lehetséges 			
	<ul style="list-style-type: none"> ■ Vagy ha repedt 			
	33.10.27 Elhajlott cső			

PERI Bérleti kritérium

PERI UP Alaptermékek



UP Biztosító kötés UJS talp (100863)	Leírás	Instrukció	Fizetési kondíció	Típus
--------------------------------------	--------	------------	-------------------	-------



33.10.28 Nem zár, elhajlott

- Funkcióját nem tölti be

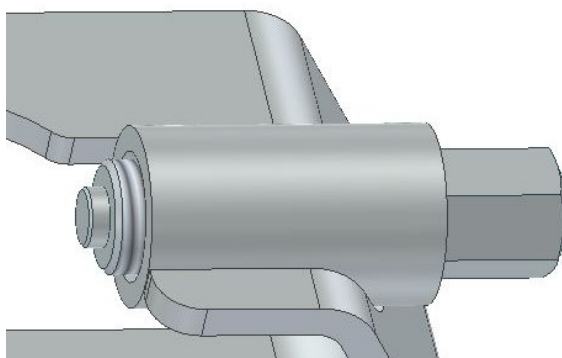

33.10.29 A csavar sérülése

- Elhasználódás miatt ha lehetséges



- Ha nem lehetséges













- Erőszakos behatás miatt

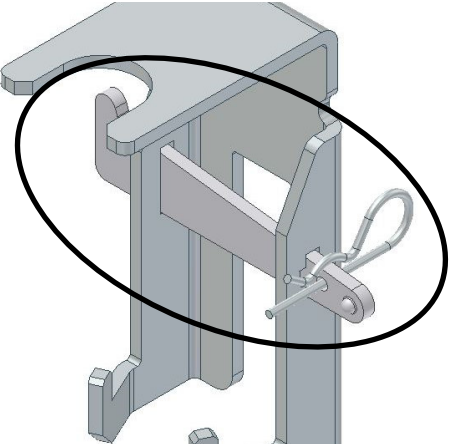

PERI Bérleti kritérium

PERI UP Alaptermékek



UP Biztosító kötés UJH Fej (109563)	Leírás	Instrukció	Fizetési kondíció	Típus
	<p>33.10.30 Nem zár, elhajlott</p> <ul style="list-style-type: none">■ Ha lehetséges■ Ha nem lehetséges	<p>■ Ha lehetséges: </p> <p>■ Ha nem lehetséges: </p>	<p>■ Ha lehetséges: </p> <p>■ Ha nem lehetséges: </p>	<p>■ Ha lehetséges: </p> <p>■ Ha nem lehetséges: </p>
	<p>33.10.31 Az ék hiányzik / sérült</p>	<p></p>	<p></p>	<p></p>

PERI Bérleti kritérium

PERI UP Alaptermékek



UP Átlós merevítő UBL















Sorsz.	Leírás	Cikkszám
1	Behelyező csap	
2	Cső	
3	Hasított ék	710910
4	Ék FL	710123

PERI Bérleti kritérium

PERI UP Alaptermékek

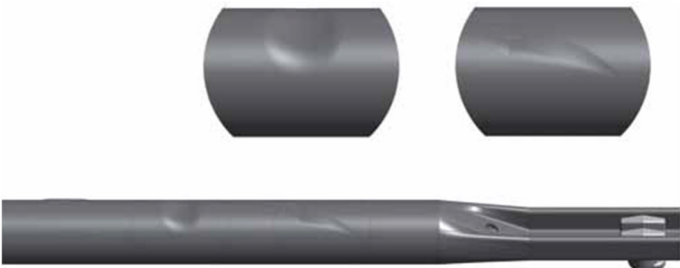

Átlós merevítő UBL	Leírás	Instrukció	Fizetési kondíció	Típus
	33.10.32 Biztosító ék <ul style="list-style-type: none"> ■ Hiányzik 	 710910 (Hasított ék) 710123 (Ék)		
	<ul style="list-style-type: none"> ■ Vagy sérült 	 710910 (Hasított ék) 710123 (Ék)		
	33.10.33 Elem elhajlása <ul style="list-style-type: none"> ■ > 5 mm (l/500) 			
	33.10.34 Horpadás a profilon <ul style="list-style-type: none"> ■ $\varnothing > 3$ cm 			

PERI Bérleti kritérium

PERI UP Alaptermékek



Csomópont mervítő UBK

Sorsz.	Leírás	Cikkszám
--------	--------	----------

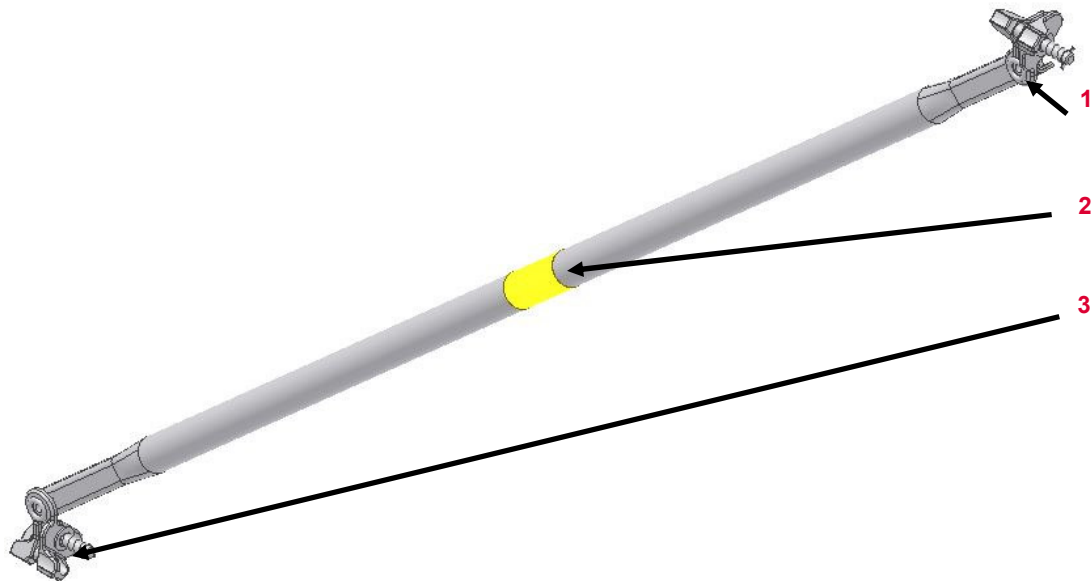

- | | |
|---|----------------------|
| 1 | Csatlakozás UBK jobb |
| 2 | Cső UBK |
| 3 | Csatlakozás UBK bal |

PERI Bérleti kritérium

PERI UP Alaptermékek











Megnevezés	Cikkszám
Csomópont merevítő UBK 72/100	106969
Csomópont merevítő UBK 104/100	100977
Csomópont merevítő UBK 125/100	115354
Csomópont merevítő UBK 150/100	100981
Csomópont merevítő UBK 200/100	100985
Csomópont merevítő UBK 250/100	100989
Csomópont merevítő UBK 300/100	100993
Csomópont merevítő UBK 150/150	100973
Csomópont merevítő UBK 200/150	106630
Csomópont merevítő UBK 250/150	106624

Megnevezés	Cikkszám
Csomópont merevítő UBK 72/200	100969
Csomópont merevítő UBK 75/200	124170
Csomópont merevítő UBK 100/200	112926
Csomópont merevítő UBK 104/200	100840
Csomópont merevítő UBK 125/200	112765
Csomópont merevítő UBK 150/200	100572
Csomópont merevítő UBK 200/200	100573
Csomópont merevítő UBK 250/200	100574
Csomópont merevítő UBK 300/200	100575

PERI Bérleti kritérium

PERI UP Alaptermékek



Csomópont merevítő	Leírás	Instrukció	Fizetési kondíció	Típus
	33.10.35 Perem sérült			
	33.10.36 Hiányzó csomópont kapcsoló			

PERI Bérleti kritérium

PERI UP Alaptermékek



Vízszintes Merevítő UBH UBH Flex	Sorsz.	Leírás	Cikkszám
------------------------------------	--------	--------	----------

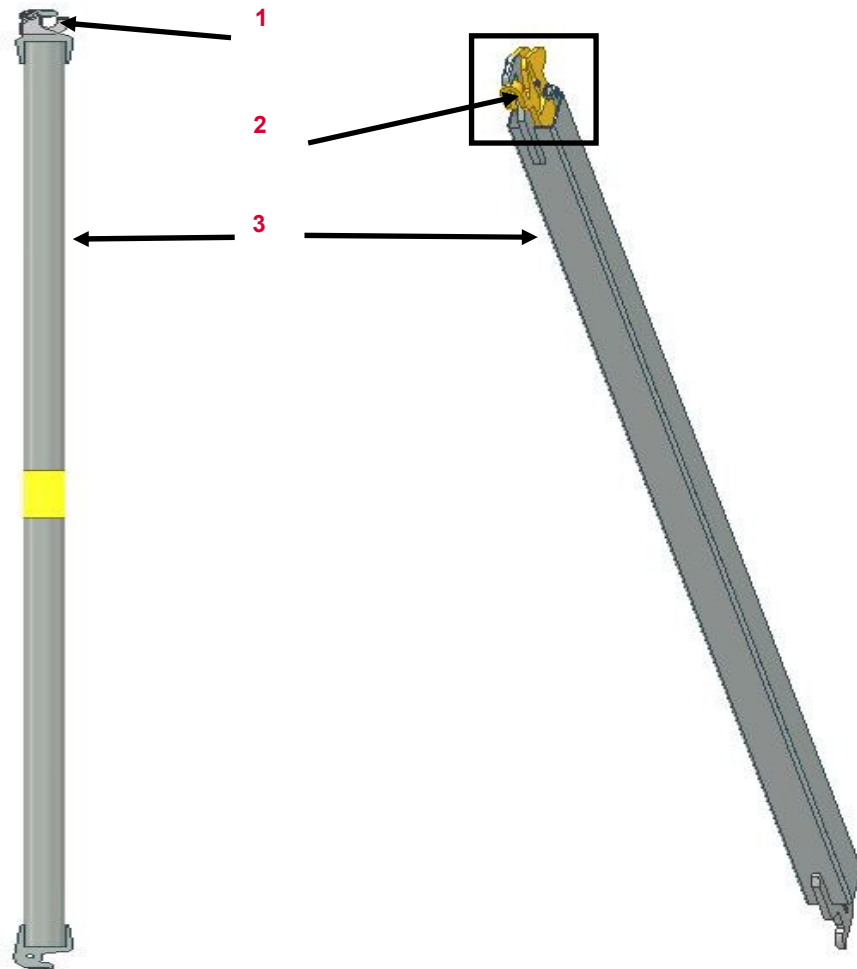

1	Retesz UBH	
2	Csúszka UBH	114874
3	Cső / Zártszelvény (Flex)	
4	Csavar M 8x35	114862
5	Hasított ék	780807
6	Önzáró anya	114861

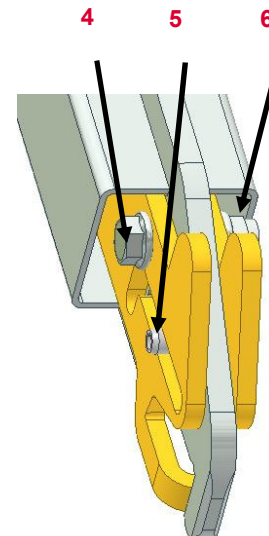

PERI Bérleti kritérium

PERI UP Alaptermékek



Megnevezés	Cikkszám
Vízszintes mervítő UBH 150/150	100042
Vízszintes mervítő UBH 200/150	107815
Vízszintes mervítő UBH 250/150	106931
Vízszintes mervítő UBH 300/150	100051
Vízszintes mervítő UBH 200/200	100047
Vízszintes mervítő UBH 250/200	104356
Vízszintes mervítő UBH 300/200	123483
Vízszintes mervítő UBH 250/250	100049
Vízszintes mervítő UBH 300/300	100053
Vízszintes mervítő UBH FLEX 250/75	114896
Vízszintes mervítő UBH FLEX 300/75	114900
Vízszintes mervítő UBH FLEX 100/100	114818
Vízszintes mervítő UBH FLEX 150/100	114821
Vízszintes mervítő UBH FLEX 200/100	114820

Megnevezés	Cikkszám
Vízszintes mervítő UBH FLEX 250/100	114819
Vízszintes mervítő UBH FLEX 300/100	114892
Vízszintes mervítő UBH FLEX 125/125	114904
Vízszintes mervítő UBH FLEX 150/125	114908
Vízszintes mervítő UBH FLEX 250/125	114996
Vízszintes mervítő UBH FLEX 150/150	114912
Vízszintes mervítő UBH FLEX 200/200	114916
Vízszintes mervítő UBH FLEX 250/200	114920
Vízszintes mervítő UBH FLEX 300/200	114924
Vízszintes mervítő UBH FLEX 250/250	114928
Vízszintes mervítő UBH FLEX 300/250	114932
Vízszintes mervítő UBH FLEX 300/300	114936
Vízszintes mervítő UBH FLEX 200/150	124097
Vízszintes mervítő UBH FLEX 250/150	124101
Vízszintes mervítő UBH FLEX 300/150	124105

PERI Bérleti kritérium

PERI UP Alaptermékek



Vízszintes merevítő UBH, UBH Flex	Leírás	Instrukció	Fizetési kondíció	Típus
-----------------------------------	--------	------------	-------------------	-------

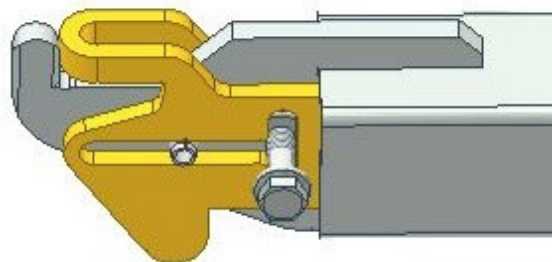

33.10.37 Retesz | Csúszka nem működik

- UBH
- Vagy UBH Flex

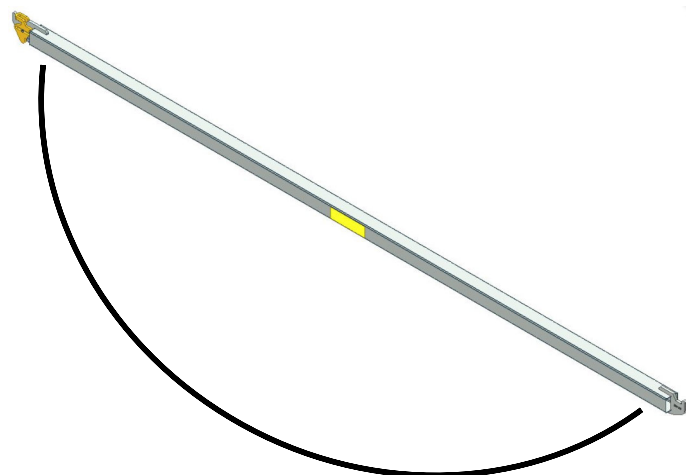

33.10.38 A Cső / Zártszelvény elhajlott













- > l/500

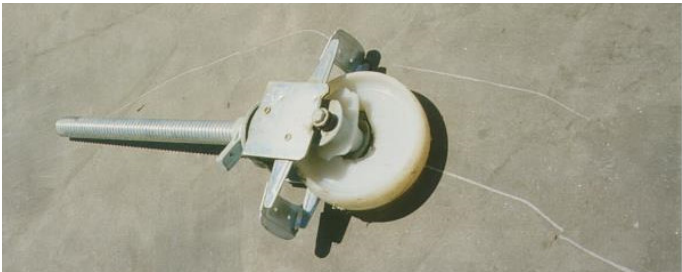

PERI Bérleti kritérium

PERI UP Alaptermékek











UP Áthelyező kerék UEW (101858 101860)	Leírás	Instrukció	Fizetési kondíció	Típus
	33.10.39 Levágott Elhajlott orsó			
	33.10.40 Orsó letört			
	33.10.41 Kerék eltört Túlterhelés helytelen használat mi- att			

PERI Bérleti kritérium

PERI UP Alaptermékek



Kerék Orsóval UEW (101858 101860)	Leírás	Instrukció	Fizetési kondíció	Típus
	33.10.42 Szintező anya eltört			
	33.10.43 Fék nem működik			

PERI Bérleti kritérium

PERI UP Alaptermékek



Rácsos tartó acél ULS | Alu ULA















Sorsz.	Leírás	Cikkszám
1	Fő elem	
2	Függőleges merevítő	
3	Átlós merevítő	

Megnevezés	Cikkszám
Rácsos tartó acél ULS 50/425	100330
Rácsos tartó acél ULS 50/525	100336
Rácsos tartó acél ULS 50/625	100339
Rácsos tartó acél ULS 70/525	100185
Rácsos tartó acél ULS 70/625	100183
Rácsos tartó acél ULS 70/825	100852
Rácsos tartó Alu ULA 50/425 HD	101656
Rácsos tartó Alu ULA 50/525 HD	101657
Rácsos tartó Alu ULA 50/625 HD	101658
Rácsos tartó Alu ULA 50/825 HD	101659

PERI Bérleti kritérium

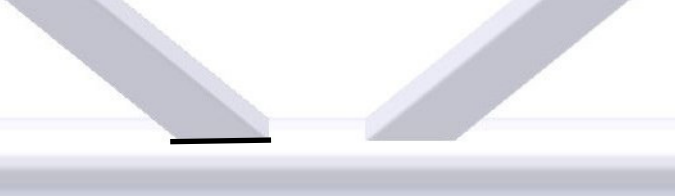
PERI UP Alaptermékek



Rácsos tartó	Leírás	Instrukció	Fizetési kondíció	Típus						
	33.10.44 Rácsos tartó elhajlott ■ > Megengedett hajlás (L/500)									
	<table border="1"> <thead> <tr> <th>Hossz</th> <th>Megeng. hajlás</th> </tr> </thead> <tbody> <tr> <td>425</td> <td>9 mm</td> </tr> <tr> <td>525</td> <td>11 mm</td> </tr> <tr> <td>625</td> <td>13 mm</td> </tr> <tr> <td>825</td> <td>17mm</td> </tr> </tbody> </table>				Hossz	Megeng. hajlás	425	9 mm	525	11 mm
Hossz	Megeng. hajlás									
425	9 mm									
525	11 mm									
625	13 mm									
825	17mm									
	33.10.45 Átlós / függőleges merevítő elhajlott									
	33.10.46 Repedés									

PERI Bérleti kritérium

PERI UP Alaptermékek



Létra Flex UEL (126318)	Leírás	Instrukció	Fizetési kondíció	Típus
	33.10.47 Akasztó fül elhajlott / törött			
	<ul style="list-style-type: none"> ■ Az létra károsodása nélkül 			
	<ul style="list-style-type: none"> ■ Vagy károsodással 			
	33.10.48 Létrafok elhajlott			
	33.10.49 Repedés a hegesztésben			
	<ul style="list-style-type: none"> ■ Létra vagy fok sérülése nélkül 			
	<ul style="list-style-type: none"> ■ Vagy azok sérülésével 			

PERI Bérleti kritérium

PERI UP Alaptermékek











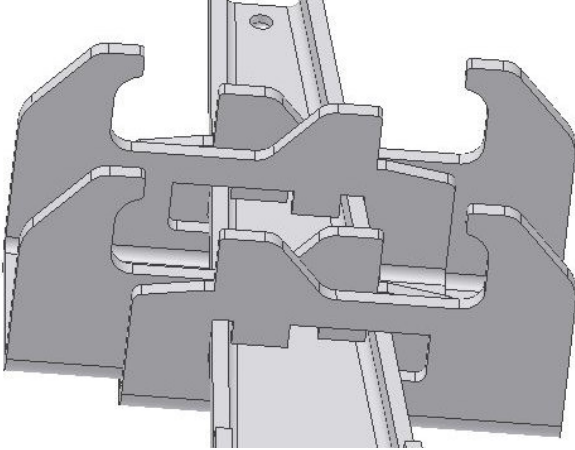

Csúsztható Elem (100529)	Leírás	Instrukció	Fizetési kondíció	Típus
	33.10.50 Csap hajlott / horpadt			
	■ Nem illeszthető			
	■ Vagy $d > 3 \text{ mm}$			
	33.10.51 Cső hajlott horpadt			
	■ $\varnothing > 3 \text{ cm}$			
	■ vagy mélység $> 3 \text{ mm}$			
	33.10.52 Lemez hajlott			
	■ Ha lehetséges			
	■ Vagy ha nem lehetséges			

PERI Bérleti kritérium

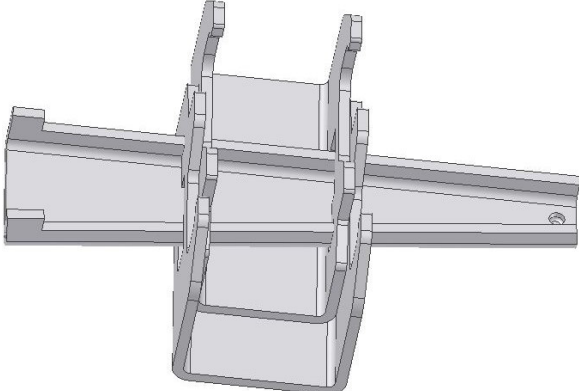
PERI UP Alaptermékek



Tábla kapcsoló UDC (111011)	Leírás	Instrukció	Fizetési kondíció	Típus
	33.10.53 Karmok elhajlottak			
	<ul style="list-style-type: none">■ Ha lehetséges■ Vagy ha nem lehetséges	 	 	 
	33.10.54 Ék hajlott /nem mozgatható			

PERI Bérleti kritérium

PERI UP Alaptermékek



Kikötő rúd UWT



Sorsz.	Leírás	Cikkszám
--------	--------	----------

1	Horog
---	-------

2	Rúd
---	-----

Megnevezés	Cikkszám
------------	----------

Kikötő rúd UWT 45	100088
-------------------	--------

Kikötő rúd UWT 110	100091
--------------------	--------

Kikötő rúd UWT 140	100093
--------------------	--------

Kikötő rúd UWT 170	102951
--------------------	--------

Kikötő rúd UWT 220	102954
--------------------	--------

Kikötő rúd UWT 270	102957
--------------------	--------

Kikötő rúd UWT	Leírás	Instrukció	Fizetési kondíció	Típus
----------------	--------	------------	-------------------	-------



33.10.55 Horog rozsdás

- Hegesztés sértetlen



Rozsda eltávolítása után, zinc spray használata



33.10.56 kikötő rúd elhajlott

- > megengedett hajlás (l/500)











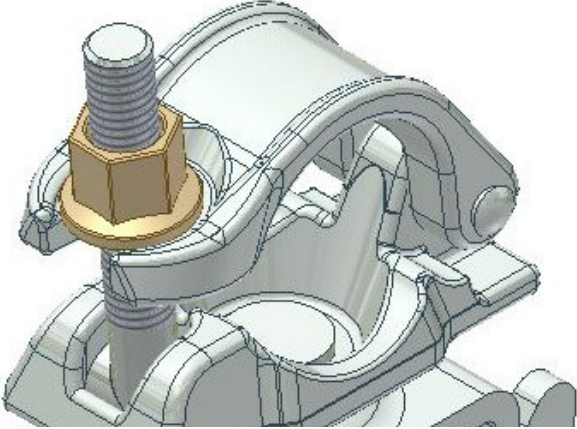

Megnevezés	Megengedett
UWT 45	3,0 mm
UWT 110	3,0 mm
UWT 140	3,0 mm
UWT 170	4,0 mm
UWT 220	4,0 mm
UWT 270	5,0 mm

PERI Bérleti kritérium

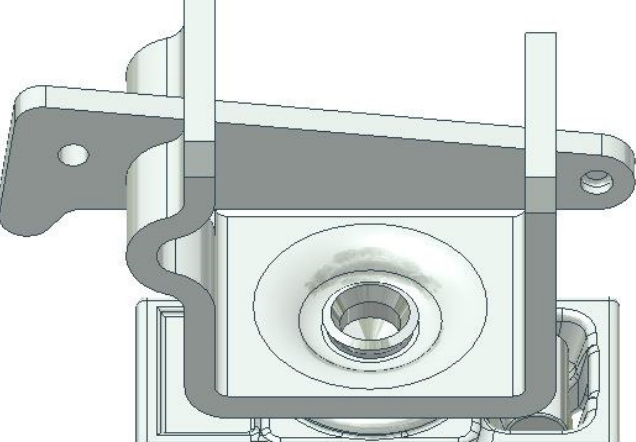
PERI UP Alaptermékek



Csatlakozó UH (105824)	Leírás	Instrukció	Fizetési kondíció	Típus
	<p>33.10.57 Kalapácsfejű csavar Anya</p> <ul style="list-style-type: none"> ■ Hiányzik ■ Használhatatlan 	<ul style="list-style-type: none">  710702 (Csavar) 710340 (Anya)  710702 (Csavar) 710340 (Anya) 	<ul style="list-style-type: none">   	<ul style="list-style-type: none">  
	<p>33.10.58 Ék hiányzik</p>			

PERI Bérleti kritérium

PERI UP Alaptermékek



Rosetta csatlakozó UEV 90 180 (126453 116306)	Leírás	Instrukció	Fizetési kondíció	Típus
---	--------	------------	-------------------	-------

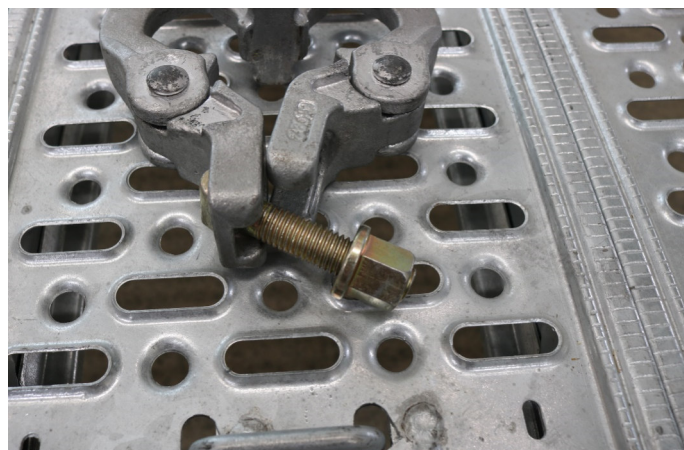

33.10.59 Kalapácsfejű csavar / Anya

- Hiányzik



117475 (Csavar)
118091 (Anya)



- Vagy használhatatlan



117475 (Csavar)
118091 (Anya)



33.10.60 Tengely kapcsoló nem működik

- Erőltetés miatt (Elhajlás)













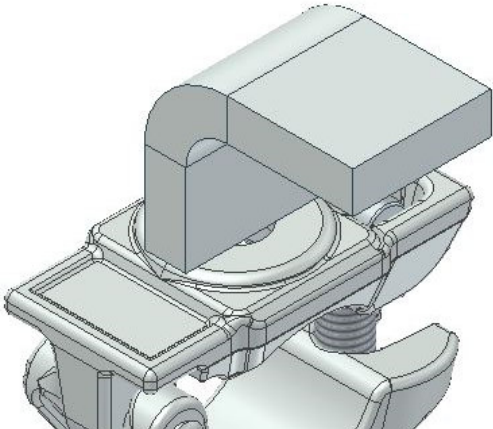





- Vagy kopás okozta károsodás (Rozsda)

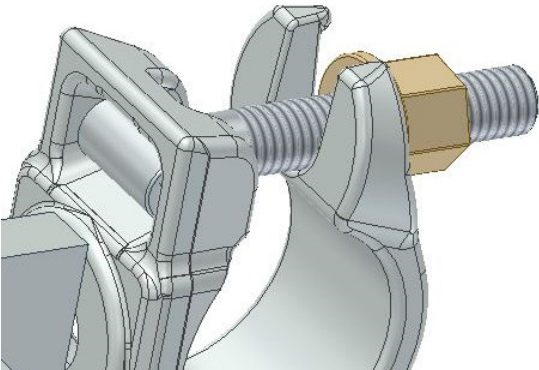

PERI Bérleti kritérium

PERI UP Alaptermékek



Perem csatlakozó UEC (113726)	Leírás	Instrukció	Fizetési kondíció	Típus
	33.10.61 Konzol elhajlott			
	■ Ha lehetséges			
	■ Vagy ha nem lehetséges			
	■ Vagy repedés hegesztésen, anyagban			
	33.10.62 Kalapácsfejű csavar Anya			
	■ Hiányzik	 710702 (Csavar) 710340 (Anya)		
	■ Vagy használhatatlan	 710702 (Csavar) 710340 (Anya)		

PERI Bérleti kritérium

PERI UP Alaptermékek



Létrás feljáró UAW –L

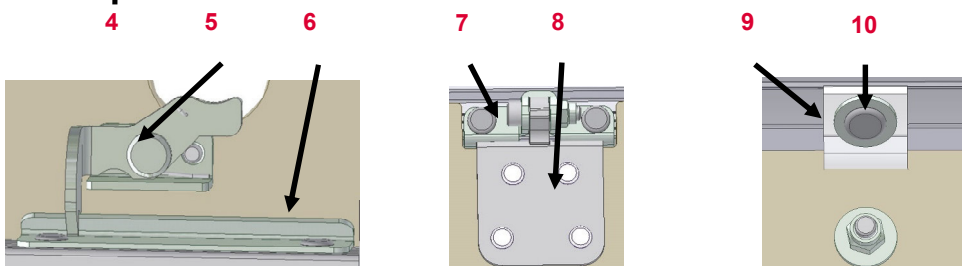
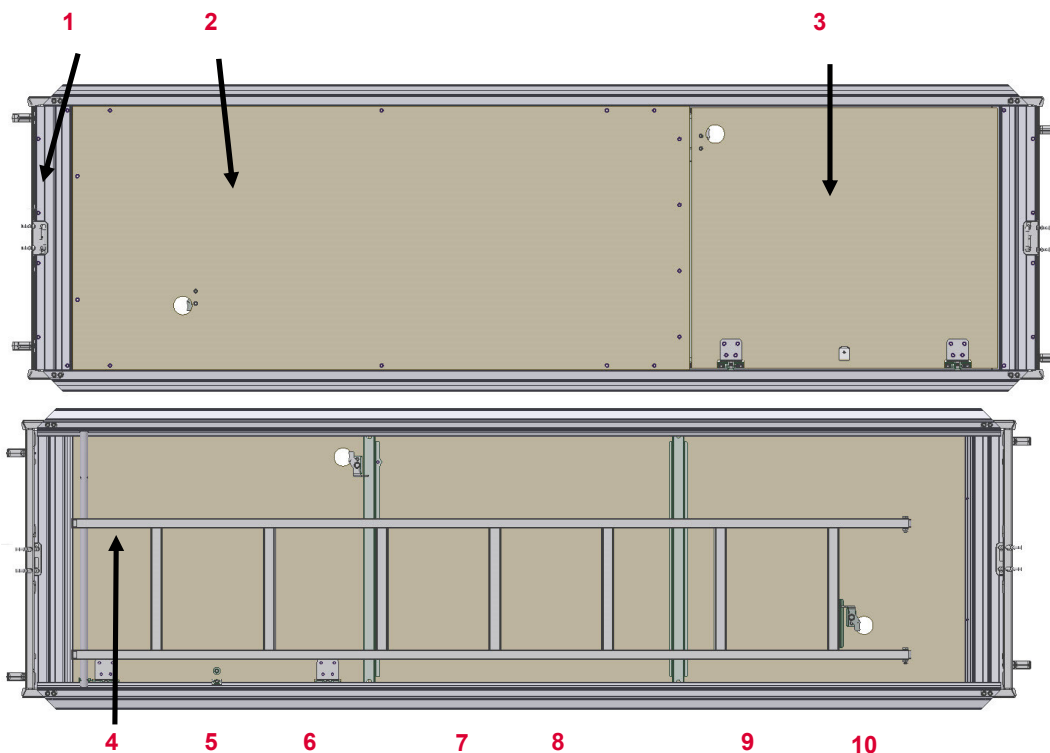

Sorsz.	Leírás	Cikkszám
1	Rögzítő / tartó fül	132971
2	Járófelület	
3	Ajtó	132977
4	Létra	133158
5	Retesz	132598
6	Retesz Profil	132588
7	Zsanér tartó	132586
8	Zsanér	132606
9	Szíj	132587
10	Szegecs	722318

Megnevezés	Cikkszám
Létrás feljáró UAW 75x150-L	134046
Létrás feljáró UAW 75x200-L	132996
Létrás feljáró UAW 75x250-L	130334
Létrás feljáró UAW 75x300-L	133309

PERI Bérleti kritérium

PERI UP Alaptermékek



Létrás feljáró UAA-L

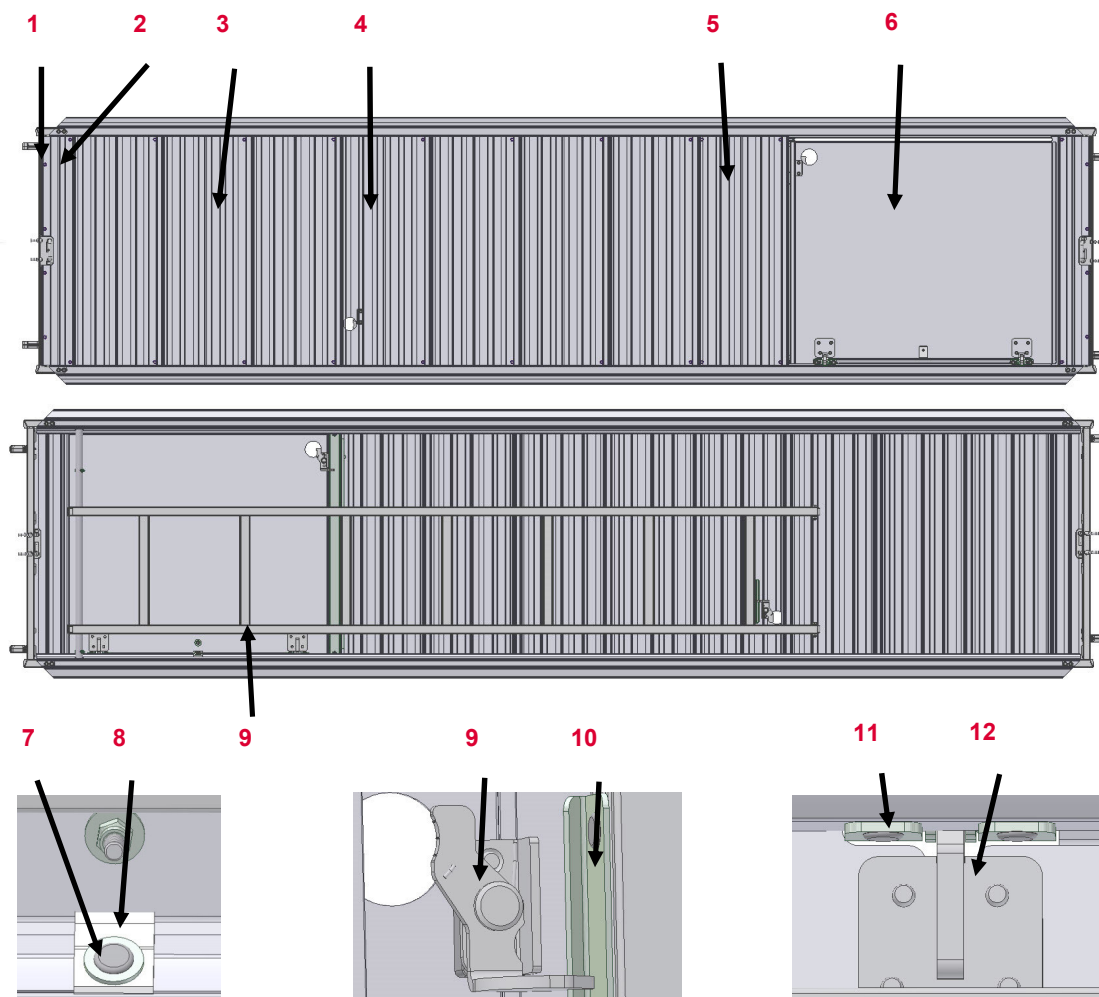

















Sorsz.	Leírás	Cikkszám
1	Rögzítő / tartó fül	132971
2	Indító Profil	132973
3	Profil	132986
4	Létra Profil	132985
5	Vég Profil	133469
6	Ajtó Alu	132984
7	Szegecs	722318
8	Szij EPDM	132587
9	Retes	132598
10	Retesz Profil	132588
11	Zsanér tartó	132586

Megnevezés	Cikkszám
Létrás feljáró UAA 75x150-L	132993
Létrás feljáró UAA 75x200-L	132990
Létrás feljáró UAA 75x250-L	133314
Létrás feljáró UAA 75x300-L	133315

PERI Bérleti kritérium

PERI UP Alaptermékek













Létrás feljáró UAA UAW	Leírás	Instrukció	Fizetési kondíció	Típus
	33.10.61 Pánt <ul style="list-style-type: none"> ■ Elhasználódott 			
	<ul style="list-style-type: none"> ■ Vagy szakadt / hiányzik 			
	33.10.62 Rögzítő / tartó fülek <ul style="list-style-type: none"> ■ Repedés nélkül elhajlott ≤ 5 mm 			
	<ul style="list-style-type: none"> ■ Vagy hajlás > 5 mm 			
	<ul style="list-style-type: none"> ■ Vagy repedés 			

PERI Bérleti kritérium

PERI UP Alaptermékek

















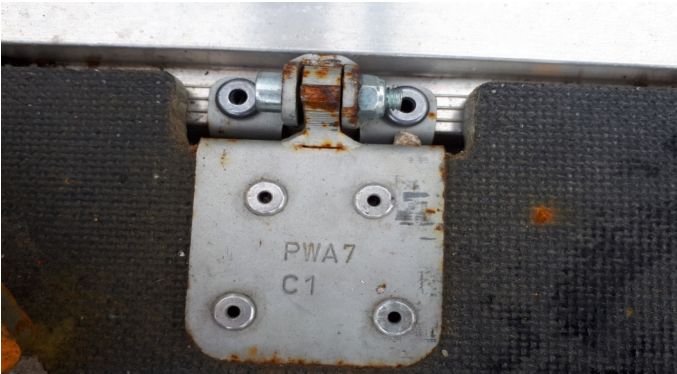

Létrás feljáró UAA UAW	Leírás	Instrukció	Fizetési kondíció	Típus
	33.10.63 Retesz sérült			
	33.10.64 Ajtó			
	<ul style="list-style-type: none">■ Elhasználódott			
	<ul style="list-style-type: none">■ Vagy erőltetés miatt megsérült			

PERI Bérleti kritérium

PERI UP Alaptermékek













Létrás feljáró UAA UAW	Leírás	Instrukció	Fizetési kondíció	Típus
	33.10.65 Létra <ul style="list-style-type: none"> ■ Hiányzik ■ Vagy repedés a hegesztésen 	 	 	 
	33.10.48 Létrafok elhajlott			
	33.10.66 Zsanér Zsanér tartó <ul style="list-style-type: none"> ■ Hiányzik ■ Vagy erőltetés miatt megsérült (funkcióját nem tölti be) 	 	 	 

PERI Bérleti kritérium

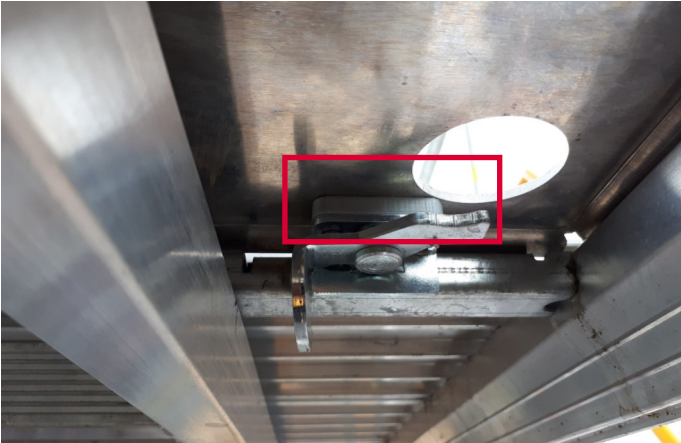
PERI UP Alaptermékek





Létrás feljáró UAA	Leírás	Instrukció	Fizetési kondíció	Típus
	33.10.67 Aluminium Profil			
	■ Repedés a profilon			
	■ Vagy lyuk > Ø 5 mm			
	33.10.68 Retesz hiányzik	 133014 (Retesz)		

PERI Bérleti kritérium

PERI UP Alaptermékek









Létrás feljáró UAW	Leírás	Instrukció	Fizetési kondíció	Típus
	33.10.69 Rétegelt lemez			
	<ul style="list-style-type: none"> ■ Elhasználódott ■ Vagy erő hatására megsérült (Repedés vagy furat > Ø 5 mm) 	 	 	 

Icon	Significance	Icon	Significance	Icon	Significance
	Nem Ok– Selejtezendő		Ügyfélnek számlázandó		Optikai kár
	OK– marad a bérleti parkban		Nincs számlázás		Funkcionális sérülés
	Selejt anyag– biztonsági okokból az anyagot tilos kiadni		Anyagot levágni		Funkcionális sérülés— anyag kiadása nem engedélyezett
	Javítás az előírások szerint		Anyagot megjelölni		Statikai sérülés— anyag kiadása nem engedélyezett
	Hideg egyengetés– utána a varratokat és a környékét ellenőrizni kell		Sérült anyag cseréje		
	Javítás gazdaságosság függvényében		Hiányzó anyag pótlása		
	Megtisztítani az anyagot				

PERI Bérleti kritérium

PERI UP Alaptermékek



Schaden Xyyyyy	Leírás	Instrukció	Fizetési kondíció	Típus
				
				

PERI Bérleti kritérium

PERI UP Alaptermékek



GT 24 Schalungsträger	Sorsz.	Leírás	Cikkszám
	1	1	
	2	2	
	3	3	
	4	4	

PERI Bérleti kritérium

PERI UP Alaptermékek



Schaden Xyyyyy	Leírás	Instrukció	Fizetési kondíció	Típus

PERI Bérleti kritérium

PERI UP Alaptermékek



Schaden	Leírás	Instrukció	Fizetési kondíció	Típus
---------	--------	------------	-------------------	-------

PERI Bérleti kritérium

PERI UP Alaptermékek



Sorsz..	Leírás	Cikkszám
1	Gurtholz	keine
2	Strebe	keine
3	Stahlkappe verzinkt	726041
4	Stahl-Rohniet	726040

Schaden	Leírás	Instrukció	Fizetési kondíció	Típus
---------	--------	------------	-------------------	-------

PERI Bérleti kritérium

PERI UP Alaptermékek



Kapcsolat

**PERI Kft,
Zsaluzatok, állványzatok,
mérnöki szolgáltatás**

H-1181 Budapest
Zádor u. 9.
Tel.: +36-1-296-09-60

Inhalt	Seite

Inhalt	Seite

PERI Bérleti kritérium

PERI UP Alaptermékek



Kapcsolat

**PERI Kft,
Zsaluzatok, állványzatok,
mérnöki szolgáltatás**

H-1181 Budapest
Zádor u. 9.
Tel.: +36-1-296-09-60

Vorgenommene Änderungen	Datum Kürzel, Wer	Seite
Neuerstellung Layout	07/2015 rf	

Vorgenommene Änderungen	Datum Kürzel, Wer	Seite
Neuerstellung Layout	07/2015 rf	

PERI Bérleti kritérium

PERI UP Alaptermékek



Kapcsolat

**PERI Kft,
Zsaluzatok, állványzatok,
mérnöki szolgáltatás**

H-1181 Budapest
Zádor u. 9.
Tel.: +36-1-296-09-60

Inhalt	Seite

Inhalt	Seite

Ab hier folgen die Seiten für die Schäden auf Basis der Gestaltungsvorlage für eine Zeile.

Die Abstände der Zeilen sind dadurch verschiebbar.

PERI Bérleti kritérium

PERI UP Alaptermékek



Schaden Xyyyyy	Leírás	Instrukció	Fizetési kondíció	Típus

PERI Bérleti kritérium

PERI UP Alaptermékek



Schaden Xyyyyy	Leírás	Instrukció	Fizetési kondíció	Típus

Ab hier folgen die Seiten für die Schäden auf Basis unterschiedlicher Gestaltungsvorlagen:

1 Zeile, 2 Zeilen, 3 Zeilen und 4 Zeilen

Die Abstände der Zeilen sind jeweils nicht verschiebbar.

PERI Bérleti kritérium

PERI UP Alaptermékek



Schaden Xyyyyy	Leírás	Instrukció	Fizetési kondíció	Típus
------------------	--------	------------	-------------------	-------



PERI Bérleti kritérium

PERI UP Alaptermékek



Schaden	Leírás	Instrukció	Fizetési kondíció	Típus
				
				

PERI Bérleti kritérium

PERI UP Alaptermékek



Schaden	Leírás	Instrukció	Fizetési kondíció	Típus

PERI Bérleti kritérium

PERI UP Alaptermékek



Schaden	Leírás	Instrukció	Fizetési kondíció	Típus

