

PERI Bérleti kritériumok

SRS körpillér zsaluzat

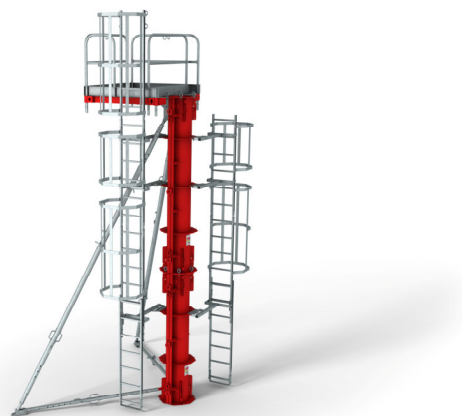

Kapcsolat

PERI kft,
zsaluzatok, állványzatok,
mérnöki szolgáltatás

H-1181 Budapest
Zádor u. 9.
Tel.: +36-1-296-09-60
www.peri.hu

Tartalom	Oldal
Körpillér zsaluelem	2
Körzsalu csatlakozó elem TRIO-hoz	9
Körzsalu betonozópodesz	10
Létra 180/6	13
Létracsatlakozó SRS	14
Létrakorlát	15
Magyarázat	16

Változás	Dátum ü	Oldal
Új verzió	10/2015 O.L.	

PERI Bérleti kritériumok

SRS körpillér zsaluzat



Körpillér zsaluelem

Sorszám	Megnevezés	Cikkszám
---------	------------	----------

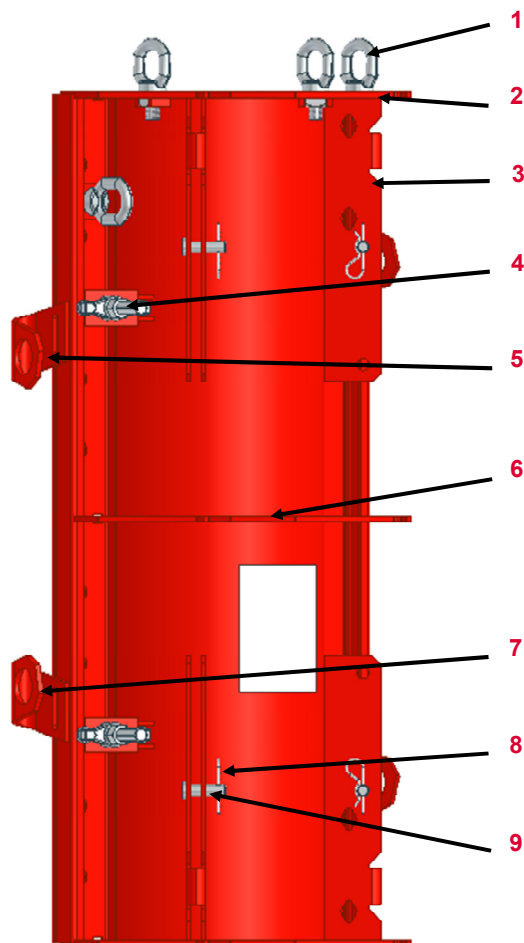

1	Szemcsavar M20x40	710130
2	Fedőlap	
3	Faltámasz csatlakozó	
4	T fejű átkötő menetes szár	710038
5	Körzsalu akasztófül jobb	725275
6	Híd	
7	Körzsalu akasztófül bal	725278
8	Sasszeg 4/1	018060
9	Csap D=16x42	027170

PERI Bérleti kritériumok

SRS körpillér zsaluzat

















Cikk	Cikkszám
Körzsalu Ø 25 cm, h= 0,30 m	045010
Körzsalu Ø 25 cm, h= 1,20 m	045011
Körzsalu Ø 25 cm, h= 2,40 m	045012
Körzsalu Ø 25 cm, h= 3,00 m	045013
Körzsalu Ø 30 cm, h= 0,30 m	045020
Körzsalu Ø 30 cm, h= 1,20 m	045021
Körzsalu Ø 30 cm, h= 2,40 m	045022
Körzsalu Ø 30 cm, h= 3,00 m	045023
Körzsalu Ø 35 cm, h= 0,30 m	045030
Körzsalu Ø 35 cm, h= 1,20 m	045031
Körzsalu Ø 35 cm, h= 2,40 m	045032
Körzsalu Ø 35 cm, h= 3,00 m	045033

Cikk	Cikkszám
Körzsalu Ø 40 cm, h= 0,30 m	045040
Körzsalu Ø 40 cm, h= 1,20 m	045041
Körzsalu Ø 40 cm, h= 2,40 m	045042
Körzsalu Ø 40 cm, h= 3,00 m	045043
Körzsalu Ø 45 cm, h= 0,30 m	045050
Körzsalu Ø 45 cm, h= 1,20 m	045051
Körzsalu Ø 45 cm, h= 2,40 m	045052
Körzsalu Ø 45 cm, h= 3,00 m	045053
Körzsalu Ø 50 cm, h= 0,30 m	045060
Körzsalu Ø 50 cm, h= 1,20 m	045061
Körzsalu Ø 50 cm, h= 2,40 m	045062
Körzsalu Ø 50 cm, h= 3,00 m	045063

PERI Bérleti kritériumok

SRS körpillér zsaluzat











Körpillér zsaluelem	Leírás	Instrukció	Fizetési Kondíciók	Típus
	23.01 Akasztófül deformálódott, vágott			
	<ul style="list-style-type: none"> ■ Deformáció \leq 6 mm 		 088244	
	<ul style="list-style-type: none"> ■ Vagy > 6 mm 		 088592	
	<ul style="list-style-type: none"> ■ Vagy vágott 		 088592	
	23.02 Távtartó elem törött, vágott			

PERI Bérleti kritériumok

SRS körpillér zsaluzat

















Körpillér zsaluelem	Leírás	Instrukció	Fizetési Kondíciók	Típus
	23.03 Porszórt felület enyhén sérült	 Sérülést sorjátlanítani, utána formaleválasztóval kezelni		
	23.04 Porszórt felület erősen sérült	 Homokfúvással tisztítani és új porszórással ellátni		

PERI Bérleti kritériumok

SRS körpillér zsaluzat



Körpillér zsaluelem	Leírás	Instrukció	Fizetési Kondíciók	Típus
	23.06 Zsaluzó felület túlzottan hajlott <ul style="list-style-type: none"> ■ Anyagvesztés nélkül 		 088244	
	<ul style="list-style-type: none"> ■ Vagy anyagvesztéssel 			
	23.07 Fedőlemez vagy híd deformálódott <ul style="list-style-type: none"> ■ > 4 mm 		 088244	
	23.08 Horpadás a zsaluzó felületen <ul style="list-style-type: none"> ■ > 3 mm 		 088244	

PERI Bérleti kritériumok

SRS körpillér zsaluzat











Körpillér zsaluelem	Leírás	Instrukció	Fizetési Kondíciók	Típus
	23.08 Lyukak a zsaluzó felületen <ul style="list-style-type: none"> ■ $\leq \varnothing 10 \text{ mm}$ (max. 2 lyuk/m) 			
	<ul style="list-style-type: none"> ■ Vagy $> 10 \text{ mm}$ 			
	<ul style="list-style-type: none"> ■ Vagy $> 3 \text{ lyuk./m}$ 			
	23.09 Elem deformálódott <ul style="list-style-type: none"> ■ $> 5 \text{ mm}$ 			

PERI Bérleti kritériumok

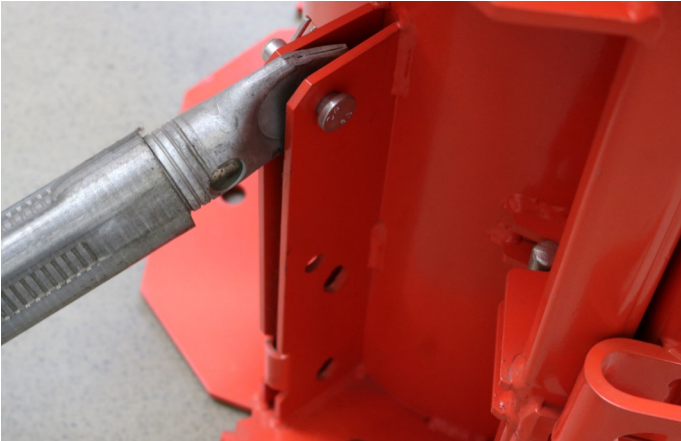
SRS körpillér zsaluzat









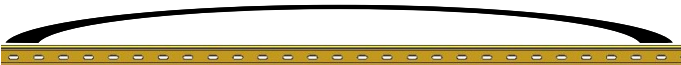

Körpillér zsaluelem	Leírás	Instrukció	Fizetési Kondíciók	Típus
	23.10 Rakatóló elem deformálódott		 088244	
	23.11 Faltámasz kapcsoló deformálódott		 088244	

PERI Bérleti kritériumok

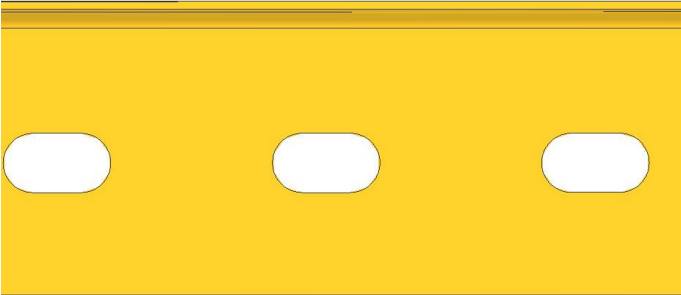
SRS körpillér zsaluzat



Körzsalu csatlakozó elem TRIO-hoz (045200)	Leírás	Instrukció	Fizetési Kondíciók	Típus
	<p>23.12 Csatlakozó elem deformálódott</p> <p>■ > 5 mm</p>			
	<p>23.13 Lyukak kitágultak</p>			

PERI Bérleti kritériumok

SRS körpillér zsaluzat



Körzsalu betonozópodesz 25– 70, (045210)

Sorszám Megnevezés Cikkszám

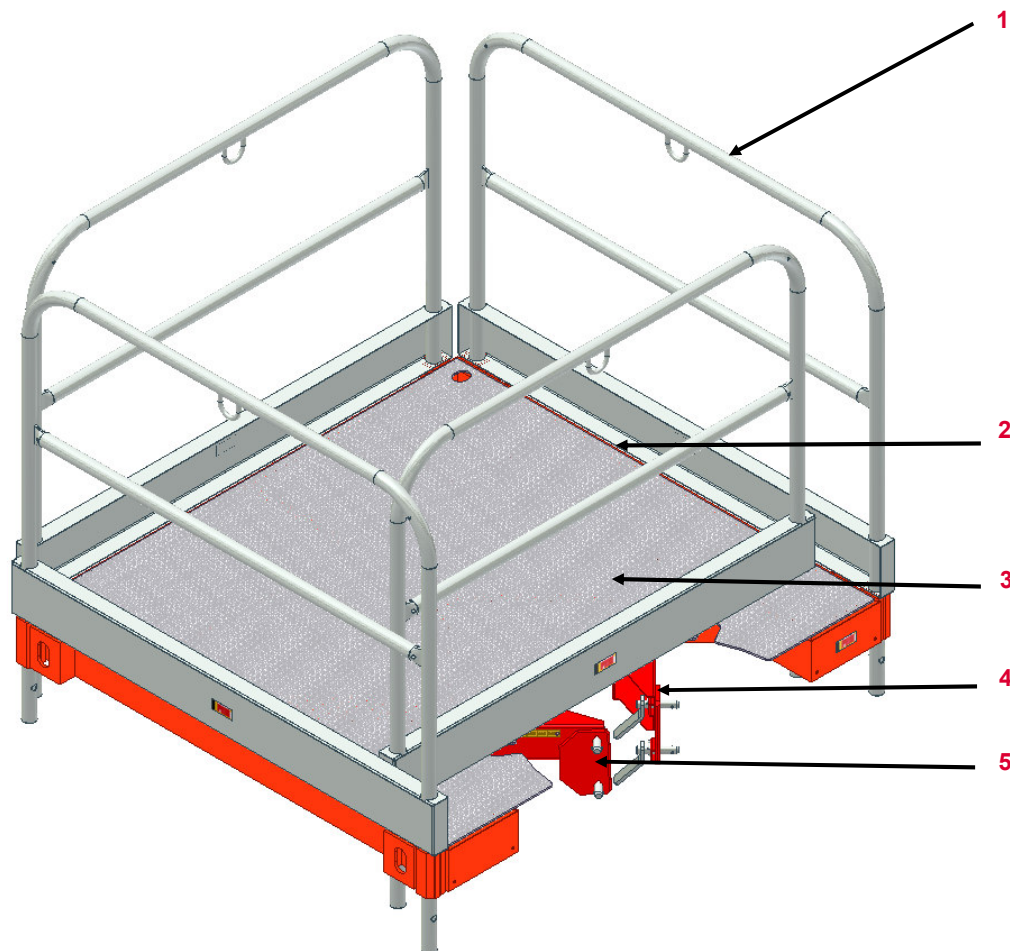



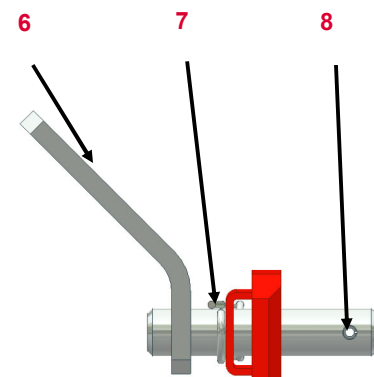







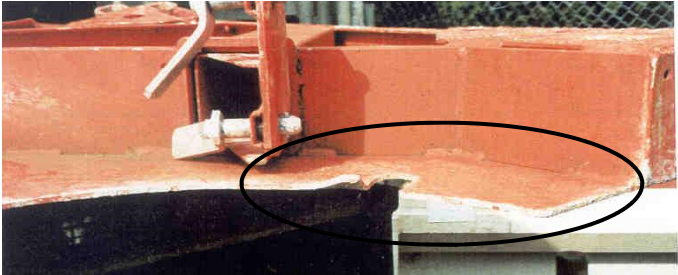

1	Védőkoriát 134	037430
2	Körzsalu podesz 25– 70	045211
3	Járófelület lemez	
4	Teleszkóp cső bal	785229
5	Teleszkóp cső jobb	785227
6	Csap	785232
7	Reteszelő rugó	115507
8	Feszítőhüvely	710417

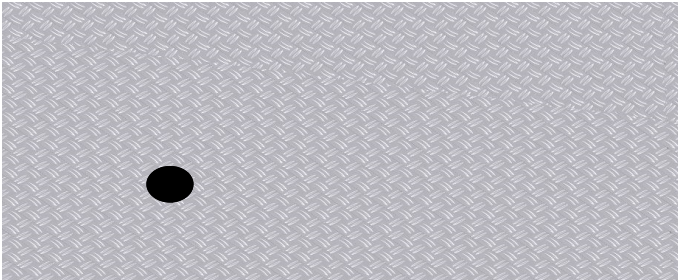

PERI Bérleti kritériumok

SRS körpillér zsaluzat

















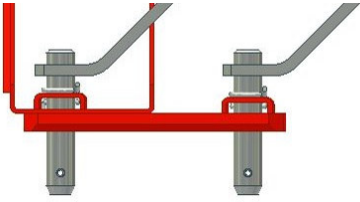

Körzsalu betonozópodesz	Leírás	Instrukció	Fizetési Kondíciók	Típus
	23.14 Járófelület lemez deformálódott		 088244	
	23.15 Lyukak a járófelület lemezén			
	<ul style="list-style-type: none"> ■ ≤ 10 mm ■ Vagy > 10 mm 			
	23.16 Védőkorlát rögzítések deformálódtak vagy kitágultak			

PERI Bérleti kritériumok

SRS körpillér zsaluzat













Teleszkóp cső	Leírás	Instrukció	Fizetési Kondíciók	Típus
	23.17 Bekötő deformálódott	 Teleszkóp cső bal(785229) Teleszkóp cső jobb (785227)	 088595	
	23.18 Lyukak kitágultak	 Teleszkóp cső bal (785229) Teleszkóp cső jobb (785227)	 088595	
	23.19 Csapok használhatatlanok	 Csap(785232) Feszítőhüvely(710417) Reteszelő rugó(115507)	 088789	
	23.20 Mérőszalag olvashatatlan, hiányzik	 Mérőszalag jobb (780318) Mérőszalag bal(780317) Popszegecs(780304)		

PERI Bérleti kritériumok

SRS körpillér zsaluzat



Létra 180/6 (051410)	Leírás	Instrukció	Fizetési Kondíciók	Típus
	23.21 Létrafok deformálódott ■ > 3 mm			
	23.22 Hegesztés repedt ■ Az alapanyag deformációja nélkül			
	■ Vagy az alapanyag deformációjával			

PERI Bérleti kritériumok

SRS Körpillér zsaluzat



Létracsatlakozó SRS (103374)

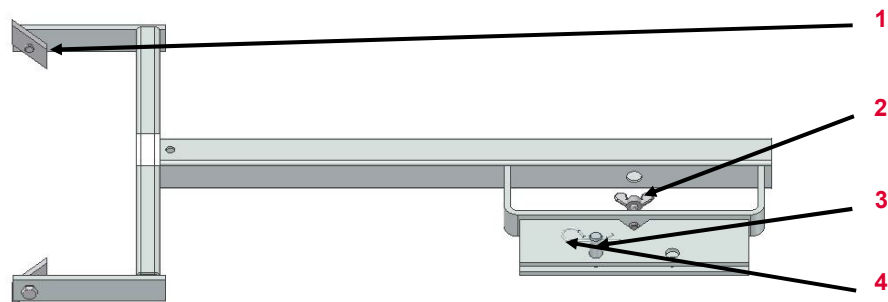

Sorszám	Megnevezés	Cikkszám
1	Szorítólemez	701763
2	Csavar	106955
3	Csap d16x42	027171
4	Sasszeg 4/1	018060

Sérülés

Leírás

Instrukció

Fizetési Kondíciók

Típus



23.23 Szorítólemez selejt, elveszett



Szorítólemez (701763)
Csavar M12x25 (710266)



088295

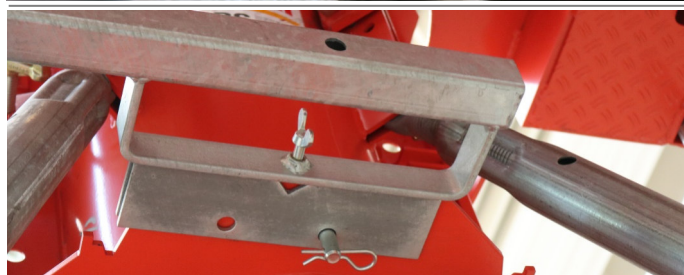

23.24 Konzol lemezek
deformálódott, használhatatlan



PERI Bérleti kritériumok

SRS körpillér zsaluzat



Létrakorlát (104132; 051450)	Leírás	Instrukció	Fizetési Kondíciók	Típus
------------------------------	--------	------------	--------------------	-------



23.25 Deformálódott

■ > 5 mm



23.26 Szorítólemez selejt, elveszett



Szorítólemez (701763)
Csavar M12x25 (710266)



















088295



PERI Bérleti kritériumok

Magyarázat



Ikon	Jelentés	Ikon	Jelentés	Ikon	Jelentés
	Nem OK — kicselezendő		Ügyfélnek leszámházandó		Optikai kár
	OK– marad a bérleti parkban		Nincs számlázás		Funkcionális sérülés
	Selejt anyag – biztonsági okokból az anyagot tilos kiadni		Anyagot levágni		Funkcionális sérülés — anyag kiadása nem engedélyezett
	Javítás az előírások szerint		Anyagot megjelölni		Statikai sérülés — anyag kiadása nem engedélyezett
	Hideg egyengetés — utána a varratokat és a környékét ellenőrzni kell		Sérült anyag cseréje		
	Javítás gazdaságosság függvényében		Hiányzó anyag cseréje		
	Megtisztítani az anyagot				