

# PERI Bérleti kritériumok

## PERI UP homlokzati állványrendszerek



### Kapcsolat

**PERI Kft**  
**Zsaluzatok, állványzatok,**  
**mérnöki szolgáltatás**  
H-1181 Budapest,  
Zádor u. 9  
+36--1-296-0960  
[www.peri.hu](http://www.peri.hu)



Tartalom	Oldal	Változtatások	Dátum   Által	Page
Járótábla UDS	2	Új verzió	05/2021   O.L.	
Járófelület réskitöltő	7			
Keretek	9			
Létrás feljáró UAL	24			
Lábdeszka UPT-3	29			
Végkorlát	31			
Magyarázat	35			

# PERI Bérleti kritériumok

## PERI UP homlokzati állványrendszerek



### Acél járótábla UDS

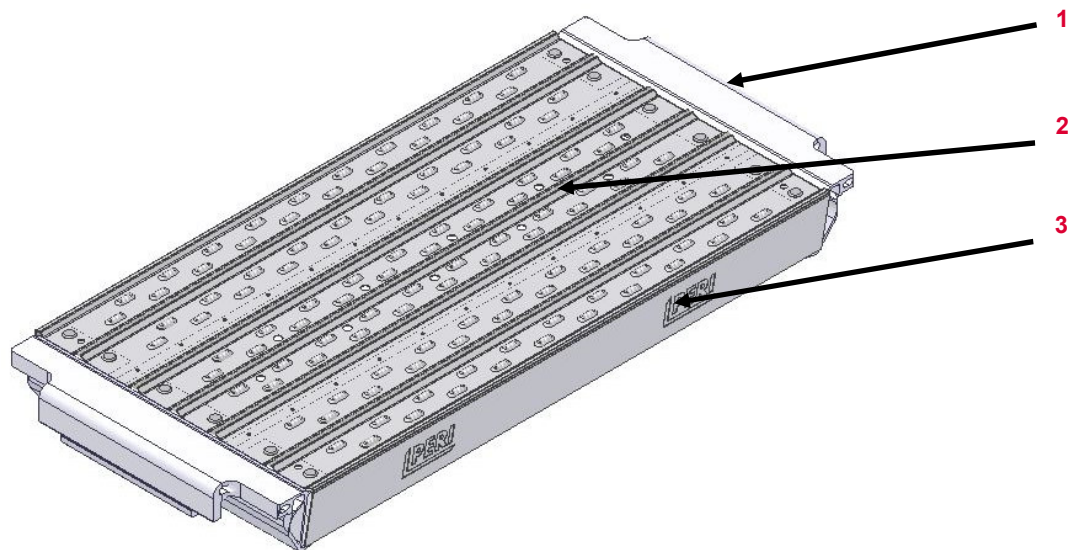

















Sorsz..	leírás	Cikkszám
1	Rögzítő profil	
2	Járófelület	
3	Oldal profil	

Megnevezés	Cikkszám
Járótábla 32x72	100488
Járótábla32x104	100486
Járótábla 32x150	100355
Járótábla 32x200	100373
Járótábla 32x250	100375
Járótábla 32x300	100377
Járótábla 32x400	100820

# PERI Bérleti kritériumok

## PERI UP homlokzati állványrendszerek











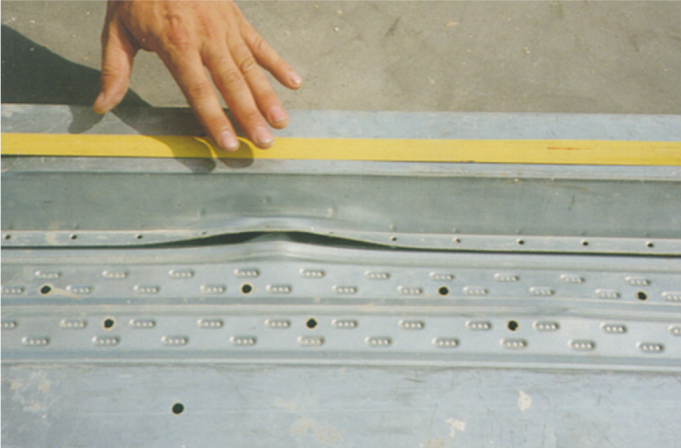

Járótábla UDS	leírás	Instrukció	Fizetési kondíció	Típus
	<p><b>33.20.01 Belső horpadás az oldalprofilon</b></p> <ul style="list-style-type: none"> <li>Nincs deformáció a Tox-csatlakozáson</li> </ul>	 		
	<p><b>33.20.02 Külső horpadás az oldalprofilon</b></p> <ul style="list-style-type: none"> <li>A járótábla könnyen beilleszthető és a profil éle nem sérült</li> </ul>	 		
	<ul style="list-style-type: none"> <li>A járótábla nem beilleszthető vagy a profil éle sérült</li> </ul>			
	<p><b>33.20.03 A járótábla végén horpadt azaz nem beilleszthető</b></p>			

# PERI Bérleti kritériumok

## PERI UP homlokzati állványrendszerek



Járótábla UDS	leírás	Instrukció	Fizetési kondíció	Típus
	<b>33.20.04 Járótábla a felületén horpadt</b>			
	<ul style="list-style-type: none"> <li>■ Ha &gt; 10 mm</li> <li>■ Vagy Tox-Kapcsolat megsérült</li> </ul>	 	 	 
	<b>33.20.05 Járótábla oldala horpadt</b>			
	<ul style="list-style-type: none"> <li>■ &gt; 10 mm</li> </ul>			

# PERI Bérleti kritériumok

## PERI UP homlokzati állványrendszerek













Járótábla UDS	leírás	Instrukció	Fizetési kondíció	Típus
	<b>33.20.06 Lyuk a felületen</b> <ul style="list-style-type: none"> <li>■ <math>\leq 10</math> mm és a borda nem sérült</li> </ul>	 		
	<ul style="list-style-type: none"> <li>■ Vagy <math>&gt; 10</math> mm</li> <li>■ Vagy sérült a borda</li> </ul>			
	<b>33.20.08 Rozsdás felület</b> <ul style="list-style-type: none"> <li>■ Csak felületi rozsdá</li> </ul>			

# PERI Bérleti kritériumok

## PERI UP homlokzati állványrendszerek



Járótábla UDS	leírás	Instrukció	Fizetési kondíció	Típus
	<b>33.20.09 Törött   Hiányzó szegecs</b>			
	<b>33.20.10 Rögzítő / tartó fül</b>			
	<ul style="list-style-type: none"> <li>■ Hajlott</li> <li>■ Vagy törött</li> </ul>	 	 	 

# PERI Bérleti kritériumok

## PERI UP homlokzati állványrendszerek



### Járófelület réskitöltő

Sorsz..

leírás

Cikkszám

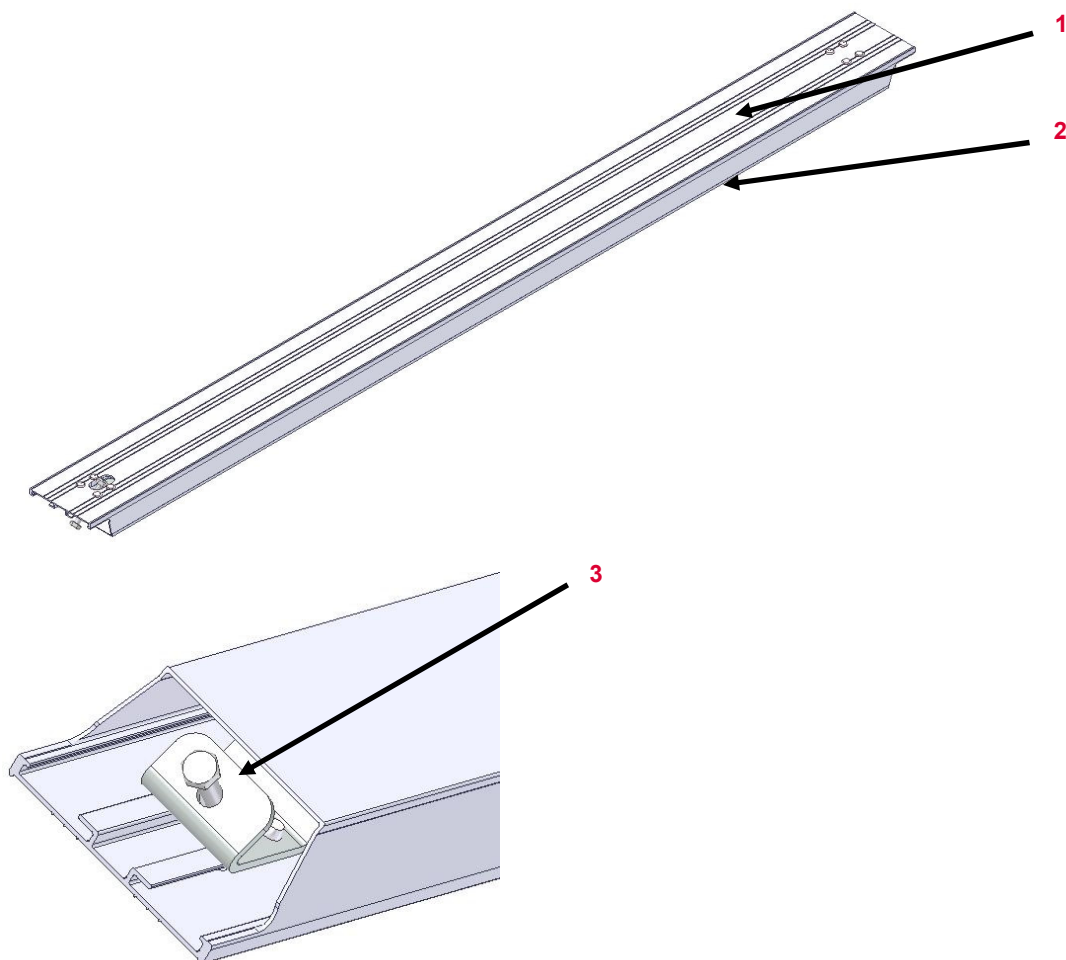

1

Járófelület

2

Alsó oldal

3

Akaszto-rögzítő

#### Cikk megnevezés



#### cikkszám

Járótábla réskitöltő UD 7/150	101360
Járótábla réskitöltő UD 7/200	101372
Járótábla réskitöltő UD 7/250	101373
Járótábla réskitöltő UD 7/300	101375
Járótábla réskitöltő UD 11/150	101394
Járótábla réskitöltő UD 11/200	101378
Járótábla réskitöltő UD 11/250	101379
Járótábla réskitöltő UD 11/300	101381

# PERI Bérleti kritériumok

## PERI UP homlokzati állványrendszerek

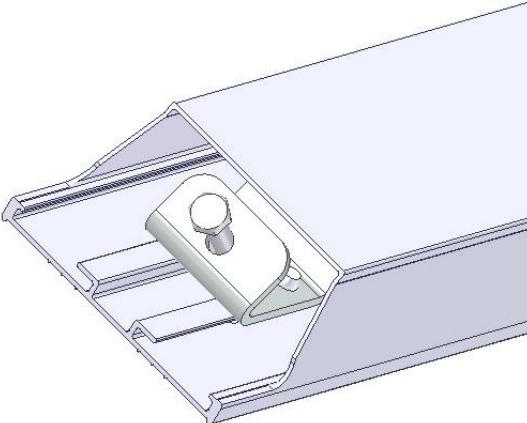

Járótábla réskitöltő	leírás	Instrukció	Fizetési kondíció	Típus
	<p><b>33.20.11 Alsó oldal deformálódott</b></p> <ul style="list-style-type: none"><li>■ Az elem nem behelyezhető</li></ul>			
	<p><b>33.20.12 Akasztó rögzítő deformálódott   Hiányzik</b></p>			



# PERI Bérleti kritériumok

## PERI UP homlokzati állványrendszerek



### Alapkeret UVF | T- keret UVT | L- keret UVL

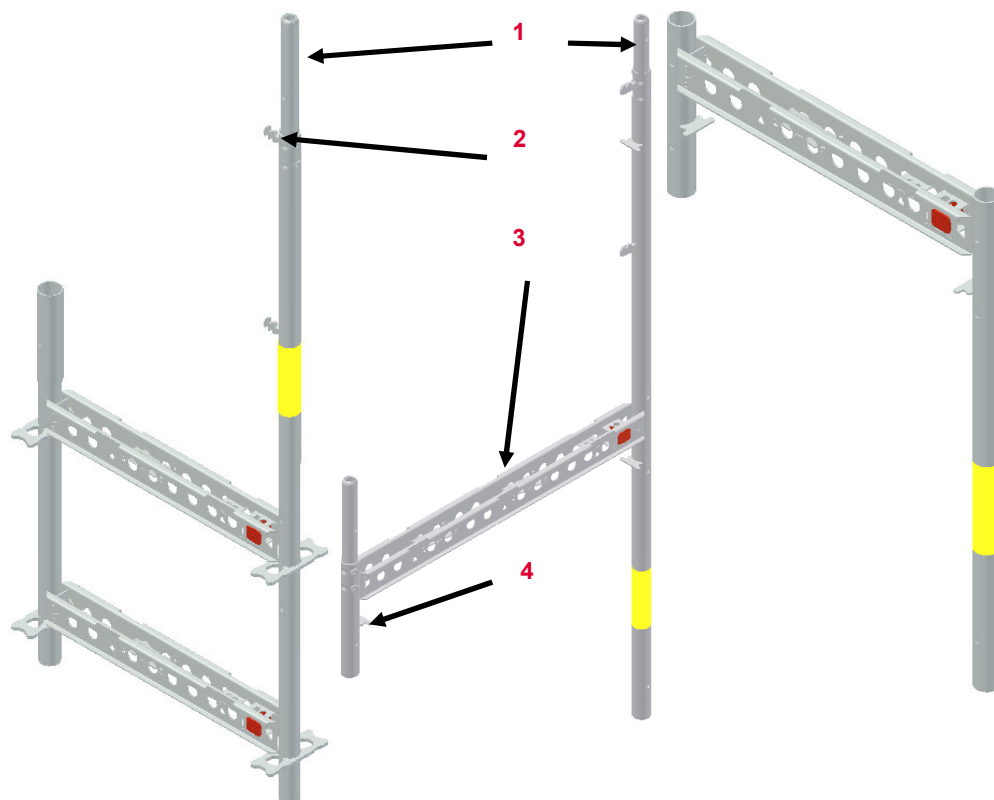















Sorsz..	leírás	Cikkszám
1	Csap	
2	Korlát csatlakozás	
3	Járótábla kapcsoló profil	
4	Ütköző	

Cikk megnevezés	cikkszám
Alap keret UVF 72/124	100200
Alap keret UVF 104/124	100208
Alap keret UVF 72/174	100170
Alap keret UVF 104/174	100172
T- keret UVT 72/200	100212
T- keret UVT 104/200	100216
L- keret UVL 72/100	100217
L- keret UVL 104/100	100219
Átjáró keret UVG 104/240	106965
Átjáró keret UVG 176/240	100322

# PERI Bérleti kritériumok

## PERI UP homlokzati állványrendszerek









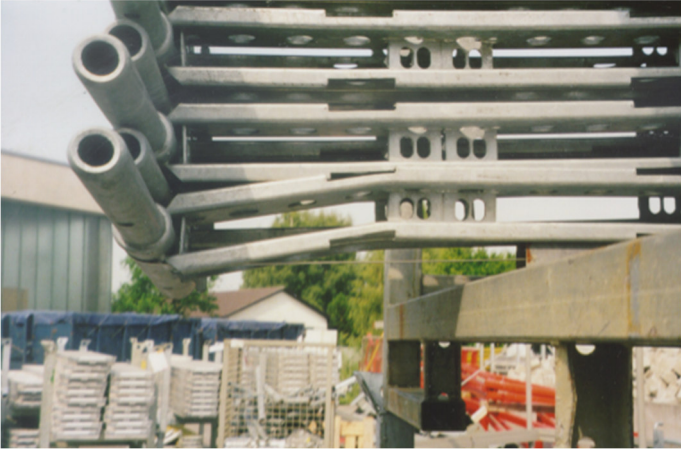

Keret sérülés	leírás	Instrukció	Fizetési kondíció	Típus
	<p><b>33.20.13 Fügőleges cső elhajlott</b></p> <ul style="list-style-type: none"> <li>■ Nincs horpadás a csőben &gt; 3,0 mm de ≤ 15 cm</li> <li>■ Vagy &gt; 15 cm</li> </ul>	  	 088244  	  
	<p><b>33.20.14 Járótábla kapcsoló profil elhajlott</b></p> <ul style="list-style-type: none"> <li>■ Járótábla behelyezhető de sérült a profil</li> <li>■ Járótábla behelyezése nem lehetséges</li> </ul>	  	 088244  	  

# PERI Bérleti kritériumok

## PERI UP homlokzati állványrendszerek











Keret sérülés	leírás	Instrukció	Fizetési kondíció	Típus
	<b>33.20.15 Járótábla kapcsoló profil eldeformálódott</b>			
	<b>33.20.16 Lemez elhajlott</b> <ul style="list-style-type: none"><li>■ Hegesztés nem sérült</li></ul>		 088244	

# PERI Bérleti kritériumok

## PERI UP homlokzati állványrendszerek



Keret sérülés	leírás	Instrukció	Fizetési kondíció	Típus
	<b>33.20.17 Hiányzó ütköző lemez</b>			
	<b>33.20.18 Függőleges csap elhajlott</b> <ul style="list-style-type: none"><li>■ Minden látható deformáció</li></ul>			

# PERI Bérleti kritériumok

## PERI UP homlokzati állványrendszerek











Függőlrgrs rúd UVE   UVM (116857   116855)	leírás	Instrukció	Fizetési kondíció	Típus
	<b>33.20.19 Korlátartó lemez elhajlott</b> <ul style="list-style-type: none"> <li>■ Ha lehetséges</li> </ul>			
	<ul style="list-style-type: none"> <li>■ Ha nem lehetséges</li> </ul>			
	<b>33.20.20 Csap deformálódott</b> <ul style="list-style-type: none"> <li>■ Minden látható deformáció</li> </ul>			

# PERI Bérleti kritériumok

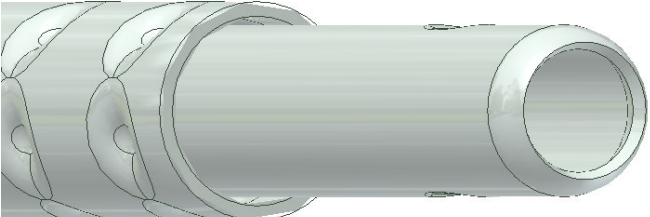
## PERI UP homlokzati állványrendszerek



Belső cső UV 165 (100220)	leírás	Instrukció	Fizetési kondíció	Típus
	<b>33.20.21 Koriáttartó lemez elhajlott</b>			
	<ul style="list-style-type: none"><li>■ Ha lehetséges</li></ul>			
	<ul style="list-style-type: none"><li>■ Ha nem lehetséges</li></ul>			
	<b>33.20.22 Csap deformálódott</b>			
	<ul style="list-style-type: none"><li>■ Minden látható deformáció</li></ul>			

# PERI Bérleti kritériumok

## PERI UP homlokzati állványrendszerek



### Járótábla heveder UHD

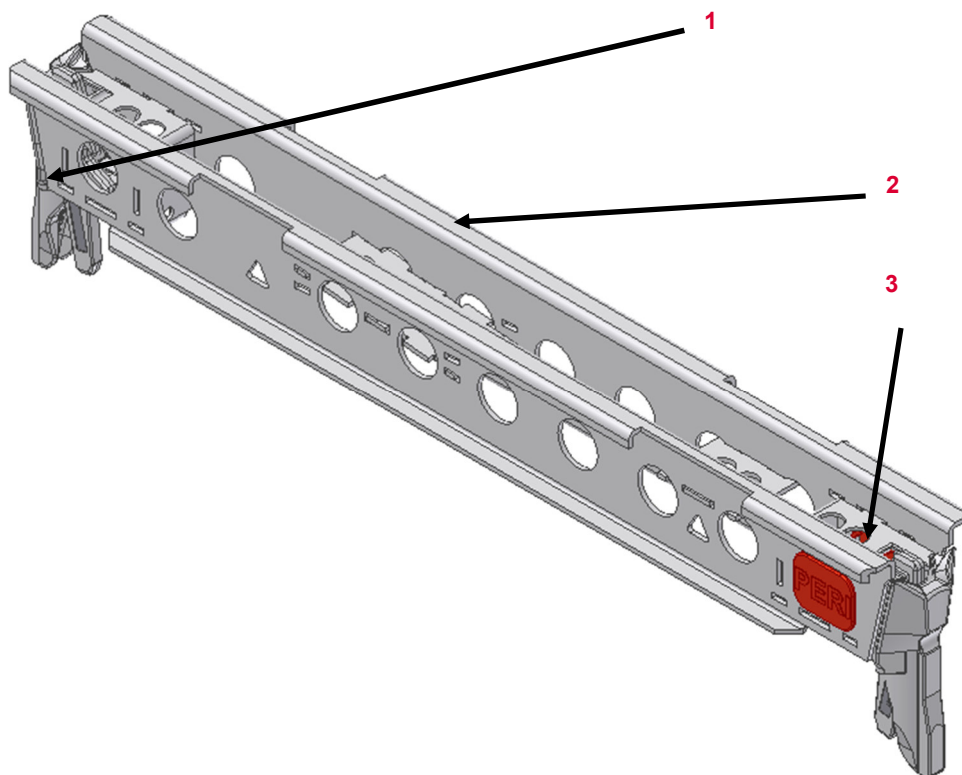

Sorsz..	leírás	Cikkszám
1	Ék	
2	Profil	
3	Ék ház	

Cikk	Cikkszám
Járótábla heveder UHD 72	100031
Járótábla heveder UHD 104	100039
Járótábla heveder UHD 150	100076
Járótábla heveder UHD 200	100079
Járótábla heveder UHD 250	100082
Járótábla heveder UHD 300	100085

# PERI Bérleti kritériumok

## PERI UP homlokzati állványrendszerek



Járótábla heveder UHD	leírás	Instrukció	Fizetési kondíció	Típus
-----------------------	--------	------------	-------------------	-------



### 33.20.23 Profil elhajlott

- > megengedett hajlás (L/300)



Cikk	Megengedett elhajlás
UHD 72	3 mm
UHD 104	4 mm
UHD 150	5 mm
UHD 200	7 mm
UHD 250	8 mm
UHD 300	10 mm



### 33.20.24 Ékház rongálódott

- Ha lehetséges



- Ha nem lehetséges













# PERI Bérleti kritériumok

## PERI UP homlokzati állványrendszerek



Járótábla heveder UHD	leírás	Instrukció	Fizetési kondíció	Típus
	33.20.25 Profil horpadása		 088244	
	33.20.26 Ék hiányzik   Ék ház sérült			

# PERI Bérleti kritériumok

## PERI UP homlokzati állványrendszerek



### Átlós merevítő UBF

Sorsz..      leírás      Cikkszám

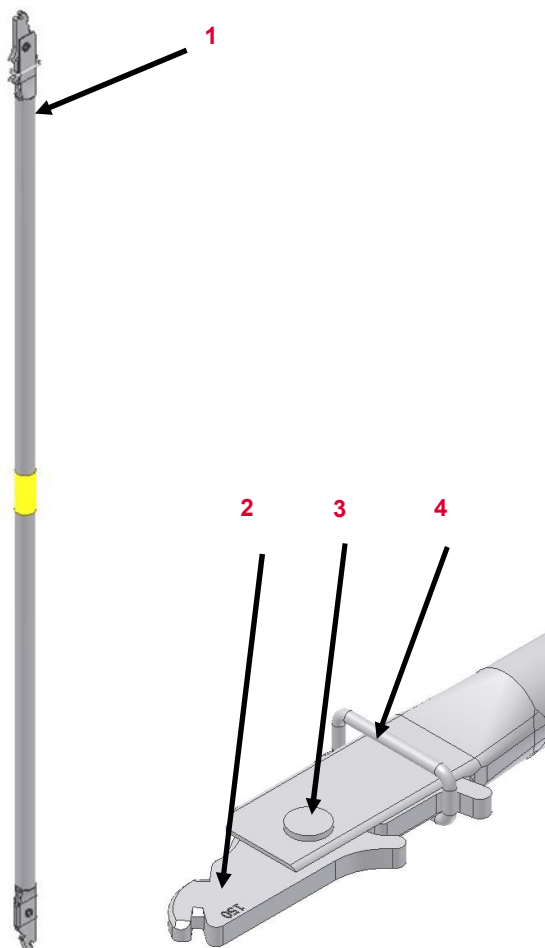

1	Csőprofil	
2	Rögzítő fej	
3	Félig üreges szegecs	100251
4	Biztosító gyűrű	100252

Cikk megnevezés	cikkszám
Átlós merevítő UBF 150/200	100247
Átlós merevítő UBF 200/200	100253
Átlós merevítő UBF 250/200	100257
Átlós merevítő UBF 300/200	100261

# PERI Bérleti kritériumok

## PERI UP homlokzati állványrendszerek



Átlós merevítő UBF	leírás	Instrukció	Fizetési kondíció	Típus
--------------------	--------	------------	-------------------	-------

### 33.20.27 Csőprofil elhajlott



- $\leq$  megengedett hajlás (L/500)
- Vagy  $>$  megengedett hajlás



Cikk	Megengedett hajlás
UBF 150/200	4 mm
UBF 200/200	5 mm
UBF 250/200	6 mm
UBF 300/200	7 mm



088244













### 33.20.28 Alsó vagy felső fej törött



# PERI Bérleti kritériumok

## PERI UP homlokzati állványrendszerek



Átlós merevítő UBF	leírás	Instrukció	Fizetési kondíció	Típus
	<p><b>33.20. Átlós fej</b></p> <ul style="list-style-type: none"> <li>■ Deformáció &gt; 5 mm</li> </ul>			
	<p><b>33.20.30 Átlós fej erősen szennyezett</b></p> <ul style="list-style-type: none"> <li>■ Ha tisztítható</li> <li>■ Ha nem tisztítható</li> </ul>	 	 	 

# PERI Bérleti kritériumok

## PERI UP homlokzati állványrendszerek



### Korlát UPG



Sorsz..

leírás

Cikkszám

1 Vég profil

2 csőprofil

Cikk

Cikkszám

Korlát UPG 72

107045

Korlát UPG 104

107050

Korlát UPG 150

100265

Korlát UPG 200

100266

Korlát UPG 250

100267

Korlát UPG 300

100268

Korlát UPG 400

100810

# PERI Bérleti kritériumok

## PERI UP homlokzati állványrendszerek



Korlát UPG	leírás	Instrukció	Fizetési kondíció	Típus
------------	--------	------------	-------------------	-------



### 33.20.31 Korlát elhajlott

- Nincs horpadás a profilban és  $\leq$  a megengedett hajlás ( $l/100$ )
- Vagy horpadás a profilon
- Vagy  $>$  megengedett hajlás ( $l/100$ )





Cikk	Megengedett hajlás
UPG 150	15 mm
UPG 200	20 mm
UPG 250	25 mm
UPG 300	30 mm
UPG 400	35 mm

# PERI Bérleti kritériumok

## PERI UP homlokzati állványrendszerek



Korlát UPG	leírás	Instrukció	Fizetési kondíció	Típus
	<b>33.20.32 Profil vége</b> <ul style="list-style-type: none"> <li>Hajlás szöge &lt; 45°</li> </ul>			
	<b>33.20.33 Profil vége erősen elhajlott</b> <ul style="list-style-type: none"> <li>Repedés az anyagban</li> <li>Vagy elhajlás szöge &gt; 45 °</li> </ul>	 	 	 

# PERI Bérleti kritériumok

## PERI UP homlokzati állványrendszerek



### Létrás feljáró UAL

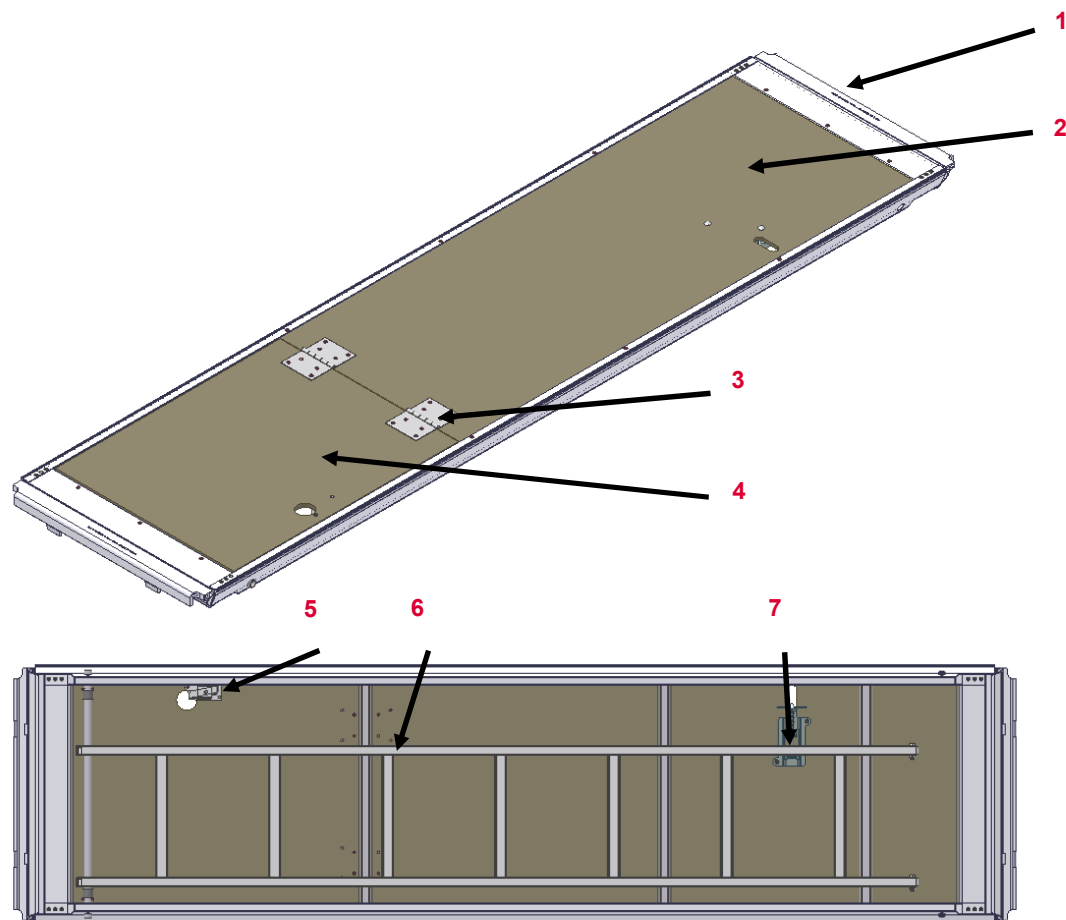

Sorsz..	leírás	Cikkszám
1	Rögzítő / tartó fül	114667
2	Járófelület	
3	Zsanér	100468
4	Ajtó	114671
5	Retesz	115566
6	Létra	100470
7	Rugós zár	126588











Cikk	Cikkszám
Létrás feljáró w. Létra UAL-2 64x250/3	114825
Létrás feljáró w. Létra UAL-2 64x300/3	114812
Létrás feljáró UAL-3 64x250/3K	126481
Létrás feljáró UAL-3 64x300/3K	126482
Létrás feljáró UAL-3 64x200/3K	126480
Létrás feljáró UAL-3 64x200/3	114811

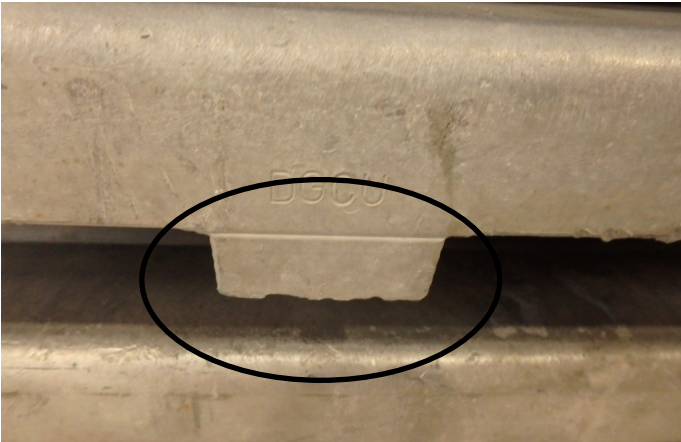

# PERI Bérleti kritériumok

## PERI UP homlokzati állványrendszerek

















Létrás feljáró UAL	leírás	Instrukció	Fizetési kondíció	Típus
	<p><b>33.20.34 Horpadás az alumínium profilon</b></p> <ul style="list-style-type: none"> <li>■ Létrás feljáró könnyen behelyezhető</li> <li>■ És profil éle nem sérült!</li> </ul>	 		
	<p><b>33.20.35 rögzítő fül</b></p> <ul style="list-style-type: none"> <li>■ Megrepedt</li> <li>■ Vagy roncsolódott</li> </ul>	  	  	  

# PERI Bérleti kritériumok

## PERI UP homlokzati állványrendszerek











Létrás feljáró UAL	leírás	Instrukció	Fizetési kondíció	Típus
	<b>33.20.36 Létra</b> <ul style="list-style-type: none"> <li>■ Repedés (létracsere)</li> </ul>			
	<ul style="list-style-type: none"> <li>■ Vagy hiányzik</li> </ul>			
	<ul style="list-style-type: none"> <li>■ Vagy élprofil horpadt (létracsere)</li> </ul>			
	<b>33.20.37 Lyuk a létrás feljárón</b>			

# PERI Bérleti kritériumok

## PERI UP homlokzati állványrendszerek

















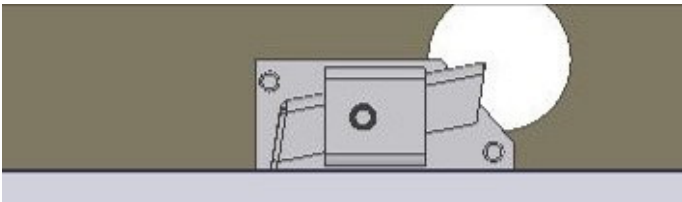

Létrás feljáró UAL	leírás	Instrukció	Fizetési kondíció	Típus
	<p><b>33.20.38 Hegesztés repedt az alátámasztásnál</b></p> <ul style="list-style-type: none"><li>■ Nem deformálódott a merevítés</li></ul>			
	<p><b>33.20.39 Hegesztés elrepedt / eltört</b></p> <ul style="list-style-type: none"><li>■ Merevítés deformálódott</li></ul>			

# PERI Bérleti kritériumok

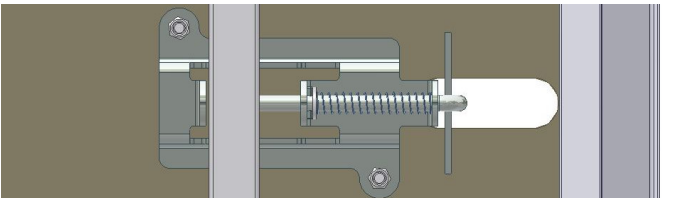
## PERI UP homlokzati állványrendszerek



Létrás feljáró UAL	leírás	Instrukció	Fizetési kondíció	Típus
	33.20.40 Lyuk a járófelületen / ajtó felületén			
	33.20.41 Zsanérok nem működnek		 089030	
	33.20.42 Retsz nem működik		 089024	
	33.20.43 Rugós zár nem működik			

# PERI Bérleti kritériumok

## PERI UP homlokzati állványrendszerek



### Lábdeszka UPT-3

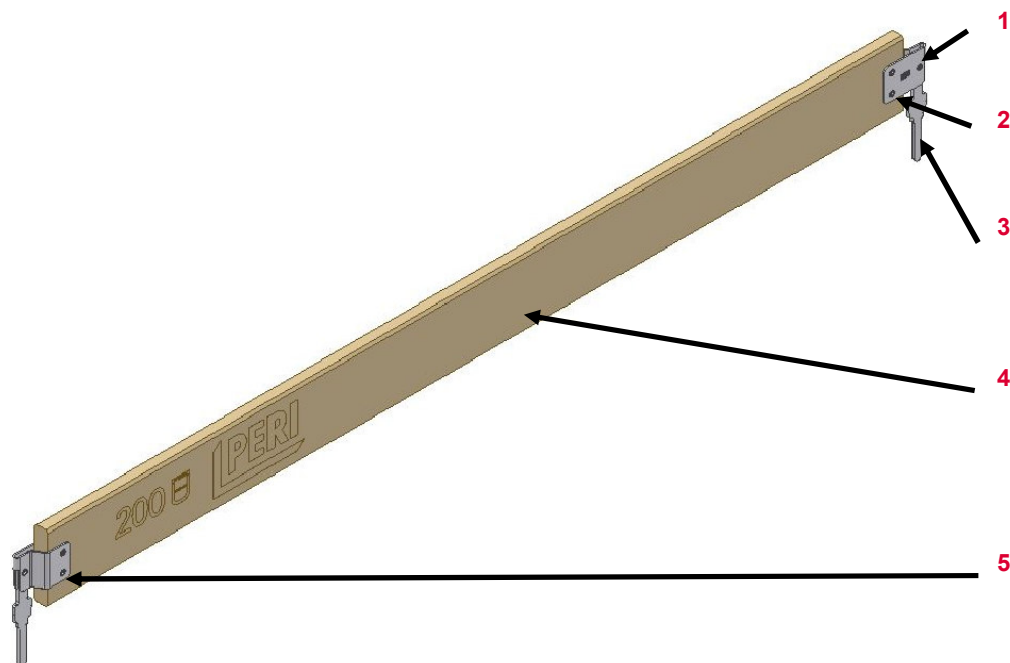













Sorsz..	leírás	Cikkszám
1	Szegecs 75x18	100136
2	Szegecs DIN 75x41	100384
3	Csap	125169
4	Lábdeszka	
5	Zsanér	108065

Cikk megnevezés	Cikkszám
Lábdeszka UPT-3 72	126858
Lábdeszka UPT-3 104	126868
Lábdeszka UPT-3 150	125172
Lábdeszka UPT-3 200	125173
Lábdeszka UPT-3 250	125174
Lábdeszka UPT-3 300	125175
Lábdeszka UPT-3 400	125176

# PERI Bérleti kritériumok

## PERI UP homlokzati állványrendszerek



Lábdeszka UPT-3	leírás	Instrukció	Fizetési kondíció	Típus
	33.20.44 Rögzítés sérült			
	33.20.45 Lábdeszka törött			
	33.20.46 Lábdeszka elhasználódott			

# PERI Bérleti kritériumok

## PERI UP homlokzati állványrendszerek



### Végkorlát UPX

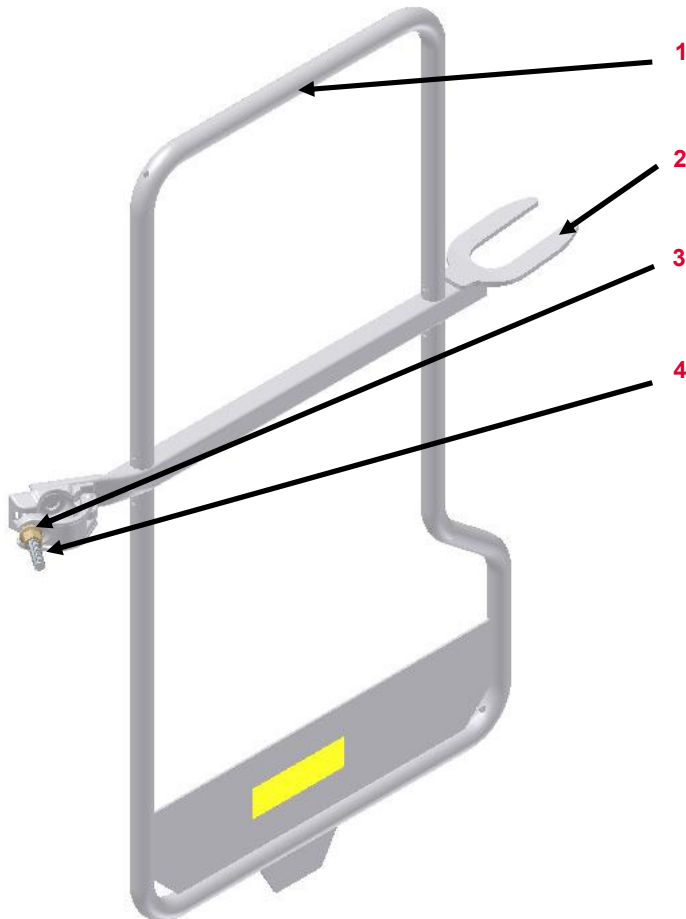









Sorsz..	leírás	Cikkszám
1	Védőkorlát	
2	Villa	
3	Anyá	710340
4	Kalapácsfejű csavar	710290

Cikk megnevezés	Cikkszám
Végkorlát UPX 32	101579
Végkorlát UPX 74	100444
Végkorlát UPX 104	100349

# PERI Bérleti kritériumok

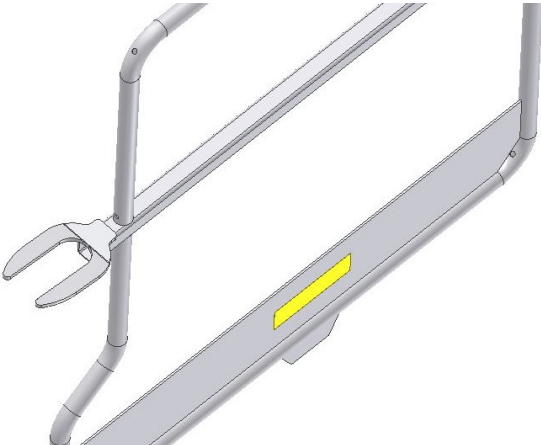
## PERI UP homlokzati állványrendszerek



Végkorlát UPX	leírás	Instrukció	Fizetési kondíció	Típus
	<b>33.20.47 Villa elgörbült</b>  ■ Eltérés ≤ 20 mm		 088244	
	<b>33.20.48 Láblemez hajlott / horpadt</b>	 	 088244	



# PERI Bérleti kritériumok

## PERI UP homlokzati állványrendszerek



Járótábla csap UES (101576)	leírás	Instrukció	fizetési kondíció	Típus
-----------------------------	--------	------------	-------------------	-------



33.20.49 Hiányzó hasított ék



710910 (Hasított ék)



089402



33.20.50 Ék elhajlott vagy hiányzik



# PERI Bérleti kritériumok

## PERI UP homlokzati állványrendszerek



Alap gerenda UVA (101702; 100870)	leírás	Instrukció	fizetési kondíció	Típus
-----------------------------------	--------	------------	-------------------	-------



33.20.51 Hiányzó hasított ék



710910 (Hasított ék)



089042



33.20.52 Hiányzó csapos elem

- Alapgerenda nem sérült



101689 (Csapos elem)



















089036



# PERI Bérleti kritériumok ikonok



Ikon	magyarázat	Ikon	magyarázat	Ikon	magyarázat
	Nem OK — selejtezendő		Ügyfélnek leszámházandó		Optikai kár
	OK– marad a bérleti parkban		Nincs számlázás		Funkcionális sérülés
	Selejt anyag – biztonsági okokból az anyagot tilos kiadni		Anyagot levágni		Funkcionális sérülés — anyag kiadása nem engedélyezett
	Javítás az előírások szerint		Anyagot megjelölni		Statikai sérülés — anyag kiadása nem engedélyezett
	Hideg egyengetés — utána a varratokat és a környékét ellenőrzni kell		Sérült anyag cseréje		
	Javítás gazdaságosság függvényében		Hiányzó anyag cseréje		
	Megtisztítani az anyagot				