

PERI bérleti kritériumok

LGS védőtető

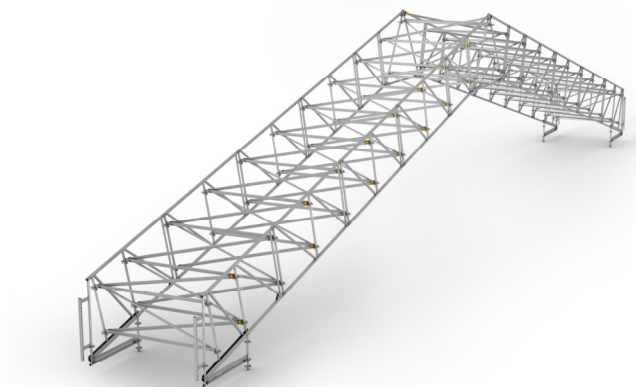

Kapcsolat

PERI kft,
zsuluzatok, állványzatok,
mérnöki szolgáltatás

H-1186 Budapest
Zádor u. 9.
Tel.: +36-1-296-09-60

| Tartalom | Oldal | Változtatások | Dátum Által | Oldal |
|--|-------|----------------------------|---------------|-------|
| LGS Elemek | 2 | Új változat | 06/2017 fw | |
| LGS görgő sín URT | 8 | LGS 75 hozzáadott termékek | 11/2019 fw | 2; 24 |
| UP kerék fékezetlen UEW | 15 | RC fordítása | 01/2024 V2A | |
| Kéder Sín Kéder gerinc Sín Eresz Sín URK | 16 | | | |
| Keder Kapcsoló URK URV | 18 | | | |
| Ponyva orsó URG | 20 | | | |
| Orsó csatlakozó URG | 21 | | | |
| UP LGS csatlakozó URP | 22 | | | |
| Magyarázat | 25 | | | |

PERI bérleti kritériumok

LGS védőtető



| LGS elemek | Sorsz. | Leírás | Cikkszám |
|------------|--------|--------|----------|
|------------|--------|--------|----------|

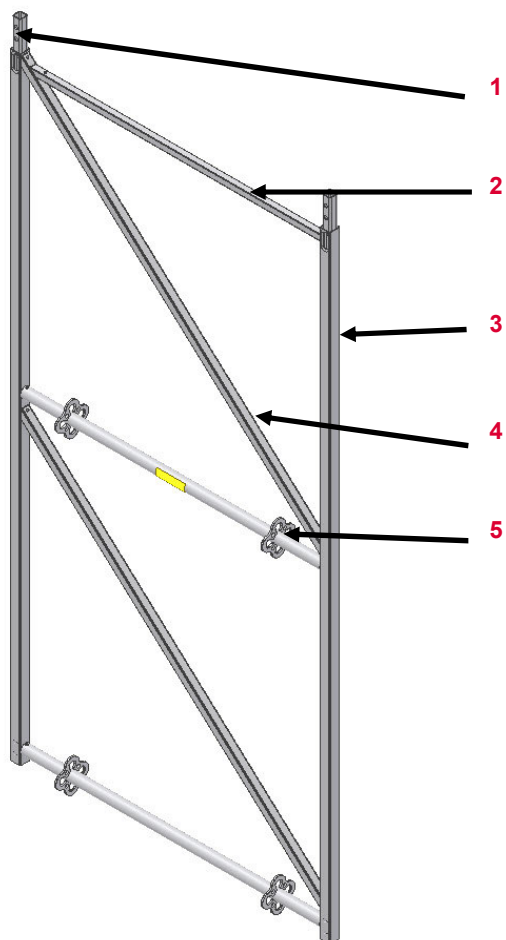



| | |
|---|----------------|
| 1 | Csatlakozó |
| 2 | Vertikális cső |
| 3 | Belső cső |
| 4 | Diagonális cső |
| 5 | Rozetta |

| Megnevezés | |
|--------------------------------|--------|
| LGS– Standard elem URB 150/300 | 104768 |
| LGS– Eresz elem URB 300/150 | 126483 |
| LGS– Köztes elem URB 150/150 | 104792 |
| LGS– Közbenső elem URB 150/150 | 116122 |
| LGS– Oromelem URR 150 | 104769 |
| LGS– Végelem URB 150 | 105334 |
| LGS - Alap elem URB 300/75 | 135766 |
| LGS - Eresz elem URB 300/75 | 135793 |
| LGS - Köztes elem URB 150/75 | 135773 |
| LGS - Oromelem URR 75 | 135782 |

PERI bérleti kritériumok

LGS védőtető



| LGS elemek | Leírás | Instrukció | Fizetési kondíció | Típus |
|--|--|------------|-------------------|-------|
|  | Csomópont görbült | | | |
| | <ul style="list-style-type: none"> Ha lehetséges a kapcsolatot létrehozni és nincs törés a cink felületen | | | |
| | <ul style="list-style-type: none"> Ha nem lehetséges a kapcsolat | | | |
| | <ul style="list-style-type: none"> Ha törés van a cink felületen | | | |
|  | Rozetta görbült | | | |
| | <ul style="list-style-type: none"> ≤ 20 mm | | | |
| | <ul style="list-style-type: none"> Ha > 20 mm | | | |
| | <ul style="list-style-type: none"> Ha repedt vagy törött a rozetta | | | |

PERI bérleti kritériumok

LGS védőtető



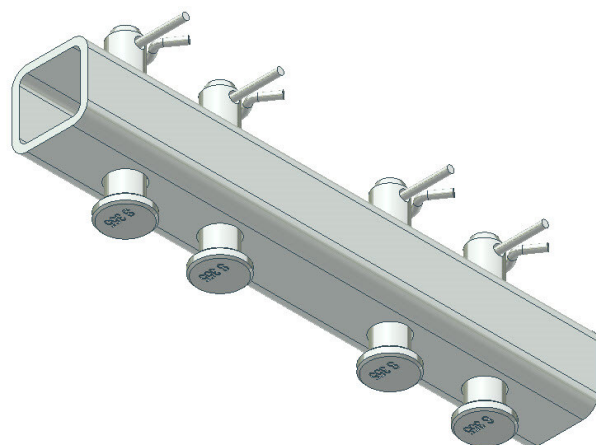

| LGS Kapcsoló URC (115978) | Leírás | Instrukció | Fizetési kondíció | Típus |
|---------------------------|--------|------------|-------------------|-------|
|---------------------------|--------|------------|-------------------|-------|



Csap / sasszeg

- hiányzik
- sérülés miatt használhatatlan

 106031 (Csap 16*70)
018060 (Sasszeg 4/1)

 106031 (Csap 16*70)
018060 (Sasszeg 4/1)

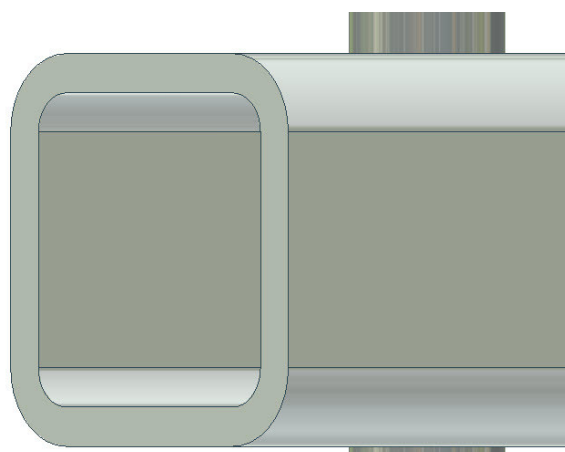

Cső görbült / horpadt

- Kapcsolat még lehetséges
- Kapcsolat nem lehetséges a továbbiakban
- Törés a cink felületben



PERI bérleti kritériumok

LGS védőtető



| Kiegészítők URS (105399; 104771; 104770) | Leírás | Instrukció | Fizetési kondíció | Típus |
|--|--------|------------|-------------------|-------|
|--|--------|------------|-------------------|-------|



Sín görbült

- Ha lehetséges a kapcsolatot létrehozni
- Ha nem lehetséges létrehozni
- Ha törés van a cink felületen



Rozetta görbült











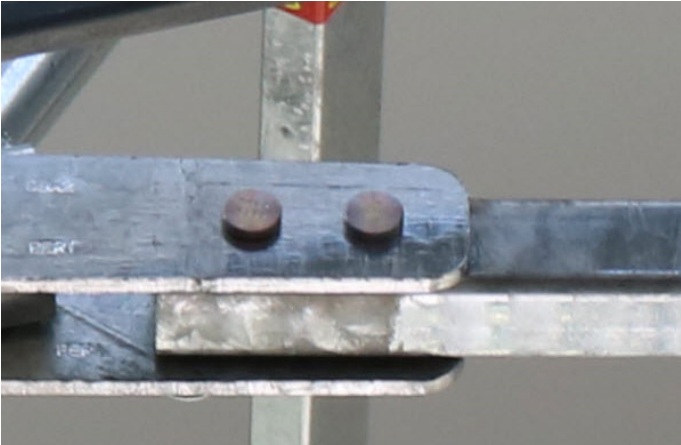

- ≤ 20 mm
- vagy > 20 mm
- Vagy törés/repedés van a rozettán

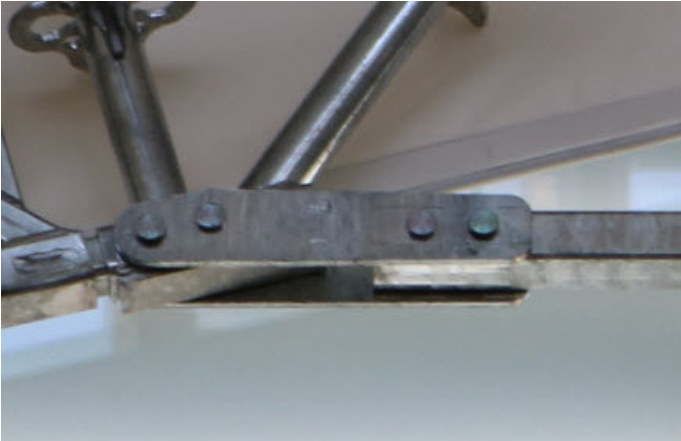

PERI bérleti kritériumok

LGS védőtető



| Oromkapocs UR (128334; 104778; 104981) | Leírás | Instrukció | Fizetési kondíció | Típus |
|--|--|---|---|---|
|  | Csavar Sasszeg Csapok | | | |
| | <ul style="list-style-type: none"> ■ Hiányzik |  |  |  |
| | <ul style="list-style-type: none"> ■ Ha használhatatlan sérülés miatt |  |  |  |
|  | Összefogó elgörbült | | | |
| | <ul style="list-style-type: none"> ■ Ha a javítás lehetséges |  |  |  |
| | <ul style="list-style-type: none"> ■ Ha a javítása nem lehetséges |  |  |  |

PERI bérleti kritériumok

LGS védőtető



| UP LGS Gördítőmű (104777) | Leírás | Instrukció | Fizetési kondíció | Típus |
|---------------------------|--|--|-------------------|-------|
| | Kerék elhajlott | <ul style="list-style-type: none"> A funkcióját betölti, a sérülés nem korlátozza és az emelőfunkció nem korlátozott. | | |
| | <ul style="list-style-type: none"> Korlátozottá vált bármely működése | | 104776 (kerék) | |
| | Csavar Sasszeg | <ul style="list-style-type: none"> Hiányzik | | |
| | <ul style="list-style-type: none"> Használhatatlan sérülés miatt | | | |

PERI bérleti kritériumok

LGS védőtető



LGS görgő sín alu URT

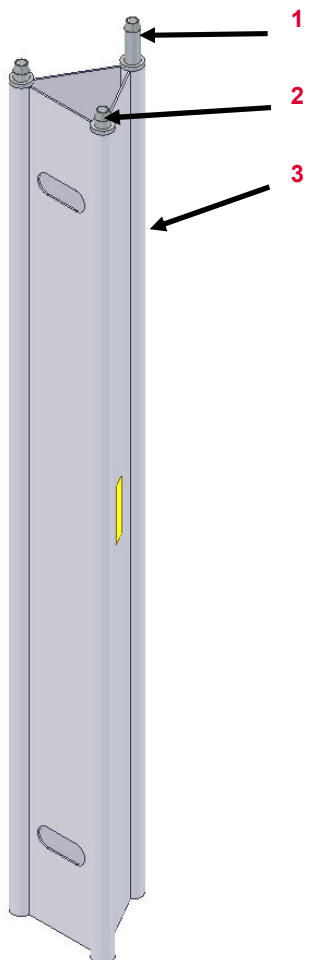

| Sorsz. | Leírás | Cikkszám |
|--------|-----------------|----------|
| 1 | Kapcsoló hosszú | 104800 |
| 2 | Kapcsoló rövid | 104848 |
| 3 | Vezető sín | |















Megnevezés

| | |
|----------------------|--------|
| Görgősín alu URT 150 | 104790 |
| Görgősín alu URT 200 | 104791 |
| Görgősín alu URT 250 | 104796 |
| Görgősín alu URT 300 | 104797 |

PERI bérleti kritériumok

LGS védőtető



| Alu vezetősin | Leírás | Instrukció | Fizetési kondíció | Típus |
|--|---|---|---|---|
|  | Kapcsoló <ul style="list-style-type: none"> ■ Hiányzik |  |  |  |
| | <ul style="list-style-type: none"> ■ Vagy sérült külső behatás miatt |  |  |  |
|  | Vezetősín görbült <ul style="list-style-type: none"> ■ Görgő még mozgatható |  |  |  |
| | <ul style="list-style-type: none"> ■ A görgő a továbbiakban már nem mozgatható |  |  |  |

PERI bérleti kritériumok

LGS védőtető



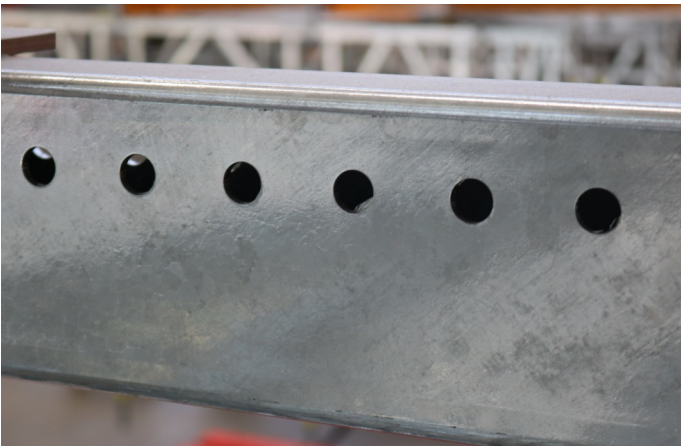







| Sín lef. tartó, vez. sín, heveder (105394 115018 105390 105386) Leírás | Instrukció | Fizetési kondíció | Típus |
|--|---------------------|-------------------|---------------------|
|  <p>Csomópont görbült, horpadt</p> <ul style="list-style-type: none"> ■ Fügőleges csövek behelyezése még lehetséges ■ Ha a továbbiakban nem lehetséges | <p>✓</p> <p>☒ ☒</p> | <p>☒</p> <p>☒</p> | <p>👁️</p> <p>⚙️</p> |
|  <p>Furat átmérő deformált, megnőtt</p> <ul style="list-style-type: none"> ■ $\varnothing > 18 \text{ mm}$ | <p>☒ ☒</p> | <p>☒</p> | <p>⚙️</p> |

PERI bérleti kritériumok

LGS védőtető











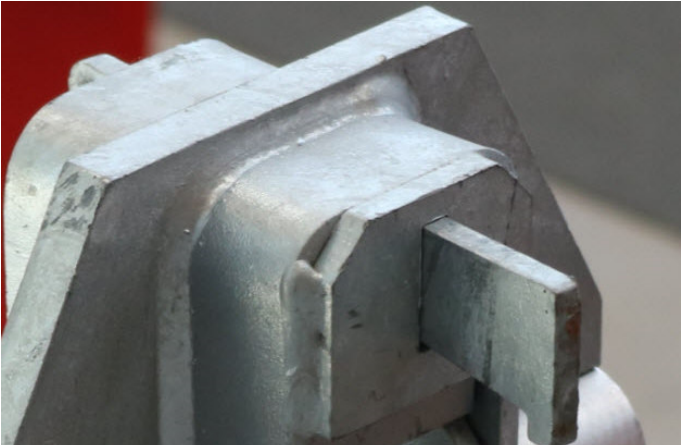

| LGS-URF Sínlefogó (104853) | Leírás | Instrukció | Fizetési kondíció | Típus |
|---|--|--|--|--|
|  | Csomópont görbült <ul style="list-style-type: none"> ■ Ha lehetséges a sín behelyezése ■ Ha a továbbiakban nem lehetséges |   |   |   |
| | Sasszeg hiányzik |  | 022230 (Sasszeg) |  |

PERI bérleti kritériumok

LGS védőtető



| LGS ütköző URA-2 (118022) | Leírás | Instrukció | Fizetési kondíció | Típus |
|--|--|--|---|---|
|  | <p>Ék hiányzik</p> |  |  |  |
|  | <p>Elem görbült</p> <ul style="list-style-type: none"> ■ Ha funkcióját betölti |  Egyengetés után a funkció működését ellenőrizni kell |  |  |
| | <ul style="list-style-type: none"> ■ Ha a funkcióját nem tölti be, javíthatatlan |  |  |  |

PERI bérleti kritériumok

LGS védőtető

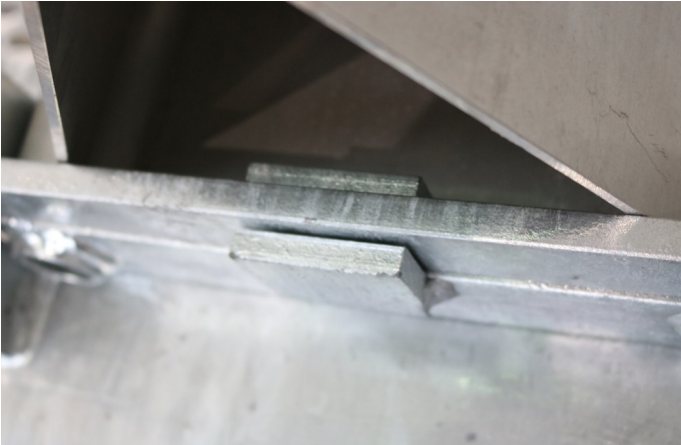
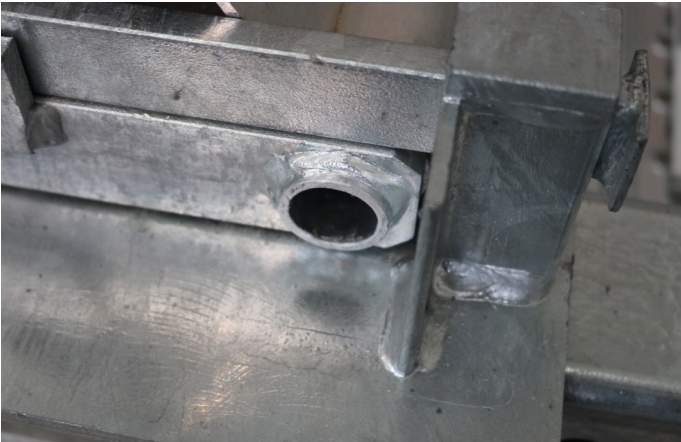

| LGS sín végelem URD (104852) | Leírás | Instrukció | Fizetési kondíció | Típus |
|--|---|------------|-------------------|-------|
|  | Lap görbült | | | |
| | <ul style="list-style-type: none"> ■ Ha funkcióját még betölti egyengetés után | | | |
| | <ul style="list-style-type: none"> ■ Ha a továbbiakban nem használható | | | |
| | <ul style="list-style-type: none"> ■ Ha repedés van a hegesztésben javítás előtt vagy után | | | |
|  | Cső görbült deformált | | | |
| | <ul style="list-style-type: none"> ■ Ha lehetséges javítani (a cső egyengetés után csatlakoztatható) | | | |
| | <ul style="list-style-type: none"> ■ Ha lehetetlen a javítása | | | |
| | <ul style="list-style-type: none"> ■ Ha sérült a hegesztés vagy a cink felület | | | |

PERI bérleti kritériumok

LGS védőtető



| LGS Retszeses rögzítő URS (105398) | Leírás | Instrukció | Fizetési kondíció | Típus |
|------------------------------------|--------|------------|-------------------|-------|
|------------------------------------|--------|------------|-------------------|-------|



Csap / Sasszeg

- Hiányzik



106191 (Csavar 24X105)
 106194 (Csavar 16x105)
 022230 (Sasszeg 5/1)
 018060 (Sasszeg 4/1)



- Ha nem használható sérülés miatt



106191 (Csavar 24X105)
 106194 (Csavar 24X105)
 022230 (Sasszeg 5/1)
 018060 (Sasszeg 4/1)

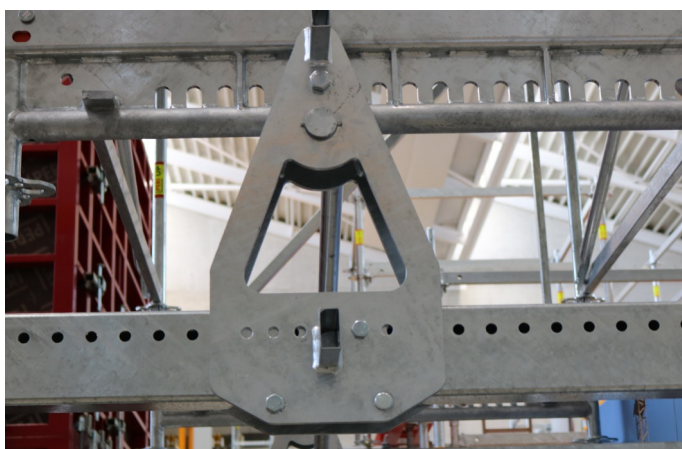

Görbület / egyéb sérülés

- Ha egyengetéssel javítható















- Ha a továbbiakban nem használható



PERI bérleti kritériumok

LGS védőtető



| UP kerék fékezetlen UEW (104854) | Leírás | Instrukció | Fizetési kondíció | Típus |
|----------------------------------|---|---|---|---|
| | Gördítőkerék sérülése | <ul style="list-style-type: none"> ■ Ha kisebb egyenetlenséggel (Görgő könnyen forgatható)  |  |  |
| | <ul style="list-style-type: none"> ■ Ha a továbbiakban nem lehetséges a funkció betöltése |   |  |  |
| | Gördítőkerék | <ul style="list-style-type: none"> ■ Kopott  057164 |  |  |
| | <ul style="list-style-type: none"> ■ Sérülés általi behatás miatt (funkcióját nem tölti be pl. görgő egyenetlen futás) |  057164 |  |  |

PERI bérleti kritériumok

LGS védőtető



LGS Kéder Sín | Kéder gerinc Sín | Eresz Sín

Sorsz.

Leírás

Cikkszám



1

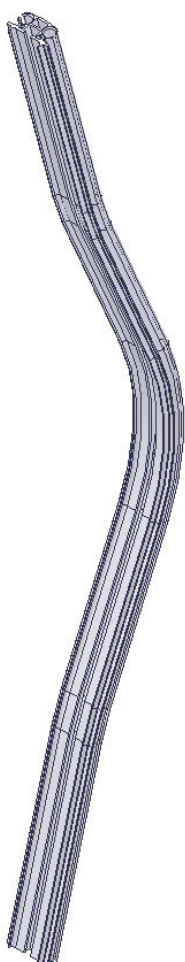

2

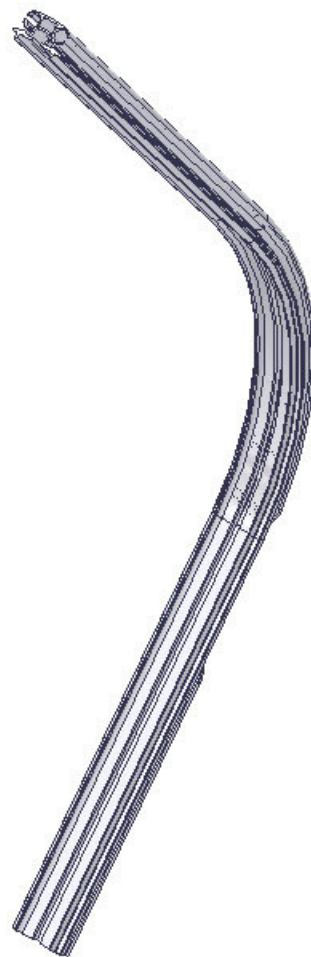

3

1

Kéder Sín

2

Kéder gerinc Sín

3

Eresz Sín

Megnevezés

| | |
|------------------------------|--------|
| LGS Kéder Sín URK 150 | 127501 |
| LGS Kéder Sín URK 300 | 127500 |
| LGS Kéder Sín URK 600 | 126071 |
| LGS Kéder gerinc Sín URK 150 | 126051 |
| LGS Eresz Sín URK | 126491 |

PERI bérleti kritériumok

LGS védőtető



| LGS Kédersín Kéder gerinc sín Eresz sín | Leírás | Instrukció | Fizetési kondíció | Típus |
|---|--------|------------|-------------------|-------|
|---|--------|------------|-------------------|-------|



Sín elgörbült

- Kéder felhelyezése még lehetséges
- Ha a kéder felhelyezése már nem lehetséges



Védő profil görbült | horpadt



- Kéder felhelyezése még lehetséges
- Ha a kéder felhelyezése már nem lehetséges



PERI bérleti kritériumok

LGS védőtető











| LGS Kéder kapcsoló URK (125166) | Leírás | Instrukció | Fizetési kondíció | Típus |
|--|--|---|-------------------|---------------------|
|  | <p>Karom görbült</p> <ul style="list-style-type: none"> ■ Ha a sínre történő kapcsolása lehetséges ■ Ha továbbiakban a kapcsolás nem lehetséges | <p>✓</p> <p>☰ 125165 (köröm horonnyal) ☰ 125162 (köröm horony nélkül)</p> | <p>☰</p> <p>☰</p> | <p>👁️</p> <p>⚙️</p> |
|  | <p>Csavarozás</p> <ul style="list-style-type: none"> ■ Hiányzik vagy sérült | <p>🔧 126001 (csavar)</p> | <p>☰</p> | <p>⚙️</p> |

PERI bérleti kritériumok

LGS védőtető



| LGS Kéder kapcsoló URV (126009) | Leírás | Instrukció | Fizetési kondíció | Típus |
|---------------------------------|--|---|---|---|
| | <p>Kalapácsfejű csavar anya</p> <ul style="list-style-type: none"> ■ hiányzik ■ Vagy sérült behatás miatt | <p>  131316 (kalapács fejű csavar) 710330 (anya) </p> <p>  131316 (kalapács fejű csavar) 710330 (anya) </p> | <p>  </p> <p>  </p> | <p>  </p> <p>  </p> |
| | <p>Sín görbült</p> | <p>  </p> | <p>  </p> | <p>  </p> |

PERI bérleti kritériumok

LGS védőtető



| LGS Ponyva orsó (126484; 126485) | Leírás | Instrukció | Fizetési kondíció | Típus |
|---|------------------------|--|---|---|
|  | Tárcsa használhatatlan |  126949 |  |  |

PERI bérleti kritériumok

LGS védőtető



| LGS Orsó csatlakozó URG (126486) | Leírás | Instrukció | Fizetési kondíció | Típus |
|----------------------------------|--------|------------|-------------------|-------|
|----------------------------------|--------|------------|-------------------|-------|

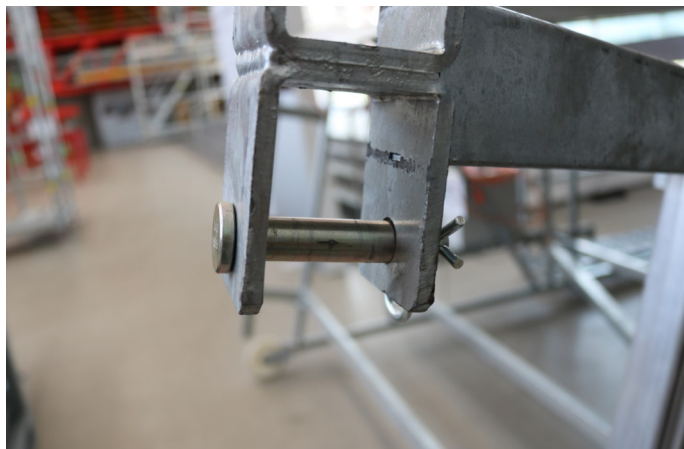

csavar | sasszeg | csap | anya
hiányzik



106031 (csap 16*70)
018060 (sasszeg 4/1)
126924 (csavar M12*130)
710330 (anya M12)



Kapcsolati pont elgörbült



PERI bérleti kritériumok

LGS védőtető



| UP LGS Csatlakozó URP (105366) | Leírás | Instrukció | Fizetési kondíció | Típus |
|--------------------------------|--------|------------|-------------------|-------|
|--------------------------------|--------|------------|-------------------|-------|



Rozetta görbült

- ≤ 20 mm
- ha > 20 mm
- Törés a rozettán

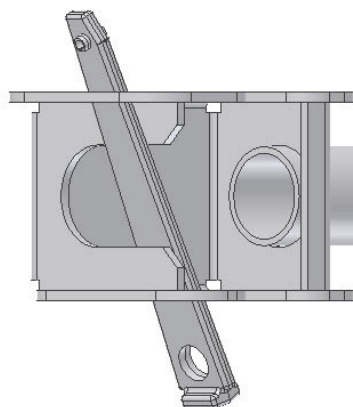

Ék

- hiányzik
- Nem mozgatható



024250 (Vario K ék)
105365 (feszítőhüvely)

024250 (Vario K ék)
105365 (feszítőhüvely)



PERI bérleti kritériumok

LGS védőtető



LGS gördítő URS 75 (135801)

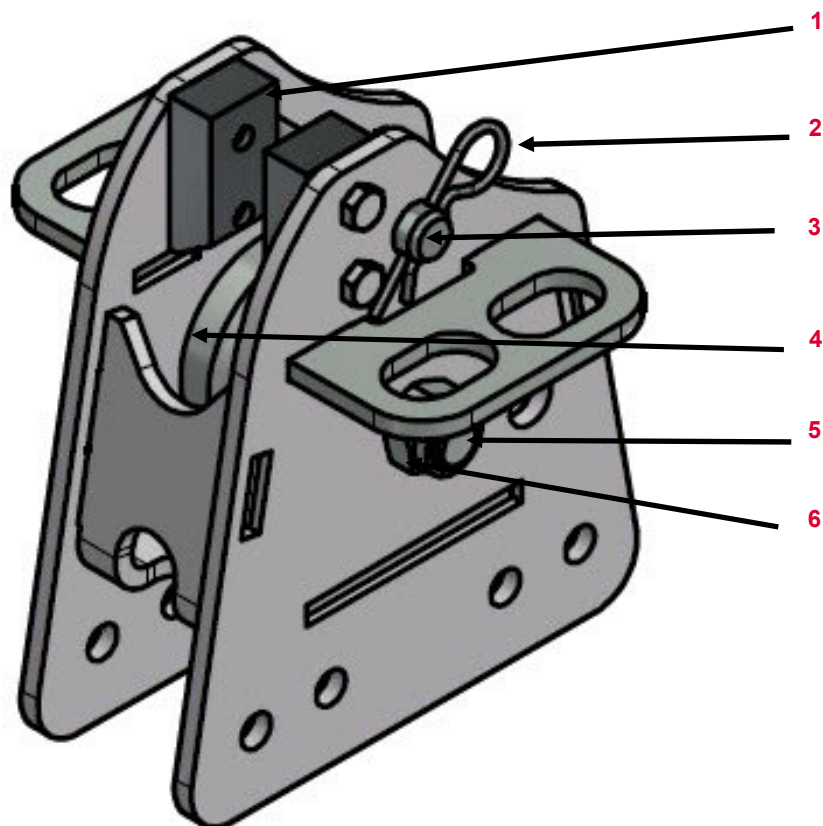









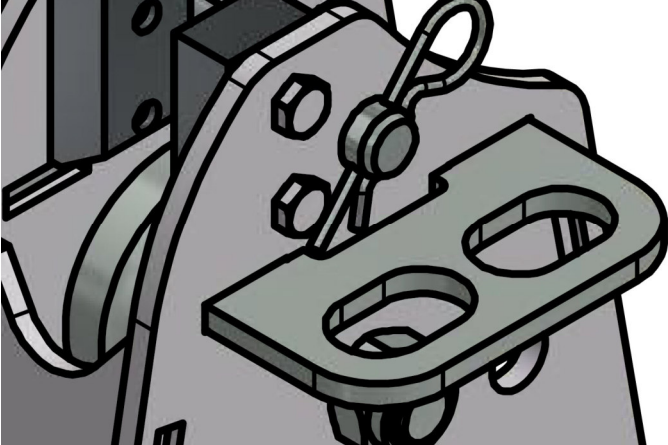



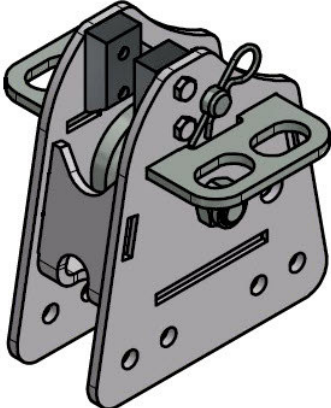

| Sorsz. | Leírás | Cikkszám |
|--------|---------|----------|
| 1 | Ütköző | 104999 |
| 2 | Sasszeg | 022230 |
| 3 | Csap | 106191 |
| 4 | Görgő | 135795 |
| 5 | Csavar | 109612 |
| 6 | Anyá | 130342 |

PERI bérleti kritériumok

LGS védőtető



















| LGS Gördítő URS 75 (135801) | Leírás | Instrukció | Fizetési kondíció | Típus |
|---|---|--|--|--|
|  | Csap Sasszeg Csavar Anya | | | |
| | <ul style="list-style-type: none"> ■ Hiányzik ■ Behatás miatt sérült |   |   |   |
|  | Görbült | | | |
| | <ul style="list-style-type: none"> ■ Ha lehetséges az egyengetése ■ Ha nem lehetséges a javítás |    |   |   |

PERI bérleti kritériumok

Magyarázat



| Ikon | Jelentés | Ikon | Jelentés | Ikon | Jelentés |
|---|--|--|-------------------------|---|--|
|  | Nem OK — kicselezendő |  | Ügyfélnek leszámházandó |  | Optikai kár |
|  | OK– marad a bérleti parkban |  | Nincs számlázás |  | Funkcionális sérülés |
|  | Selejt anyag – biztonsági okokból az anyagot tilos kiadni |  | Anyagot levágni |  | Funkcionális sérülés — anyag kiadása nem engedélyezett |
|  | Javítás az előírások szerint |  | Anyagot megjelölni |  | Statikai sérülés — anyag kiadása nem engedélyezett |
|  | Hideg egyengetés — utána a varratokat és a környékét ellenőrzni kell |  | Sérült anyag cseréje | | |
|  | Javítás gazdaságosság függvényében |  | Hiányzó anyag pótlása | | |
|  | Megtisztítani az anyagot | | | | |

PERI bérleti kritériumok

LGS védőtető



| GT 24 Schalungsträger | Sorsz. | Leírás | Cikkszám |
|-----------------------|--------|--------|----------|
| | 1 | 1 | |
| | 2 | 2 | |
| | 3 | 3 | |
| | 4 | 4 | |
| | | | |
| | | | |
| | | | |

PERI bérleti kritériumok

LGS védőtető



| Schaden | Leírás | Instrukció | Fizetési kondíció | Típus |
|---------|--------|------------|-------------------|-------|
|---------|--------|------------|-------------------|-------|

PERI bérleti kritériumok

LGS védőtető



| Nr. | Description | Item Numer |
|-----|---------------------|------------|
| 1 | Gurtholz | keine |
| 2 | Strebe | keine |
| 3 | Stahlkappe verzinkt | 726041 |
| 4 | Stahl-Rohniet | 726040 |

| Schaden | Description | Instruction | Billing Condition | Type |
|---------|-------------|-------------|-------------------|------|
|---------|-------------|-------------|-------------------|------|

PERI bérleti kritériumok

LGS védőtető



Kapcsolat

**PERI kft,
zsaluzatok, állványzatok,
mérnöki szolgáltatás**

H-1186 Budapest
Zádor u. 9.
Tel.: +36-1-296-09-60

| Inhalt | Seite |
|--------|-------|
| | |
| | |
| | |
| | |

| Inhalt | Seite |
|--------|-------|
| | |
| | |
| | |
| | |

PERI bérleti kritériumok

LGS védőtető



Kapcsolat

PERI kft,
zsaluzatok, állványzatok,
mérnöki szolgáltatás

H-1186 Budapest
Zádor u. 9.
Tel.: +36-1-296-09-60

| Vorgenommene Änderungen | Datum Kürzel, Wer | Seite |
|-------------------------|---------------------|-------|
| Neuerstellung Layout | 07/2015 rf | |
| | | |
| | | |
| | | |
| | | |
| | | |
| | | |
| | | |
| | | |
| | | |

| Vorgenommene Änderungen | Datum Kürzel, Wer | Seite |
|-------------------------|---------------------|-------|
| Neuerstellung Layout | 07/2015 rf | |
| | | |
| | | |
| | | |
| | | |
| | | |
| | | |
| | | |
| | | |
| | | |

PERI bérleti kritériumok

LGS védőtető



Kapcsolat

**PERI kft,
zsaluzatok, állványzatok,
mérnöki szolgáltatás**

H-1186 Budapest
Zádor u. 9.
Tel.: +36-1-296-09-60

| Inhalt | Seite |
|--------|-------|
| | |
| | |
| | |
| | |
| | |
| | |
| | |

| Inhalt | Seite |
|--------|-------|
| | |
| | |
| | |
| | |
| | |
| | |
| | |

Ab hier folgen die Seiten für die Schäden auf Basis der Gestaltungsvorlage für eine Zeile.

Die Abstände der Zeilen sind dadurch verschiebbar.

PERI bérleti kritériumok

LGS védőtető



| Schaden Xyyyyy | Leírás | Instrukció | Fizetési kondíció | Típus |
|------------------|--------|------------|-------------------|-------|
| | | | | |
| | | | | |

PERI bérleti kritériumok

LGS védőtető



| Schaden Xyyyyy | Leírás | Instrukció | Fizetési kondíció | Típus |
|------------------|--------|------------|-------------------|-------|
| | | | | |
| | | | | |
| | | | | |

PERI bérleti kritériumok

LGS védőtető



| Schaden Xyyyyy | Leírás | Instrukció | Fizetési kondíció | Típus |
|------------------|--------|------------|-------------------|-------|
| | | | | |
| | | | | |
| | | | | |
| | | | | |

Ab hier folgen die Seiten für die Schäden auf Basis unterschiedlicher Gestaltungsvorlagen:

1 Zeile, 2 Zeilen, 3 Zeilen und 4 Zeilen

Die Abstände der Zeilen sind jeweils nicht verschiebbar.

PERI bérleti kritériumok

LGS védőtető



| Schaden Xyyyyy | Leírás | Instrukció | Fizetési kondíció | Típus |
|------------------|--------|------------|-------------------|-------|
| | | | | |

PERI bérleti kritériumok

LGS védőtető



| Schaden | Leírás | Instrukció | Fizetési kondíció | Típus |
|---------|--------|------------|-------------------|-------|
| | | | | |
| | | | | |

PERI bérleti kritériumok

LGS védőtető



| Schaden | Description | Instruction | Billing condition | Type |
|---------|-------------|-------------|-------------------|------|
| | | | | |
| | | | | |
| | | | | |

PERI bérleti kritériumok

LGS védőtető



| Schaden | Description | Instruction | Billing condition | Type |
|---------|-------------|-------------|-------------------|------|
| | | | | |
| | | | | |
| | | | | |
| | | | | |

