

PERI Bérleti kritériumok

DOMINO

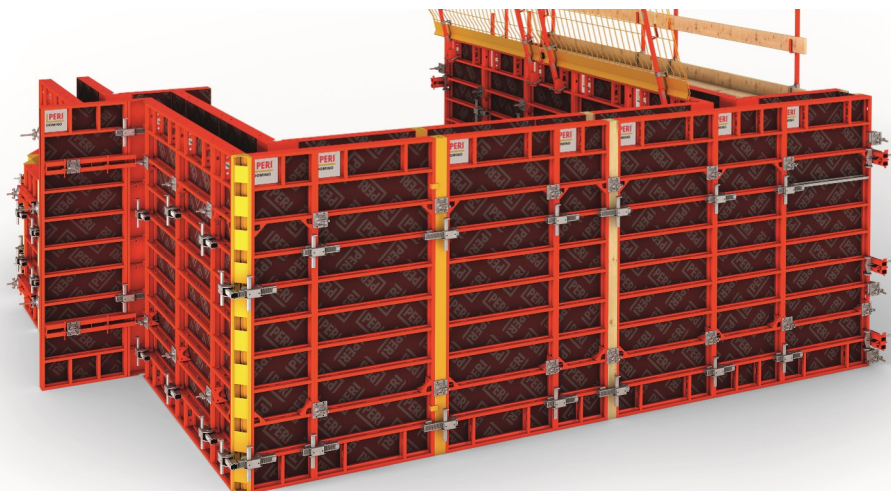

Kapcsolat

PERI kft.
Zsaluzatok, állványzatok,
mérnöki szolgáltatás

H-1181 Budapest,
Zádor u. 9.
Tel.: +36-1-296-09-60
www.peri.hu

Tartalom	Oldal	Változások	Dátum ü	Oldal
Keret	2	Új verzió	03/2021 Sz.L.	
Csuklós sarok	12			
Falbetét	15			
DSE kizsaluzó elem	18			
Külső sarok	22			
Végzsaluzó elem	24			
Kiegészítők	28			
Magyarázat	35			

PERI Bérleti kritériumok

DOMINO



Domino keretváz elemei

Sorsz. Megnevezés Cikkszám

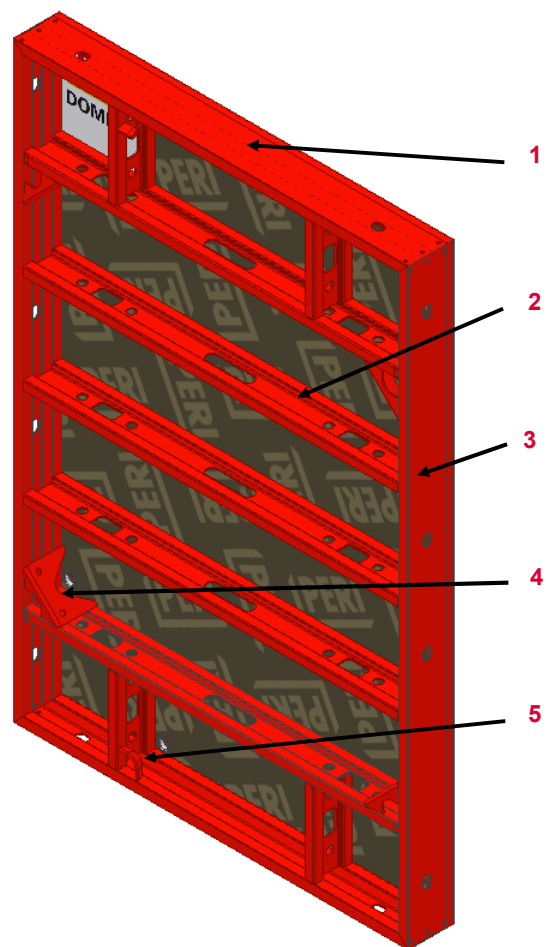

1	Rövid oldalprofil	
2	Merevítő borda	
3	Hosszú oldalprofil	
4	Átkötést megvezető fül	108556
5	D-Átkötést megvetőzető fül	740473

PERI Bérleti kritériumok

DOMINO



Cikk	Cikkszám
D 250x100	066020
D 250x75	066022
D 250x50	066025
D 250x35	125501
D 250x25	066026
DM 250x75 variábilis	066024
D 150x100	124498
D 150x75	124504
D 150x50	124510
D 150x35	124517
D 150x25	124523
DM 150x75 variábilis	124538

Cikk	Cikkszám
D 125x100	066040
D 125x75	066041
D 125x50	066043
D 125x35	125494
D 125x25	066044
DM125x75 variábilis	066042
D 75x25	066064
D 75x35	125486
D 75x50	066063
D 75x75	066061
D 75x100	066060
DM 75x75 variábilis	066062

PERI Bérleti kritériumok

DOMINO



Domino alu keretváz

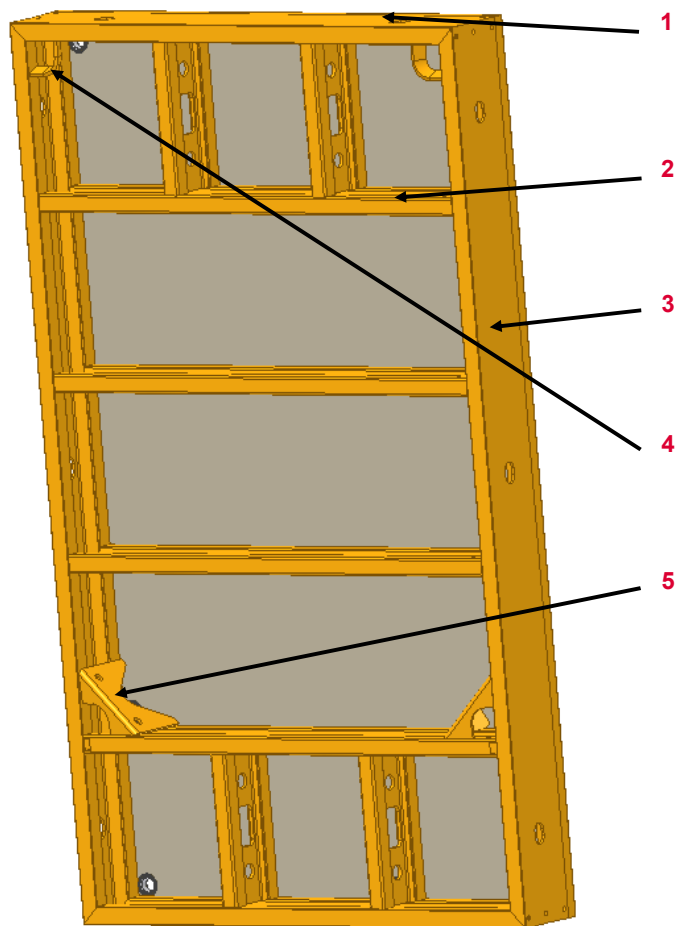

Sorsz.	Megnevezés	Cikkszám
1	Rövid oldalprofil	
2	Merevítő borda	
3	Hosszú oldalprofil	
4	D-Átkötést megvetőzető fül	740474
5	Átkötést megvetőzető fül Alu	108567

Cikk	Cikkszám
DA 125x 100, Alu	066050
DA 125x 75, Alu	066051
DA 250x 100, Alu	066021
DA 250x 75, Alu	066023

Keret	Leírás	Instrukció	Fizetési kondíció	Típus
-------	--------	------------	-------------------	-------

24.01 Elem elgörbült



- $> 8 \text{ mm}$



24.02 Az elem az átlós vonal mentén el van görbülve, ellenőrzése átlós méréssel

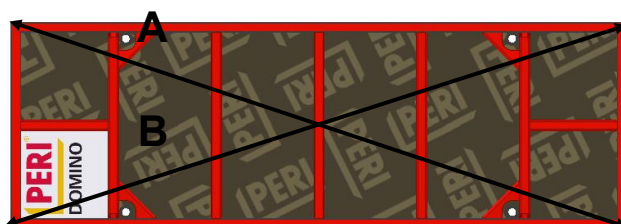

- Eltérés A és B között $> 5 \text{ mm}$



PERI Bérleti kritériumok

DOMINO











keret	Leírás	Instrukció	Fizetési kondíció	Típus
	24.03 Deformálódott profilok	Ezután a hegesztés ellenőrzése	088244	
	24.03.01 A profil behorpadt			
	<ul style="list-style-type: none"> ■ ≤ 8 mm mély ■ vagy < 8 mm mély 		088027	
	24.04 A profil széle deformálódott			
	<ul style="list-style-type: none"> ■ ≤ 3 mm ■ > 3 mm 		088244	

PERI Bérleti kritériumok

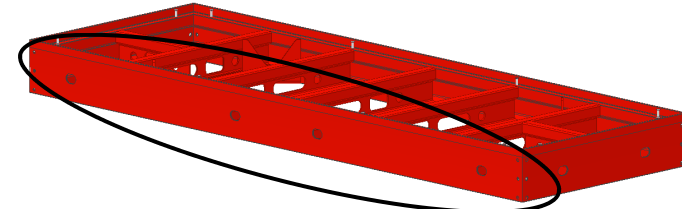
DOMINO

















Keret	Leírás	Instrukció	Fizetési kondíció	Típus
	<p>24.05 Rövid oldalprofil deformált, görbült</p> <ul style="list-style-type: none">■ A DRS –zár csatlakoztatása már nem lehetséges			
	<p>24.06 Hosszú oldalprofil deformált, görbült</p> <ul style="list-style-type: none">■ A DRS –zár (kapocs) csatlakoztatása már nem lehetséges			

PERI Bérleti kritériumok

DOMINO















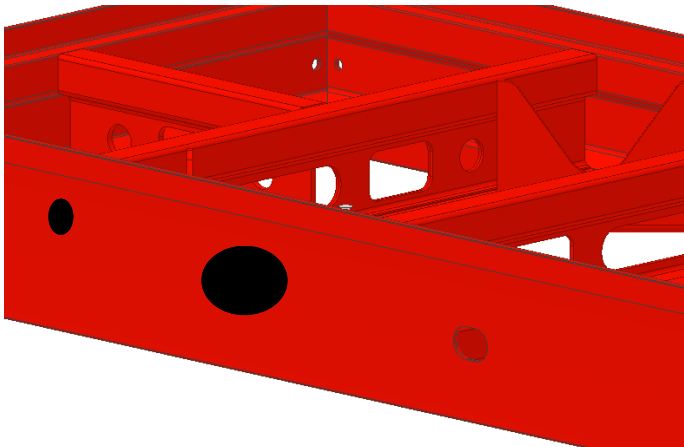

Keret	Leírás	Instrukció	Fizetési kondíció	Típus
	24.07 Merevítő borda meggörbült, deformálódott			
	<ul style="list-style-type: none"> ■ ≤ 3 mm 			
	<ul style="list-style-type: none"> ■ > 3 mm ≤ 10 mm 			088244 
<ul style="list-style-type: none"> ■ > 10 mm 				
	24.08 Megvezető fül elveszett/levágták			

PERI Bérleti kritériumok

DOMINO



Keret	Leírás	Instrukció	Fizetési kondíció	Típus
	<p>24.09 Hegesztés szakadt a tábla szélén vagy a merevítőbordánál</p>		 088028	
	<p>24.10 Lyukak a profilban</p>	<p>■ ≤ Ø 5 mm</p> 		
	<p>■ > Ø 5 mm ≤ 15 mm</p>		 088028	
	<p>■ > 15 mm</p>			

PERI Bérleti kritériumok

DOMINO



DISE fix sarok

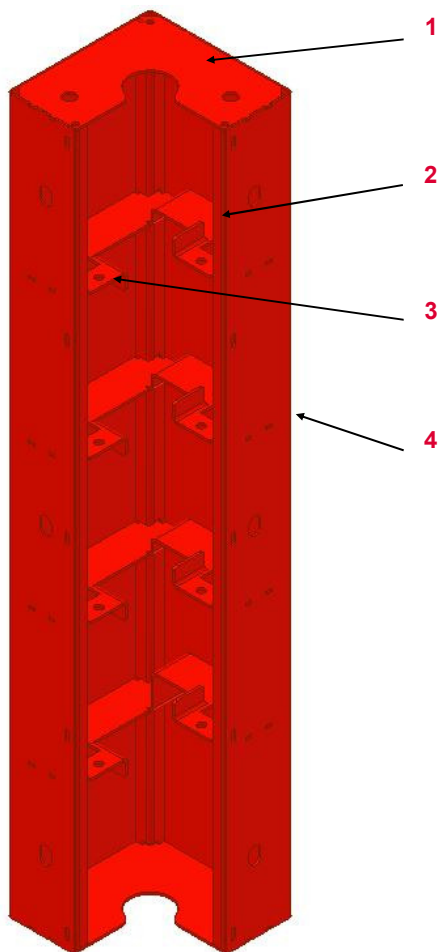

Sorsz.	Megnevezés	Cikkszám
--------	------------	----------

1	Sarok talplemez	
---	-----------------	--

2	Profil-él	
---	-----------	--

3	Merevítő	
---	----------	--

4	Zsaluzat héja	
---	---------------	--

Cikk	Cikkszám
------	----------

DISE Fix sarok 125	126280
--------------------	--------

DISE Fix sarok 150	126286
--------------------	--------











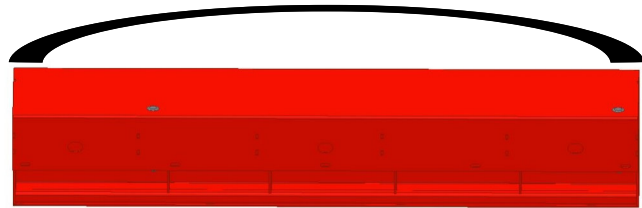

DISE Fix sarok 250	126242
--------------------	--------

DISE Fix sarok 75	126274
-------------------	--------

PERI Bérleti kritériumok

DOMINO



DISE	Leírás	Instrukció	Fizetési kondíció	Típus
	24.11 Domború profillemez			
	24.12 Profil hajlított ■ > 8 mm			
	24.13 Horpadás a zsalufelületen ■ > 3 mm			088027 

PERI Bérleti kritériumok

DOMINO



Csuklós sarok

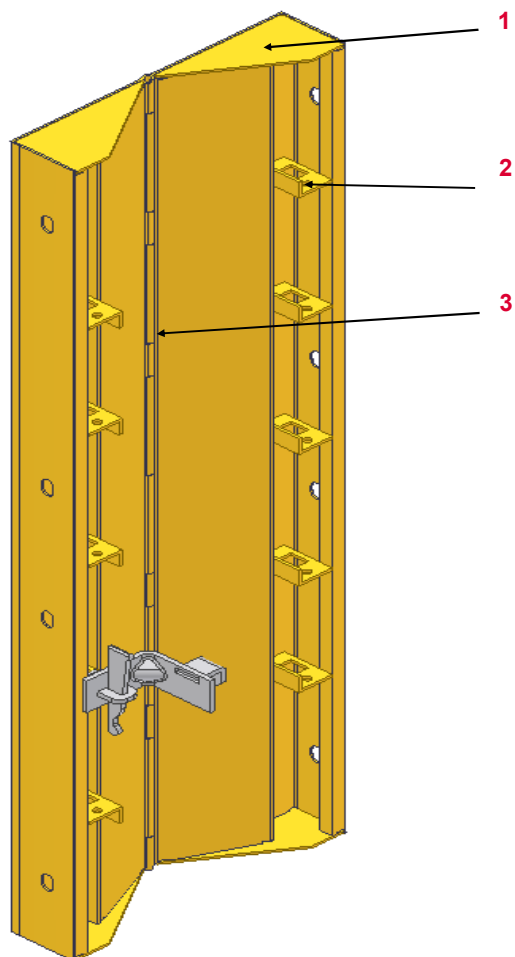

Sorsz.	Megnevezés	Cikkszám
1	Sarok talplemez	750057
2	Retesz rögzítő	750058
3	Zsanér	

Cikk	Cikkszám
DGE Csuklós sarok 125	066047
DGE Csuklós sarok 150	124605
DGE Csuklós sarok 250	066029
DGE Csuklós sarok 75	066067

Csuklós sarok	Leírás	Instrukció	Fizetési kondíció	Típus
	24.14 Profil hajlott <ul style="list-style-type: none"> ■ > 5 mm 	 Ha lehetséges	 088244	
	<ul style="list-style-type: none"> ■ Ha nem lehetséges 			
	24.15 Nem megfelelően működik <ul style="list-style-type: none"> ■ Zsanér tisztítása és olajozása 			
	<ul style="list-style-type: none"> ■ Funkciójában akadályozott 			

Csuklós sarok	Leírás	Instrukció	Fizetési kondíció	Típus
	24.16 A sarok talplemez deformálódott			
	<ul style="list-style-type: none"> ■ Keret egyengetés, ha lehetséges 		088027	
	<ul style="list-style-type: none"> ■ Vagy ha helyrehozhatatlan 			
	24.17 Retsesz rögzítő sérült			
	24.18 Horpadt zsalufelület			
	<ul style="list-style-type: none"> ■ < 3 mm 			
	<ul style="list-style-type: none"> ■ 3-10mm 		088027	
	<ul style="list-style-type: none"> ■ >10mm 			

PERI Bérleti kritériumok

DOMINO



Falbetét	Sorsz.	Megnevezés	Cikkszám
----------	--------	------------	----------

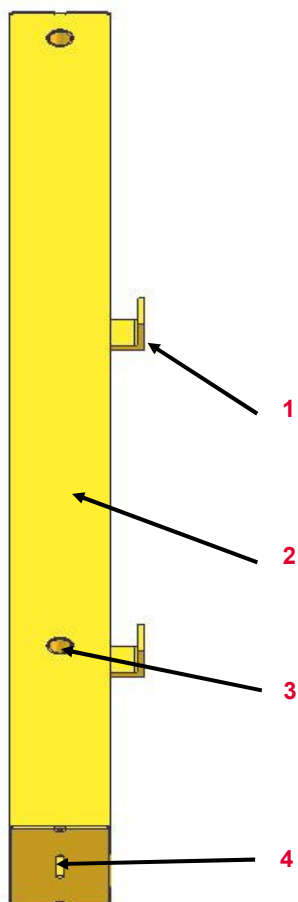

























1	DWD-betét rögzítő fül	770257
2	Zsaluzófelület	
3	DWD-távtartóhévely	770258
4	DWDA/10-betét TA AL	101959











Cikk	Cikkszám
Domino DWD falbetét 125x10	101964
Domino DWD falbetét 125x5	066048
Domino DWD falbetét 150/5	125944
Domino DWD falbetét150/10	125660
Domino DWD falbetét 250x10	101986
Domino DWD falbetét 250x5	066030
Domino DWD falbetét 75x5	066068

PERI Bérleti kritériumok

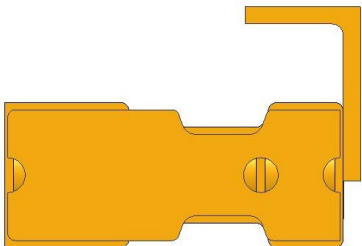
DOMINO

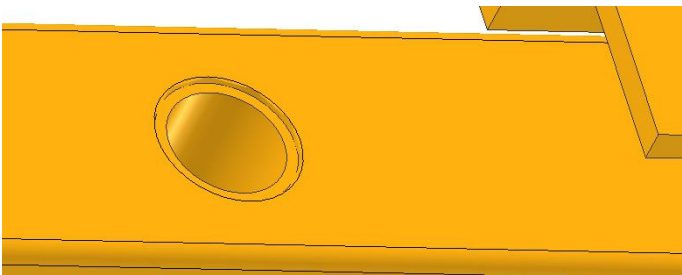

Falbetét	Leírás	Instrukció	Fizetési kondíció	Típus
	24.19 Profil elgörbült <ul style="list-style-type: none"> ■ > 8 mm 			
	24.20 Zsaluzó felület deformálódott <ul style="list-style-type: none"> ■ > 3 mm ≤ 10 mm 			
	<ul style="list-style-type: none"> ■ Vagy > 10 mm 			
	24.21 Deformálódott takarólemez <ul style="list-style-type: none"> ■ A hegesztés nem sérült 		 088244	
	<ul style="list-style-type: none"> ■ Vagy a hegesztés sérült 		 088250	
	24.22 Lyuk a profilban <ul style="list-style-type: none"> ■ ≤ 3 cm 			
	<ul style="list-style-type: none"> ■ > 3 cm 			

Falbetét	Leírás	Instrukció	Fizetési kondíció	Típus
	24.23 Kampó deformálódott			
	<ul style="list-style-type: none"> ■ ≤ 10 mm ■ > 10 mm 	 	 088244  088258	 
	24.24 Kampó hiányzik		 088258	
	24.25 Cső sérült / használhatatlan			

PERI Bérleti kritériumok

DOMINO



DSE kizsaluzó elem

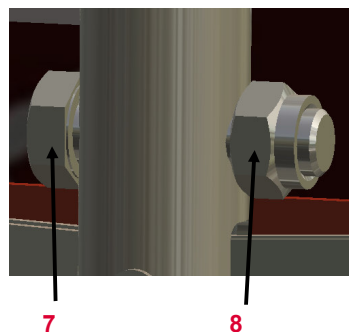
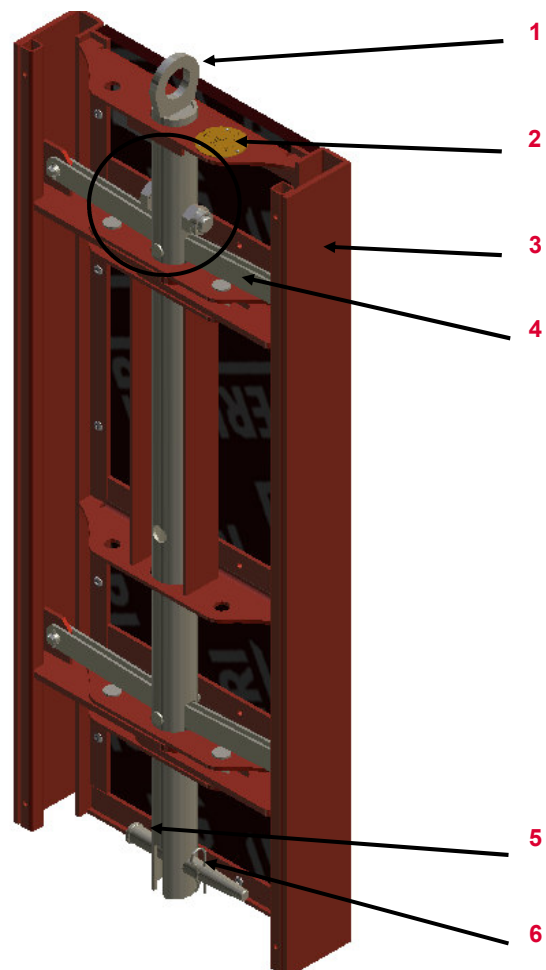















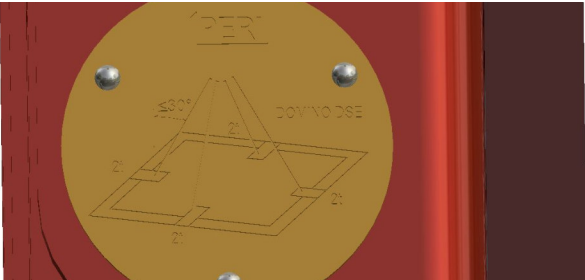

Sorsz.	Megnevezés	Cikkszám
1	Daru csatlakozó fül	111598
2	Információs tábla	123488
3	Oldalprofil	
4	Emelőkar	111582
5	Csap	111567
6	Sasszeg	018060
7	Csavar M24x 90	111571
8	SKT-Anya M24	105032

Cikk	Cikkszám
Domino kizsaluzó elem DSE 125	111655
Domino kizsaluzó elem DSE 275	111603
Domino kizsaluzó elem DSE 300	111617

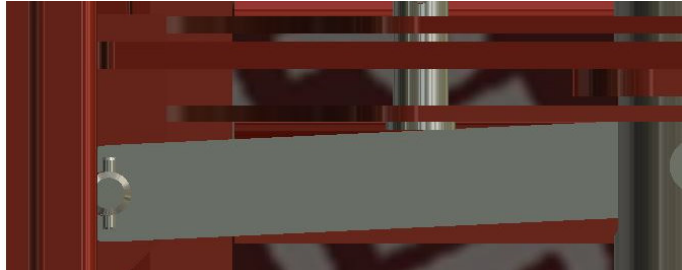
PERI Bérleti kritériumok

DOMINO









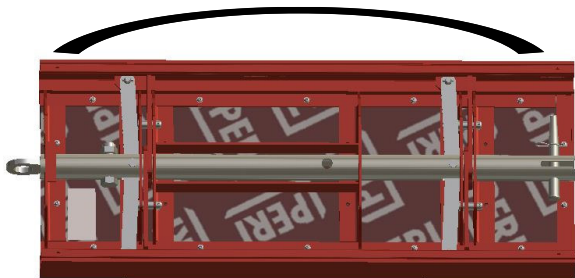

Kizsaluzó elem	Leírás	Instrukció	Fizetési kondíció	Típus
	24.26 Daruszem <ul style="list-style-type: none"> ■ Deformálódott 		 088244	
	<ul style="list-style-type: none"> ■ Vagy törött 	 111598		
	24.27 Információs tábla olvashatatlan / hiányzik	 123488		
	24.28 Emelőkar <ul style="list-style-type: none"> ■ Deformálódott 		 088244	
	<ul style="list-style-type: none"> ■ Vagy használhatatlan 	 111582		

PERI Bérleti kritériumok

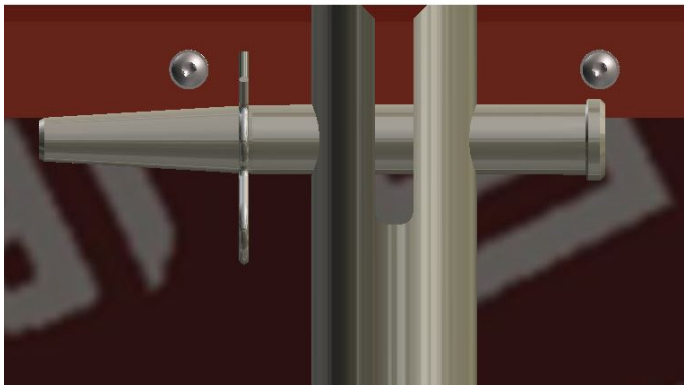
DOMINO



Kizsaluzó elem	Leírás	Instrukció	Fizetési kondíció	Típus
	24.29 Oldalsó merevítő elgörbült		 088244	
	24.30 Csap hiányzik	 111567 (Csap) 018060 (Sasszeg)		

PERI Bérleti kritériumok

DOMINO



DSE kizsaluzó elemhez orsó (111665)	Sorszám	Megnevezés	Cikkszám
-------------------------------------	---------	------------	----------

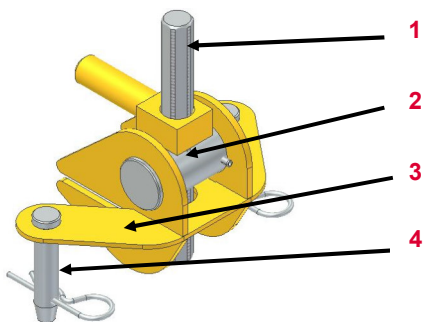

1	Orsó	111658
2	Menetes csap	111664
3	Karom	
4	Csap	105822

Sérülés	Leírás	Instrukció	Fizetési kondíciók	Típus
---------	--------	------------	--------------------	-------

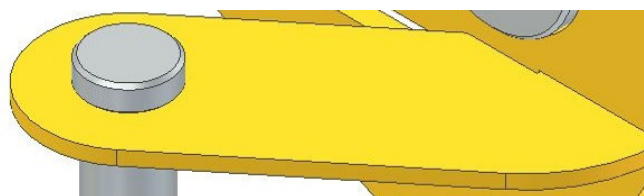

24.31 Karom deformálódott



088244

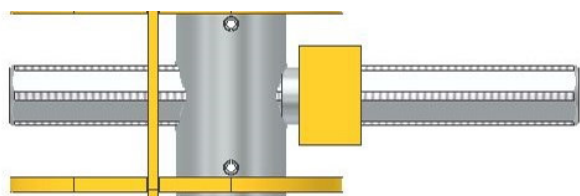

24.32 Orsó/ menetes csap nem funkcionál

■ Ha lehetséges



■ Vagy ha nem lehetséges



088289



PERI Bérleti kritériumok

DOMINO





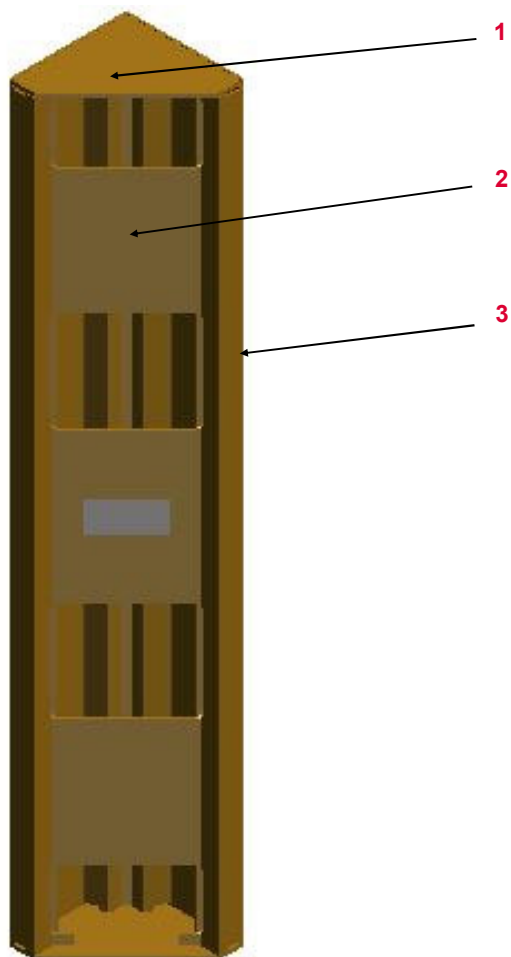









Külső sarok DAW

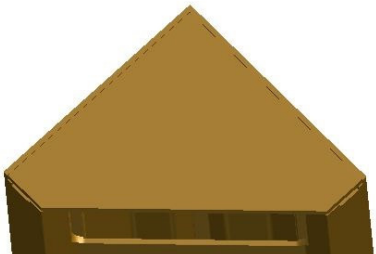

Sorsz.	Megnevezés	Cikkszám
1	Saroklemez	
2	Merevítő lemez	
3	Oldal profil	

Cikk	Cikkszám
Külső sarok DAW 75	066066
Külső sarok DAW 125	066046
Külső sarok DAW 150	124608
Külső sarok DAW 250	066028

Külső sarok	Leírás	Instrukció	Fizetési kondíció	Típus
	<p>24.33 Oldal profil horpadása</p> <p>■ > 3 mm</p>		 088244	
	<p>24.34 Merevítő lemez használhatatlan</p>			
	<p>24.35 Saroklemez horpadt</p>		 088250	

PERI Bérleti kritériumok

DOMINO



Domino végzáró AT

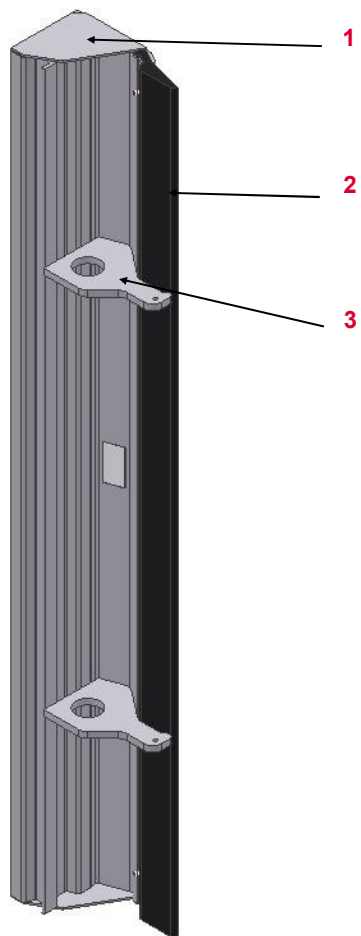















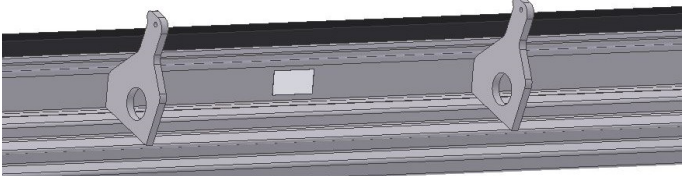



Sorsz.	Megnevezés	Cikkszám
1	Borítólemez	725011
2	Tömítő profil	
3	Kampó	100781

Cikk	Cikkszám
DOMINO VÉGZSALUZÓ AT 125x3	101934
DOMINO VÉGZSALUZÓ AT 125x5	108856
DOMINO VÉGZSALUZÓ AT 205x3	101927
DOMINO VÉGZSALUZÓ AT 205x5	108855
DOMINO VÉGZSALUZÓ AT 275x3	106203
DOMINO VÉGZSALUZÓ AT 275x5	108857

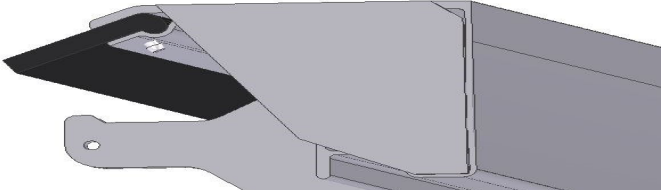
PERI Bérleti kritériumok

DOMINO



Domino végzáró AT	Leírás	Instrukció	Fizetési kondíció	Típus
	<p>24.36 Tömítő profil szakadt hiányos</p> <ul style="list-style-type: none"> ■ > 3 mm mély 			
	<p>24.37 Kampó törött vagy hiányzik</p>		 088154	
	<p>24.38 Profil meghajlott</p> <ul style="list-style-type: none"> ■ > 8 mm 			
	<p>24.39 Borítólemez deformálódott</p> <ul style="list-style-type: none"> ■ > 3 mm ≤10 mm 		 088244	
	<ul style="list-style-type: none"> ■ Vagy > 10 mm 		 088250	

PERI Bérleti kritériumok

DOMINO





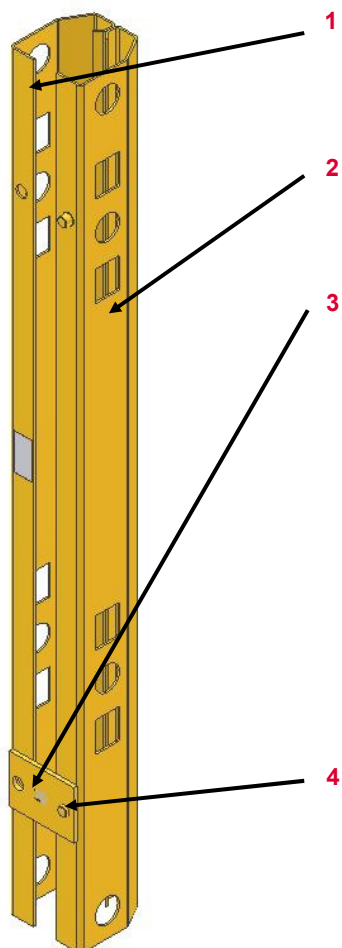



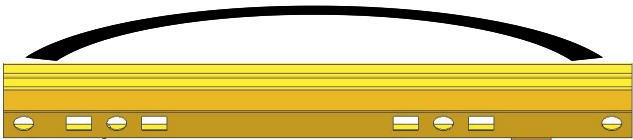

DOMINO Végzáró MTF



Sorsz.	Megnevezés	Cikkszám
1	Középső rész jobbra	725011
2	Középső rész balra	
3	Lemez 20	101804
4	Csavar	101215















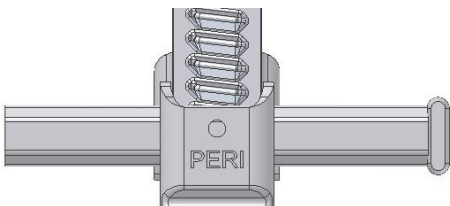

Cikk	Cikkszám
DOMINO VÉGZÁRÓ MTF 125 x 20	101935
DOMINO VÉGZÁRÓ MTF 125 x 24/25	101936
DOMINO VÉGZÁRÓ MTF 125 x 30	101937
DOMINO VÉGZÁRÓ MTF 125 x 35/36	101940
DOMINO VÉGZÁRÓ MTF 250 x 20	101928
DOMINO VÉGZÁRÓ MTF 250 x 24/25	101929
DOMINO VÉGZÁRÓ MTF 250 x 30	101930
DOMINO VÉGZÁRÓ MTF 250 x 35/36	101931

Végzáró MTF	Leírás	Instrukció	Fizetési kondíció	Típus
	24.40 Profil görbült vagy deformált ■ > 8 mm			
	24.41 Lemez elgörbült / használhatatlan		 088166	

PERI Bérleti kritériumok

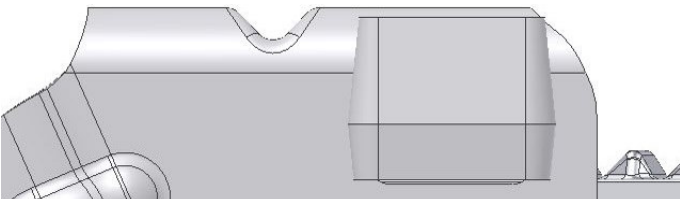
DOMINO



Kapocs DRS (066080)	Leírás	Instrukció	Fizetési kondíció	Típus
	24.42 A kapocs szétesett		 088031	
	24.43 A karom deformálódott		 088032	
	24.44 Az ék nem funkcionál			
	24.45 Az ütőfelület törött, repedt erő hatására			

PERI Bérleti kritériumok

DOMINO



Domino DKS ékes zár (066081)	Sorszám	Megnevezés	Cikkszám
------------------------------	---------	------------	----------

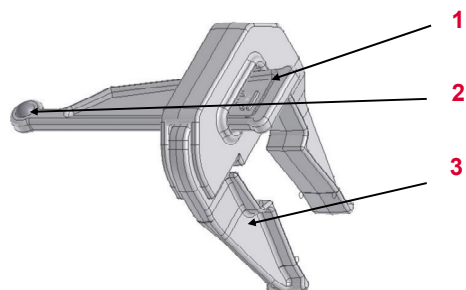

1	Ék	100703
2	Hasított ék	107521
3	Karom	

Sérülés	Leírás	Instrukció	Fizetési kondíciók	Típus
---------	--------	------------	--------------------	-------

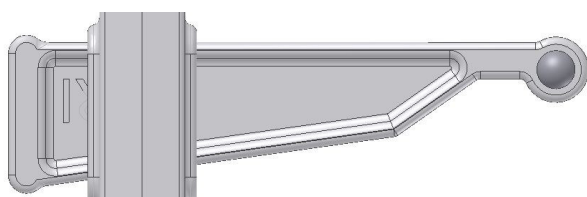

24.46 Ék hiányzik

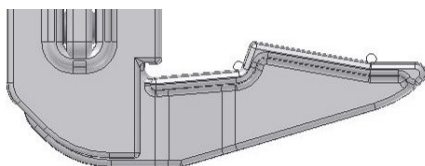

24.47 Karom deformálódott



PERI Bérleti kritériumok

DOMINO



DOMINO DAR 80 kiegyenlítő heveder (066084)	Sorszám	Megnevezés	Cikkszám
--	---------	------------	----------

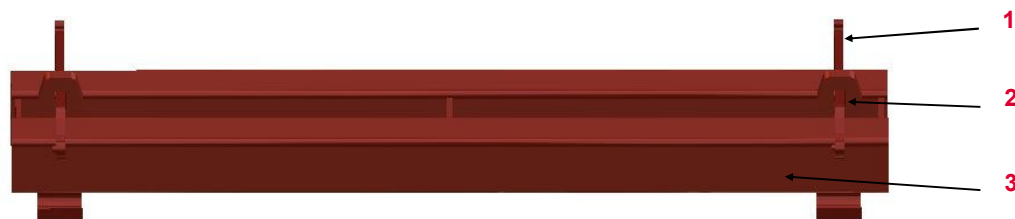

1	Ék	723318
2	Rögzítő fül	723321
3	Profil	

Sérülés	Leírás	Instrukció	Fizetési kondíciók	Típus
---------	--------	------------	--------------------	-------

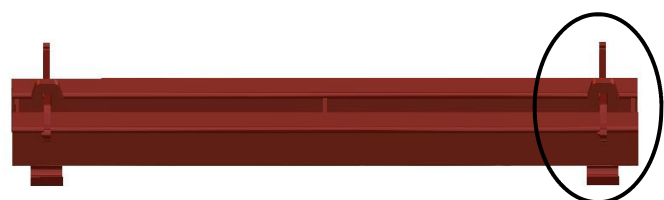

24.48 Rögzítő fül és/vagy ék sérülés / hiány



088259



24.49 Profil deformálódott





















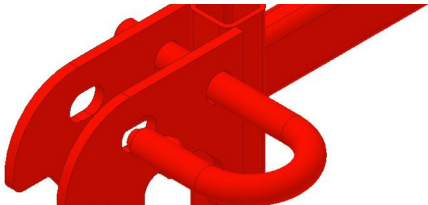

■ > 8 mm



PERI Bérleti kritériumok

DOMINO

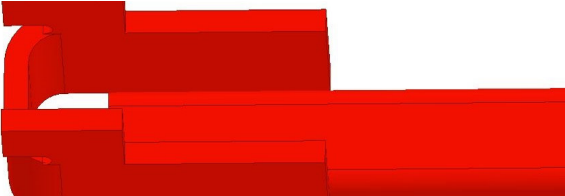

Domino DG 85 betonozó konzol (066085)	Leírás	Instrukció	Fizetési kondíció	Típus
	24.50 Repedt hegesztés <ul style="list-style-type: none"> ■ Az anyag deformációjával ■ Vagy anyag deformációja nélkül 	 	 	 
	24.51 Kampó deformálódott <ul style="list-style-type: none"> ■ Ha lehetséges ■ Vagy ha nem lehetséges 	 	 088244 	 
	24.52 A korláttartó szelvény deformálódott <ul style="list-style-type: none"> ■ Ha lehetséges ■ Vagy ha nem lehetséges 	 	 088244 	 
	24.53 Hajlított rész		 088244	
				

PERI Bérleti kritériumok

DOMINO



HSGP betonozó konzol korláttartó DOMINO (106877)

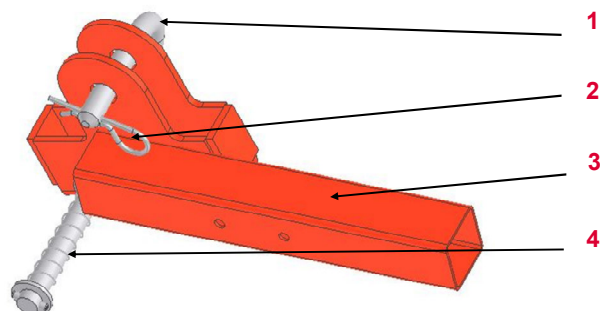

Sorszám	Megnevezés	Cikkszám
1	Csap	721814
2	Sasszeg	018060
3	Alaptest	
4	Kompressziós rugó	721816

Sérülés	Leírás	Instrukció	Fizetési kondíciók	Típus
---------	--------	------------	--------------------	-------

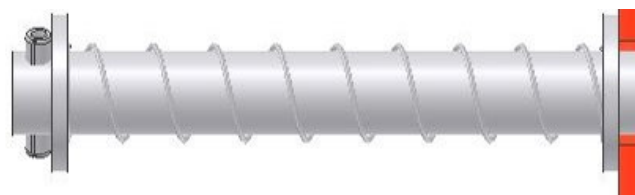

24.54 Rugó elveszett



721816 („Kompressziós rugó“)
711074 (Alátét)
710912 (Hasított ék)



088264

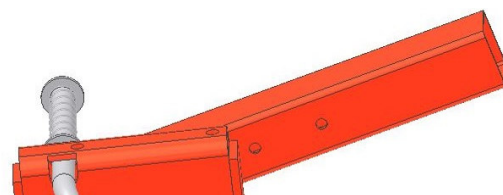

24.55 Az alaptest deformálódott













088244



PERI Bérleti kritériumok

DOMINO













HSGP-2 (116292)	Leírás	Instrukció	Fizetési kondíció	Típus
	24.56 Rögztítő fül deformálódott, hiányzik	 115673	 088227	
	24.57 Tartó fül törött			
	24.58 Görbült, deformálódott ■ > 10 mm			

PERI Bérleti kritériumok

DOMINO



















DOMINO DSR szállító rakonca (066094)	Leírás	Instrukció	Fizetési kondíció	Típus
	<p>24.59 Törött a hegesztés a retesznél</p> <ul style="list-style-type: none"> ■ Erőhatás következtében sérült ■ Vagy erőhatás nélkül törött (elhasználódott) 	 	 	 
	<p>24.60 Típus tábla hiányzik vagy olvashatatlan</p>	 750059 (típus tábla) 710217 (szegecs)		

PERI bérleti kritériumok

Magyarázat



Ikon	Jelentés	Ikon	Jelentés	Ikon	Jelentés
	Nem OK — kislejtezendő		Ügyfélnek leszámházandó		Optikai kár
	OK– marad a bérleti parkban		Nincs számlázás		Funkcionális sérülés
	Selejt anyag – biztonsági okokból az anyagot		Anyagot levágni		Funkcionális sérülés — anyag kiadása nem engedélyezett
	Javítás az előírások szerint		Anyagot megjelölni		Statikai sérülés — anyag kiadása nem engedélyezett
	Hideg egyenetés — utána a varratokat és a		Sérült anyag cseréje		
	Javítás gazdaságosság függvényében		Hiányzó anyag pótlása		
